



Microwave Oven

User Manual



MOC 20130 SFB

EN

CONTENTS

1 Important safety and environmental instructions 4

- 1.1 Safety warnings 4
- 1.2 Compliance with the WEEE Directive and Disposing of the Waste Product: . 9
- 1.3 Compliance with RoHS Directive . 9
- 1.4 Package information 9
- 1.5 Plug Wiring 10

2 Your microwave oven 11

- 2.1 Overview 11
- 2.2 Technical data. 11

3 Installation and connection 12

- 3.1 Installation 12
- 3.2 Radio interference. 12
- 3.3 Microwave cooking principles . . 12
- 3.4 Grounding instructions 12
- 3.5 Utensils guide 13

4 Operation 14

- 4.1 Control panel 14
- 4.2 Operation 14
- 4.3 Setting the clock. 15
- 4.4 Microwave cooking 15
- 4.5 Time defrost 15
- 4.6 Weight defrost 15
- 4.7 Mute function 15
- 4.8 Child lock 15
- 4.9 Button adhesion protection 16
- 4.10 Auto cook. 16

5 Cleaning and care 17

- 5.1 Cleaning and care 17
- 5.2 Storage 17
- 5.3 Handling and transportation. . . . 18

6 Troubleshooting 18

Please read this user manual first!





Dear Valued Customer,

Thank you for preferring this Beko appliance. We hope that you get the best results from your appliance which has been manufactured with high quality and state-of-the-art technology. For this reason, please read this entire user manual and all other accompanying documents carefully before using the appliance and keep it as a reference for future use. If you handover the appliance to someone else, give the user manual as well. Follow the instructions by paying attention to all the information and warnings in the user manual.

Remember that this user manual may also apply to other models. Differences between models are explicitly described in the manual.

Meanings of the Symbols

Following symbols are used in various sections of this user manual:

	Important information and useful hints about usage.
	Warnings for dangerous situations concerning the safety of life and property.
	Warning for electric shock.
	Warning for hot surfaces.



This appliance has been produced in environmentally friendly facilities without harming the nature.

1 Important safety and environmental instructions

Important Safety Instructions Read Carefully And Keep For Future Reference

1.1 Safety warnings

This section contains safety instructions that will help protect from risk of fire, electric shock, exposure to leak microwave energy, personal injury or property damage. Failure to follow these instructions shall void any warranty.

- Beko Microwave Ovens comply with the applicable safety standards; therefore, in case of any damage on the appliance or power cable, it should be repaired or replaced by the dealer, service center or a specialist and authorized service alike to avoid any danger. Faulty or unqualified repair work may be dangerous and cause risk to the user.
- This appliance is intended to be used in household and similar applications such as:
 - Staff kitchen areas in shops, offices and other working environments;
 - Farm houses
 - By clients in hotels, and other residential type environments;
 - Bed and Breakfast type environments.
- It is not intended for industrial or laboratory use.
- Do not attempt to start the oven when its door is open; otherwise you may be exposed to harmful microwave energy. Safety locks should not be disabled or tampered with.
- The microwave oven is intended for heating food and beverages. Drying of food or clothing and heating of warming pads, slippers, sponges, damp cloth and similar may lead to risk of injury, ignition or fire.

1 Important safety and environmental instructions

- Do not place any object between the front side and the door of the oven. Do not allow dirt or cleaning agent remnants to build up on the closure surfaces.
- Any service works involving removal of the cover that provides protection against exposure to microwave energy must be performed by authorized persons/service. Any other approach is dangerous.
- Your product is intended for cooking, heating and defrost food at home. It must not be used for commercial purposes.
- Your oven is not designed to dry any living being.
- Do not use your appliance to dry clothes or kitchen towels.
- Do not use this appliance outdoors, bathrooms, humid environments or in places where the it can get wet.
- No responsibility or warranty claim shall be assumed for damages arising from misuse or improper handling of the appliance.
- Never attempt to dismantle the appliance. No warranty claims are accepted for damage caused by improper handling.
- Only use the original parts or parts recommended by the manufacturer.
- Do not leave this appliance unattended while it is in use.
- Always use the appliance on a stable, flat, clean dry, and non-slip surface.
- The appliance should not be operated with an external clock timer or separate remote control system.
- Before using the appliance for the first time, clean all parts. Please see the details given in the “Cleaning and Maintenance” section.
- Operate the appliance for its intended purpose only as described in this manual.
- Appliance becomes very hot while it is in use. Pay attention not to touch the hot parts inside the oven.

1 Important safety and environmental instructions

- Do not operate the oven empty.
- Cooking utensil may get hot due to the heat transferred from the heated food to the utensil. You may need oven gloves to hold the utensil.
- Utensils shall be checked to ensure that they are suitable for use in microwave ovens.
- Do not place the oven on stoves or other heat generating appliances. Otherwise, it may be damaged and the warranty becomes void.
- Steam may come out while opening the covers or the foil after cooking the food.
- The appliance and its accessible surfaces may be very hot when the appliance is in use.
- Door and outer glass may be very hot when the appliance is in use.
- Make sure that your mains power supply complies with the information supplied on the rating plate of the appliance.
- The only way to disconnect the appliance from the power supply is to remove the power plug from the power outlet.
- Use the appliance with a grounded outlet only.
- Never use the appliance if the power cable or the appliance itself is damaged.
- Do not use this appliance with an extension cord.
- Never touch the appliance or its plug with damp or wet hands.
- Place the appliance in a way so that the plug is always accessible.
- Prevent damage to the power cable by not squeezing, bending, or rubbing it on sharp edges. Keep the power cable away from hot surfaces and naked flame.
- Make sure that there is no danger that the power cable could be accidentally pulled or that someone could trip over it when the appliance is in use.

1 Important safety and environmental instructions

- Unplug the appliance before each cleaning and when the appliance is not in use.
- Do not pull the power cable of the appliance to disconnect it from its power supply and never wrap its power cable around the appliance.
- Do not immerse the appliance, power cable, or power plug in water or any other liquids. Do not hold it under running water.
- When heating food in plastic or paper containers, keep an eye on the oven due to the possibility of ignition.
- Remove the wire strings and/or metal handles of paper or plastic bags before placing bags to the oven.
- If smoke is observed, switch off or unplug the appliance if safe to do so and keep the door closed in order to stifle any flames.
- Do not use microwave oven for storage. Do not leave paper items, cooking material or food inside the oven when it is not being used.
- The contents of feeding bottles and baby food jars should be stirred or shaken and the temperature checked before consumption, in order to avoid burns.
- This appliance is a Group 2 Class B ISM equipment. Group 2 contains all ISM (Industrial, Scientific and Medical) equipment in which radio-frequency energy is intentionally generated and/or used in the form of electromagnetic radiation for the treatment of material, and spark erosion equipment.
- Class B equipment is suitable for use in domestic establishments and establishments directly connected to a low voltage power supply network.
- Do not use cooking oil in the oven. Hot oil may damage the components and materials of the oven, and it may even cause skin burns.
- Pierce food with thick crust such as potatoes, courgettes, apples and chestnuts.

1 Important safety and environmental instructions

- Appliance must be placed so that the rear side is facing the wall.
- Before moving the appliance, please secure the turntable to prevent damage.
- Eggs in their shell and whole hard-boiled eggs must not be heated in microwave ovens since they may explode, even after microwave heating has ended.

WARNING: If the door or door seals are damaged, the oven must not be operated until it has been repaired by a competent person.

WARNING: It is hazardous for anyone other than a competent person to carry out any service or repair operation which involves the removal of a cover which gives protection against exposure to microwave energy.

WARNING: Liquids and other foods must not be heated in sealed containers since they are liable to explode.

- The oven should be cleaned regularly and any food deposits removed.
- There should be min 20 cm free space above the top surface of the oven.
- Do not over-cook foods; otherwise, you may cause a fire.
- Do not use chemicals and steam assisted cleaners to clean the appliance.
- Extreme caution is advised when being used near children and persons who are restricted in their physical, sensory or mental abilities.
- This appliance can be used by the children who are at the age of 8 or over and by the people who have limited physical, sensory or mental capacity or who do not have knowledge and experience, as long as they are supervised with regard to safe use of the product or they are instructed accordingly or understand the risks of using the product. Children should not play with the appliance.

1 Important safety and environmental instructions

Cleaning and user maintenance procedures should not be performed by children unless they are controlled by their elders.

- Danger of choking! Keep all the packaging materials away from children.
- Due to excessive heat that arises in grill and combination modes, children should only be allowed to use these modes under supervision of an adult.
- Keep the product and its power cable so that they are inaccessible by children under 8 years old.
- Do not cook food directly on the glass tray. Put the food in / on appropriate kitchen utensils before placing them in the oven.
- Metallic containers for food and beverages are not allowed during microwave cooking. Otherwise, sparking may occur.
- This product is not designed to be built-in. Do not place the product in a cabinet or box while it is in use.

1.2 Compliance with the WEEE Directive and Disposing of the Waste Product:

This product complies with EU WEEE Directive (2012/19/EU). This product bears a classification symbol for waste electrical and electronic equipment (WEEE).



This symbol indicates that this product shall not be disposed with other household wastes at the end of its service life. Used device must be returned to official collection point for recycling of electrical and electronic devices. To find these collection systems please contact to your local authorities or retailer where the product was purchased. Each household performs important role in recovering and recycling of old appliance. Appropriate disposal of used appliance helps prevent potential negative consequences for the environment and human health.

1.3 Compliance with RoHS Directive

The product you have purchased complies with EU RoHS Directive (2011/65/EU). It does not contain harmful and prohibited materials specified in the Directive.

1.4 Package information



Packaging materials of the product are manufactured from recyclable materials in accordance with our National Environment Regulations. Do not dispose of the packaging materials together with the domestic or other wastes. Take them to the packaging material collection points designated by the local authorities.

1 Important safety and environmental instructions

1.5 Plug Wiring

The moulded plug on this appliance incorporates a 13 A fuse. Should the fuse need to be replaced an ASTA approved BS1362 fuse of the same rating must be used. Do not forget to refit the fuse cover. In the event of losing the fuse cover, the plug must not be used until a replacement fuse cover has been fitted. Colour of the replacement fuse cover must be the same colour as that visible on the pin face of the plug. Fuse covers are available from any good electrical store.

Fiting a different plug

- As the colours of the wires in the mains lead of this appliance may not correspond with the coloured markings identifying the terminals on your plug, proceed as follows:
- Brown cable = L (Live)
- Blue cable = N (Neutral)
- Green/yellow cable must be connected to ground (E) \equiv line
- With the alternative plugs a 13 A fuse must be fitted either in the plug or adaptor or in the main fuse box. If in doubt contact a qualified electrician.

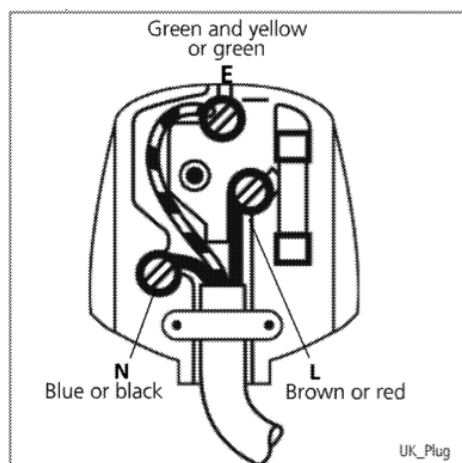

2 Your microwave oven

2.1 Overview

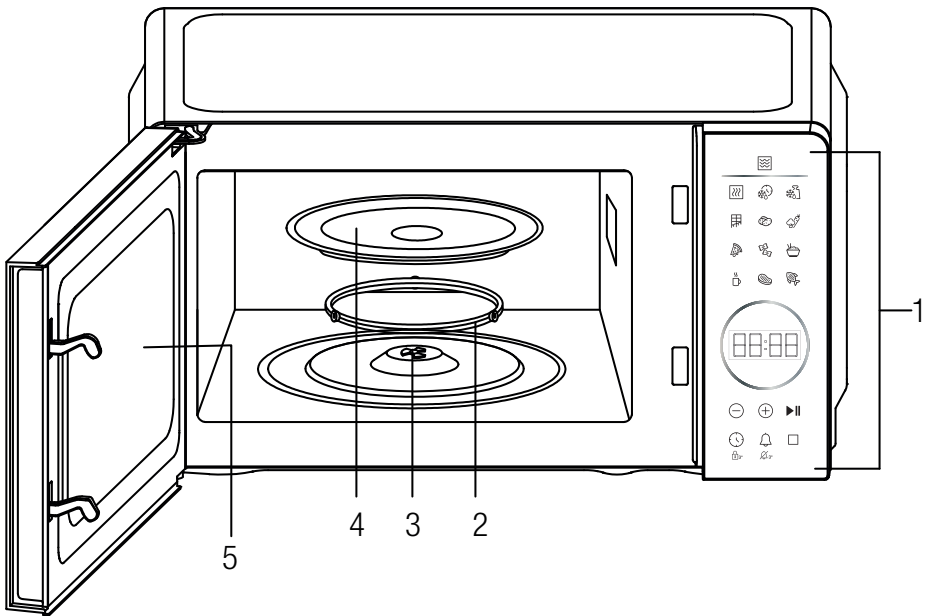

Controls and parts

1. Control panel
2. Roller ring
3. Shaft
4. Glass tray
5. Oven door

2.2 Technical data

Rated voltage	230-240V~, 50Hz
Rated input (Microwave)	1100W
Rated output	700W
Microwave frequency	2450MHz
Oven capacity	20 L

Technical and design modification rights are reserved.

Markings on the appliance or the values stated in other documents supplied with the product are values obtained under laboratory conditions as per relevant standards. These values may vary according to the usage of the appliance and ambient conditions.

3 Installation and connection

3.1 Installation

1. Make sure that all the packing materials are removed from the inside of the door.



WARNING: Check the oven for any damage, such as misaligned or bent door, damaged door seals and sealing surface, broken or loose door hinges and latches and dents inside the cavity or on the door. If there is any damage, do not operate the oven and contact qualified service personnel.

2. This microwave oven must be placed on a flat, stable surface to hold its weight and the heaviest food likely to be cooked in the oven.
3. Do not place the oven where heat, moisture, or high humidity are generated, or near combustible materials.
4. For correct operation, the oven must have sufficient airflow. Allow 20cm of space above the oven, 10cm at back and 5cm at both sides. Do not cover or block any openings on the appliance. Do not remove feet.
5. Do not operate the oven without glass tray, roller support, and shaft in their proper positions.
6. Make sure that the power supply cord is undamaged and does not run under the oven or over any hot or sharp surface.
7. The socket must be readily accessible so that it can be easily unplugged in an emergency.
8. Do not use the oven outdoors.

3.2 Radio interference

Operation of the microwave oven can cause interference to your radio, TV, or similar equipment.

When there is interference, it may be reduced or eliminated by taking the following measures:

1. Clean door and sealing surface of the oven.
2. Reorient the receiving antenna of radio or television.

3. Relocate the microwave oven with respect to the receiver.
4. Move the microwave oven away from the receiver.
5. Plug the microwave oven into a different outlet so that microwave oven and receiver are on different branch circuits.

3.3 Microwave cooking principles

1. Arrange food carefully. Place thickest areas towards outside of dish.
2. Watch cooking time. Cook for the shortest amount of time indicated and add more as needed. Food severely overcooked can smoke or ignite.
3. Cover foods while cooking. Covers prevent spattering and help foods to cook evenly.
4. Turn foods over once during microwave cooking to speed cooking of such foods as chicken and hamburgers. Large items like roasts must be turned over at least once.
5. Rearrange foods such as meatballs halfway through cooking both from top to bottom and from the center of the dish to the outside.

3.4 Grounding instructions

This appliance must be grounded. This oven is equipped with a cord having a grounding wire with a grounding plug. It must be plugged into a wall receptacle that is properly installed and grounded. In the event of an electrical short circuit, grounding reduces risk of electric shock by providing an escape wire for the electric current. It is recommended that a separate circuit serving only the oven be provided. Using a high voltage is dangerous and may result in a fire or other accident causing oven damage.



WARNING: Improper use of the grounding plug can result in a risk of electric shock.

3 Installation and connection



If you have any questions about the grounding or electrical instructions, consult a qualified electrician or service person.



Neither the manufacturer nor the dealer can accept any liability for damage to the oven or personal injury resulting from failure to observe the electrical connection procedures.

The wires in this cable main are colored in accordance with the following code:

Green and Yellow = EARTH

Blue = NEUTRAL

Brown = LIVE

3.5 Utensils guide

1. Microwave cannot penetrate metal. Only use utensils that are suitable for use in microwave ovens. Metallic containers for food and beverages are not allowed during microwave cooking. This requirement is not applicable if the manufacturer specifies size and shape of metallic containers suitable for microwave cooking.
2. Microwave cannot penetrate metal, so metal utensils or dishes with metallic trim should not be used.
3. Do not use recycled paper products when microwave cooking, as they may contain small metal fragments which may cause sparks and/or fires.
4. Round /oval dishes rather than square/oblong ones are recommend, as food in corners tends to overcook.
5. Narrow strips of aluminum foil may be used to prevent overcooking of exposed areas. But be careful don't use too much and keep a distance of 1 inch (2.54cm) between foil and cavity.

The list below is a general guide to help you select the correct utensils.

Cookware	Microwave
Heat-Resistant Glass	Yes
Non Heat-Resistant Glass	No
Heat-Resistant Ceramics	Yes
Microwave-Safe Plastic Dish	Yes
Kitchen Paper	Yes
Metal Tray	No
Metal Rack	No
Aluminum Foil & Foil Containers	No

4 Operation

4.1 Control panel

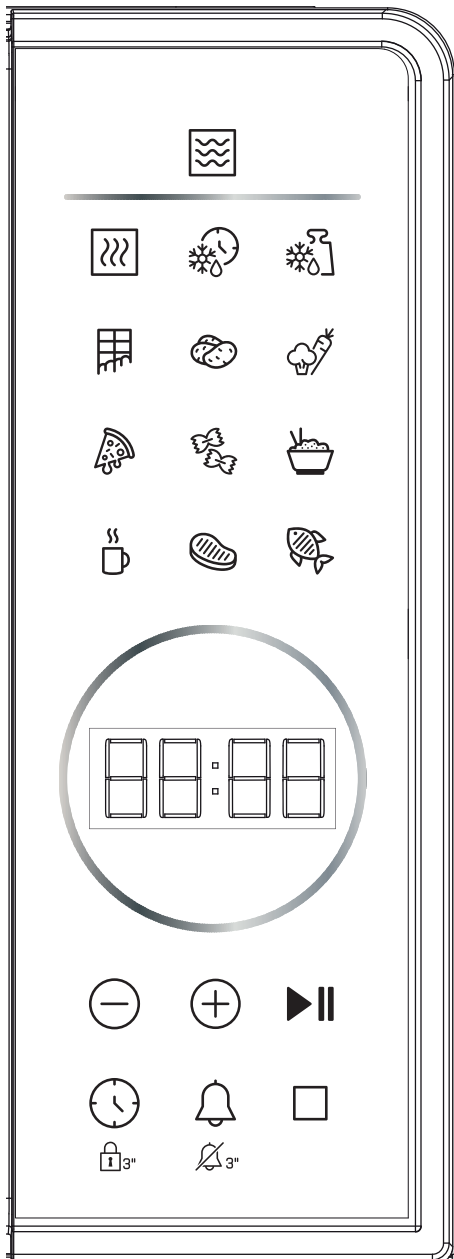

• Display

Cooking time, power, indicators and clock time are displayed.

• Power level -

Press to set microwave power level.

• Auto cook buttons

Instant settings to cook popular foods.

• Time defrost -

Press to defrost food based on time.

• Weight defrost -

Press to defrost food based on weight.

• -/+ ⊖ ⊕

Press to set time.

Start/Stop -

Press to start and stop cooking programs. Simply press it repeatedly to set cooking time and cook immediately at full power level.

Clock -

Press to set clock time. It is also used to set child lock.

Mute -

Use to set mute function.

Cancel -

Press cancel cooking program.

4.2 Operation

- When the oven first plugged in, the display will show "1:01".
- In the process of setting, broke about 25 seconds the oven will return to standby mode.
- During cooking, if press "START/STOP" button once or open the oven door, the program will be paused, then press "START/STOP" button once at the pausing state to resume.
- During cooking, press "CANCEL" button once, the program will be cancelled.

4 Operation

- After cooking end, the display will show End and beep will sound to remind user every two minutes until user press any button or open the door.

4.3 Setting the clock

This is a 12- or 24- hour clock, and you can select it by pressing “CLOCK” button.

1. In standby mode, press “CLOCK” button repeatedly to select 12- or 24- hour clock.
2. Press “-/+” buttons to set hour digit.
3. Press “CLOCK” button once.
4. Press “-/+” buttons to set minute digit.
5. Press “CLOCK” button to confirm.



During cooking, the current clock time can be seen by pressing “CLOCK”.

4.4 Microwave cooking

1. In standby mode, press “POWER LEVEL” button repeatedly to set power level.
2. Press “-/+” buttons to set cooking time. The time ranges from 30 seconds to 95 minutes.
3. Press “START/STOP” button to start.

Press “POWER LEVEL” button repeatedly to set power level:

Press POWER LEVEL button	Power (Display)
Once	100% (P100)
Twice	80% (P-80)
3 times	60% (P-60)
4 times	40% (P-40)
5 times	20% (P-20)
6 times	0% (P-00)



During cooking, you can check the current power level by pressing “POWER LEVEL” button. If you want to cook at full power level, omit the first step.

4.5 Time defrost

1. In standby mode, press “TIME DEFROST” button once.
2. Press “-/+” buttons to set defrosting time. The time ranges from 30 seconds to 95 minutes.
3. Press “START/STOP” button to start.

4.6 Weight defrost

The defrosting time and power level are automatically set once the food weight is programmed. The frozen food weight ranges from 100 g to 1800 g.

1. Press “WEIGHT DEFROST” button repeatedly to set food weight.
2. Press “START/STOP” button to start.



During defrosting, the system will pause to remind user to turn food over, after that, press “START/STOP” button to resume the defrosting.

4.7 Mute function

To set mute function: In standby mode, press and hold “MUTE” button for 3 seconds, the display will show “OFF” for 3 seconds. The button tone mute function has been opened.

To relieve mute function: In mute mode, press and hold “MUTE” button for 3 seconds, the display will show “on” for 3 second.

4.8 Child lock

The lock prevents unsupervised operation by children.

To set: In standby mode, press and hold “CLOCK” button for 3 seconds, then the oven will auto enter child lock mode and the lock indicator light will turn on. In the lock state, all buttons are disabled.

To cancel: Press and hold “CLOCK” button for 3 seconds to cancel the program.

4 Operation











4.9 Button adhesion protection

In any state, if any button on the control panel is adhesion for 1 minute, the program stops working immediately, the display shows "FAIL" and the system will sound beep. If the button is adhesion all the time, beep will sound every one minute. Any button is invalid at this time. After troubleshooting, press "CANCEL" button to return standby mode.

4.10 Auto cook

For the following food or cooking mode, it is not necessary to program the cooking power and time. It is sufficient to indicate the type of food that you wish to cook as well as the weight or servings of the food.

1. In standby mode, press corresponding menu button once or repeatedly to set food weight or servings.
2. Press "START/STOP" button to start.

Food	Note
 Chocolate (50 g, 100 g)	The result of auto cook depends on factors such as the shape and size of food, your personal preference as to the doneness of certain foods and even how well you happen to place food in the oven. If you find the result at any rate not quite satisfactory, please adjust the cooking time a little bit accordingly.
 Potato (230 g/serving, 1-2 servings)	
 Vegetable (200-600 g)	
 Pizza (150 g, 300 g, 450 g)	
 Pasta (100 g, 200 g, 300 g)	
 Rice (150-600 g)	
 Meat (200-600 g)	
 Fish (200-600 g)	
 Reheat (200-800 g)	
 Milk/Coffee (200 ml/cup, 1-3 cups)	

5 Cleaning and care

5.1 Cleaning and care



WARNING: Never use gasoline, solvent, abrasive cleaning agents, metal objects or hard brushes to clean the appliance.



WARNING: Never immerse the appliance or its power cable in water or in any other liquid.

1. Turn off the oven and remove the power plug from the wall socket before cleaning.
2. Keep the inside of the oven clean. When food splatters or spilled liquids adhere to oven walls, wipe with a damp cloth. Mild detergent may be used if the oven gets very dirty. Avoid the use of spray and other harsh cleaners as they may stain, streak or dull the door surface.
3. The outside surfaces should be cleaned with a damp cloth. To prevent damage to the operating parts inside the oven, water should not be allowed to seep into the ventilation openings.
4. Wipe the both sides of the door and window, the door seals and adjacent parts frequently with a damp cloth to remove any spills or splatters. Do not use abrasive cleaner.
5. A steam cleaner is not be used.
6. Do not allow the control panel to become wet. Clean with a soft, damp cloth. When cleaning the control panel, leave oven door open to prevent oven from accidentally turning on.
7. If steam accumulates inside or around the outside of the oven door, wipe with a soft cloth. This may occur when the microwave oven is operated under high humidity condition. And it is normal.
8. It is occasionally necessary to remove the glass tray for cleaning. Wash the tray in warm sudsy water or in a dishwasher.
9. The roller ring and oven floor should be cleaned regularly to avoid excessive noise. Simply wipe the bottom surface of the oven with mild detergent. The roller ring may be washed in mild sudsy water or dishwasher. When removing the roller ring from cavity floor for cleaning, be sure to replace in the proper position.
10. Remove odors from your oven by combining a cup of water with the juice and skin of one lemon in a deep microwaveable bowl, microwave for 5 minutes. Wipe thoroughly and dry with a soft cloth.
11. When it becomes necessary to replace the oven light, please consult a dealer to have it replaced.
12. The oven should be cleaned regularly and any food deposits removed. Failure to maintain the oven in a clean condition could lead to deterioration of the surface that could adversely affect the life of the appliance and possibly result in a hazardous situation.
13. Please do not dispose this appliance into the domestic rubbish bin; it should be disposed to the particular disposal center provided by the municipalities.
14. When the microwave oven with grill function is first used, it may produce slight smoke and smell. This is a normal phenomenon because the oven is made of a steel plate coated with lubricating oil, and the new oven will produce fumes and odor generated by burning the lubricating oil. This phenomenon will disappear after a period of using.

5.2 Storage

- If you do not intend to use the appliance for a long time, please store it carefully.
- Please make sure that the appliance is unplugged, cooled down and totally dry.
- Store the appliance in a cool and dry place.
- Keep the appliance out of the reach of children

5 Cleaning and care

5.3 Handling and transportation

- During handling and transportation, carry the appliance in its original packaging. The packaging of the appliance protects it against physical damages.
- Do not place heavy loads on the appliance or the packaging. The appliance may be damaged.
- Dropping the appliance will render it non-operational or cause permanent damage.

6 Troubleshooting

Problem	Possible solution
If the oven fails to operate	Check to ensure that the oven is plugged in securely. If it is not, remove the plug from the outlet, wait 10 seconds, and plug it in again securely.
	Check for a blown circuit fuse or a tripped main circuit breaker. If these seem to be operating properly, test the outlet with another appliance.
	Check to ensure that the control panel is programmed correctly and the timer is set.
	Check to ensure that the door is securely closed engaging the door safety lock system. Otherwise, the microwave energy will not flow into the oven.
If none of the above rectifies the situation, then contact a qualified technician. Do not try to adjust or repair the oven yourself.	

Product Guarantee

12 months breakdown and repair guarantee

Guarantor: **Beko plc, 1 Greenhill Crescent, Watford, Hertfordshire. WD18 8UF**

The guarantee does not in any way diminish your statutory or legal rights.

Your **microwave** has the benefit of our manufacturer's guarantee which covers the product for 12 months from the date of original purchase.

This gives you reassurance that if within that time, your **microwave** is proven to be defective because of either workmanship or materials, we will at our discretion either repair or replace your **microwave**.

The **microwave** must be correctly installed, located and operated in accordance with the instructions contained in the user manual. The guarantor disclaims any liability for accidental or consequential damage.

The Guarantee is subject to the following conditions:

- Documentary proof of the original purchase date is provided.
- The microwave has been installed and operated correctly and in accordance with our operating and maintenance instructions.
- The microwave is used only on the electricity supply on the rating plate.
- The microwave has only been used for normal domestic purposes.
- The microwave has not been altered, serviced, dismantled or otherwise interfered with by any person.
- The microwave is used in the United Kingdom or Republic of Ireland.
- Any parts removed during repair work or any product that has been replaced becomes our property.
- The guarantee is not transferrable if the product is resold.

The Guarantee does not cover:

- Transit, installation or delivery damage.
- Accidental damage.
- Misuse or abuse.
- Replacement of any consumable item or accessories. These include but are not limited to: plugs, cables, light bulbs, knobs, filters and flaps.
- Repairs or replacements required as a result of unauthorised repairs or inexpert installation that fails to meet the requirements contained in the user guide or instruction book.
- Repairs to products used in commercial or non-residential household premises.

How to obtain after sales service, help or general advice

Please keep your purchase receipt or other proof of purchase in a safe place as you will need to show us this document if your product requires attention within the guarantee period.

Please also record your product details below, which will allow you to access our services more quickly and help us identify your product. The model number is printed on the front of the user guide and the serial and model number is shown on your products rating plate.

Model number	Serial number	Purchased from	Date of purchase

Please call our UK based Customer Service department if you need help or advice from us:

United Kingdom and Northern Ireland: **0333 207 9710**

Republic of Ireland: **01 862 3411**

You can also contact us through our website: **www.beko.co.uk**

Arçelik A.Ş.
Karaağaç Caddesi No: 2-6, 34445,
Sütlüce, İstanbul, Türkiye

www.beko.com