

BDG 682 P

DOUBLE CAVITY OVEN

User Manual

Please read this manual first.

Dear Customer,

We would like you to obtain the best performance from your product that has been manufactured in modern facilities under strict quality control procedures. Therefore, we advise you to read through this User Manual carefully before using your product and keep it for future reference. If you hand over the product to someone else, deliver the User Manual as well.

The User Manual will help you use the product in a fast and safe way.

- Read the User Manual before installing and starting the product.
- You must strictly observe the safety instructions.
- Keep this User Manual within easy reach for future reference.
- Also read other documents supplied with the product.
Remember that this User Manual may also be applicable for several other models.
Differences between models are explicitly identified in the manual.

Explanation of symbols

Throughout this User Manual the following symbols are used:

 Important information or useful hints about usage.

 Warning for hazardous situations with regard to life and property.

 Warning for electric shock.

 Warning for risk of fire.

 Warning for hot surfaces.

Table of Contents

1	General information	4	5	How to use the hob	22
	Overview	4		General information on cooking.....	22
	Technical Data	5		How to use hobs.....	22
	Accessories supplied with the unit.....	5	6	How to operate the oven	24
	Injector table.....	7		General information on baking, roasting and grilling	24
2	Safety instructions	8		How to use the gas oven	25
	Basic safety instructions.....	8		Cooking times table.....	25
	Safety when working with electricity.....	9		How to operate the gas grill- Top oven	27
	Safety when working with gas	9		Cooking times table.....	28
	Intended use	10	7	Maintenance and care	29
	Safety for children	10		General information	29
	Disposal	10		How to clean the hob.....	29
	Disposing of packaging material	10		Cleaning the control panel.....	29
	Old equipment.....	11		Cleaning the oven	29
	Future transportation.....	11		Removal of top oven door	29
3	Installation	12		Removing the door inner glass	30
	Before installation	12		Replacing the oven lamp	31
	Installation and connection.....	13	8	Troubleshooting	32
	Gas conversion.....	16	9	Guarantee and Service	34
4	Preparation	21			
	Tips for saving energy	21			
	First cleaning of the appliance	21			
	Initial heating	21			

1 General information

Overview

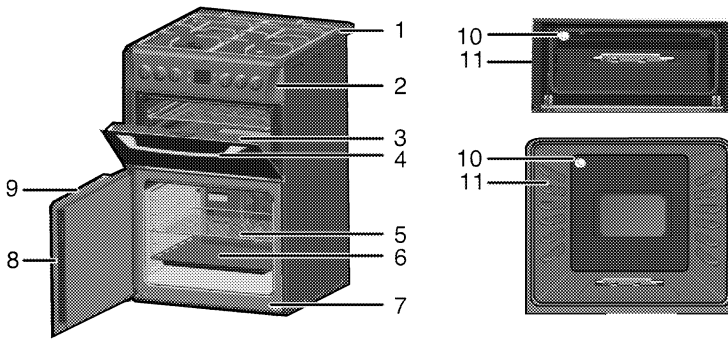

- | | | | |
|---|----------------|----|-----------------|
| 1 | Burners' plate | 7 | Rating plate |
| 2 | Control panel | 8 | Main oven door |
| 3 | Grill door | 9 | Handle |
| 4 | Handle | 10 | Lamp |
| 5 | Wire shelf | 11 | Shelf positions |
| 6 | Tray | | |

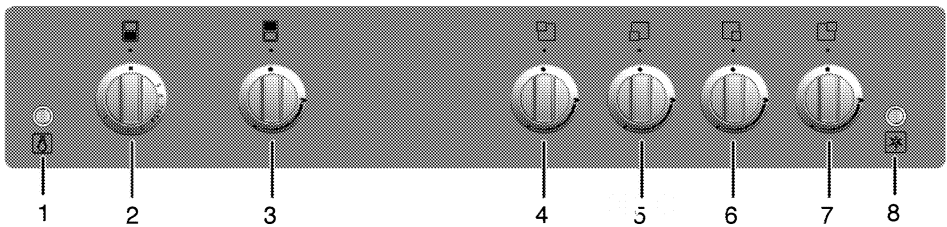

- | | | | |
|---|--------------------------------|---|-------------------------------|
| 1 | Lamp button | 6 | Auxiliary burner -Front right |
| 2 | Main oven thermostat knob | 7 | Normal burner- Rear right |
| 3 | Top oven/Grill thermostat knob | 8 | Ignition button |
| 4 | Normal burner-Rear left | | |
| 5 | Rapid burner- Front left | | |

Technical Data

GENERAL	
Outer dimensions (height/width/depth)	900 mm/600 mm/600 mm
Voltage/frequency	220-240 V ~ 50 Hz
Fuse protection	min. 13 A
Cable type / cross section	H05VV-FG 3 x 0,75 mm ² or equivalent
Cable length	max. 2 m
Gas device category	II _{2H3+}
Gas type/pressure	NG G 20/20 mbar
Total gas consumption	12,7 kW
Conversion to gas type/pressure ^s – optional	LPG G 30/28-30 mbar Propane 31/37 mbar
HOB	
Burners	
Rear left	Normal burner
Power	2000 W
Front left	Rapid burner
Power	2900 W
Front right	Auxiliary burner
Power	1000 W
Rear right	Normal burner
Power	2000 W
OVEN/GRILL	
Top oven	Grill oven
Grill power consumption	2.3 kW
Main oven	Gas oven
Oven power	2,5 kW
Inside illumination	15–25 W

** See *Installation*, page 12.

Accessories supplied with the unit

-  Accessories supplied can vary depending on the product model. All the accessories described in the user manual may not exist on your product.

Baking tray

Can be used for pastries, frozen foods and big roasts.

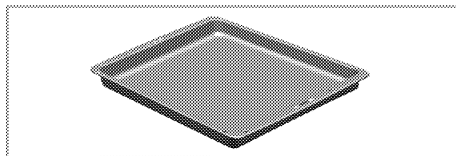

Deep roasting tray

Can be used for pastries, big roasts, foods with liquid content and during grilling as dripping pan.

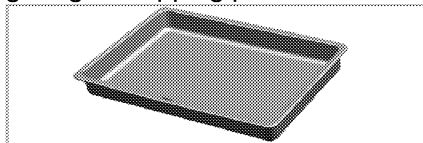

Pastry tray

It is recommended for pastries such as cookies and biscuits.

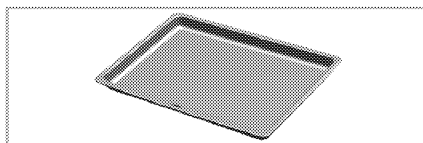

Small baking tray

Can be used for small portions. This baking tray is placed onto the wire shelf.

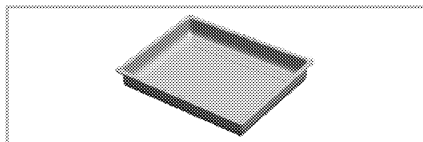

Wire shelf

Can be used for roasting and as deposit for baking, roasting and casserole dishes.

In order to get best cooking performance it should be used together with the wire shelf metal shield on the rear side.

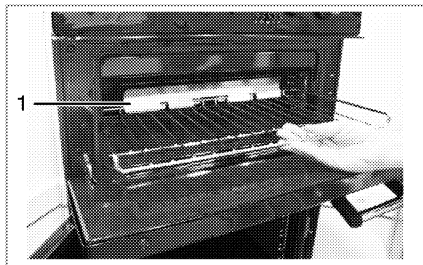

1 Metal shield

Metal shield should be attached on the rear upper side of wire shelf. Use the wire shelf as its bended side positioned on the front of the cavity and turned downside.

Small wire shelf (for use with supplied tray)

Can be used for grilling and fat collection within tray to prevent the oven from getting dirty.



Proper positioning of the wire shelf and tray on sliding shelves

Trays and wire shelves used with the sliding shelf (model dependant) must be positioned correctly with the inner edges of the shelf placed over the pins on the sliding shelf. This holds the shelf firmly in place".

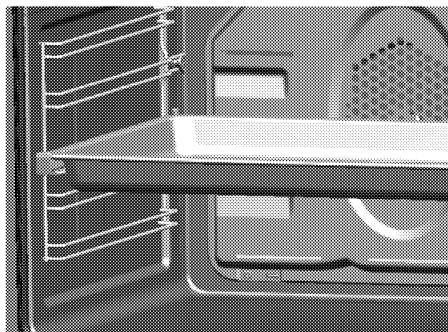

Heat shield

For grilling with the oven door open.
Protects the control panel and knobs
against heat and soiling.

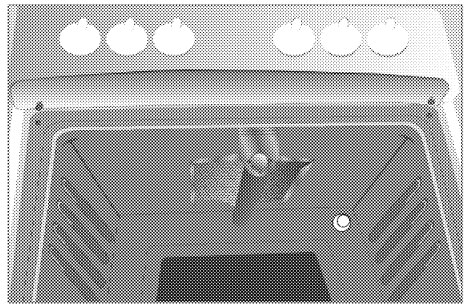

Injector table

Position hob zone	2000 W Rear left	2900 W Front left	1000 W Front right	2000 W Rear right
Gas type / Gas pressure				
G 20/20 mbar	103	115	72	103
G 30/28-30 mbar/ G 31/ 37 mbar	72	87	50	72
Gas type / Gas pressure-Top OVEN	Grill			
G 20/20 mbar	110			
G 30/28-30 mbar/ G 31/ 37 mbar	75			
Gas type / Gas pressure-Main OVEN	Gas oven			
G 20/20 mbar	115			
G 30/28-30 mbar / G 31/ 37 mbar	78			

call CUSTOMER SERVICES HELPLINE. 0845 600 4911 to order LPG injector kit.

2 Safety instructions

Basic safety instructions

- The manufacturer reserves its right to make changes in the technical specifications in order to improve the appliance quality without any prior notice. Figures included in this manual are for schematic purpose only and may not match exactly with your appliance. Values stated on the markings of the appliance or in other printed documents supplied with the appliance are obtained under laboratory conditions as per relevant standards. These values may vary according to the usage of the appliance and ambient conditions.
- This appliance is not intended for use by persons (including children) with reduced physical, sensory or mental capabilities, or lack of experience and knowledge, unless they have been given supervision or instruction concerning use of appliance by a person responsible for their safety.
Children should be supervised to ensure that they do not play with the appliance.
- Never use when judgement or coordination is impaired by the use of alcohol and/or drugs.
- Do not operate the appliance if it is defective or shows any visible damage.
- Do not carry out any repairs or modifications on the appliance. However, you may remedy some malfunctions; see *Troubleshooting*, page 32.
- Be careful when using alcoholic drinks in your dishes. Alcohol evaporates in high temperatures and may catch fire when it comes in contact with hot surfaces.
- Do not heat closed tins and glass jars in the oven. The pressure that would build up in the tin/jar would cause it to burst.
- Ensure that no flammable materials are adjacent to the appliance as the sides become hot during use.
- Do not leave empty pots or pans on plates that are switched on. They may get damaged.
- Since it may be hot, do not leave plastic or aluminum dishes on the surface of appliance. These kind of dishes should not be used to keep food either.
- Do not close the lid before the hob has cooled down sufficiently. In order to avoid any spillage from leaking down the back or into the oven, you must wipe the surface of the the lid before opening upright.
- Do not place baking trays, dishes or aluminium foil directly onto the bottom of the oven. The heat accumulation might damage the bottom of the oven. Keep all ventilation slots clear of obstructions.
- Appliance may be hot when it is in use. Never touch the hot burners, inner sections of the oven, heating elements etc. Keep children away!

- Always use heat-resistant gloves when putting or removing the dishes into/from your oven.
 - Don't use the cooker with front door glass removed.
 - Rear surface of the oven gets hot when it is in use. Gas / Electric connection should not touch the rear surface, otherwise the mains cable may get damaged. Do not trap the mains cable between the hot oven door and frame. Do not route the mains cable over the hot cooking section. Otherwise, cable insulation may melt and cause fire as a result of short circuit.
 - Check all controls on the appliance are switched off after use.
-  For the warranty to be valid, the appliance must be installed by a qualified person in accordance with current regulations.

Safety when working with electricity

- Any work on electric equipment and systems may only be carried out by authorized qualified persons.
- In case of any damage, switch off the appliance and disconnect it from the mains supply by removing the fuse or switching off the circuit breaker.
- Ensure that the fuse rating is correct.

Safety when working with gas

- Any works on gas equipment and systems may only be carried out by authorised qualified persons who are Gas Safe registered.

- "Prior to the installation, ensure that the local distribution conditions (nature of the gas and gas pressure) and the adjustment of the appliance are compatible."
- "This appliance is not connected to a combustion products or evacuation device. It shall be installed and connected in accordance with current installation regulations. Particular attention shall be given to the relevant requirements regarding ventilation;" *See Before installation, page 12*
- "The use of gas cooking appliance results in the production of heat and moisture in the room in which it is installed. Ensure that the kitchen is well ventilated: keep natural ventilation holes open or install a mechanical ventilation device (mechanical extractor hood). Prolonged intensive use of the appliance may call for additional ventilation, for example increasing the level of the mechanical ventilation where present."
- Gas appliances and systems must be regularly checked for proper functioning. Please arrange for annual maintenance.
- Clean the gas burners regularly. The flames should be blue and burn evenly.
- Good combustion is required in gas appliances. In case of incomplete combustion, carbon monoxide (CO) might develop. Carbon monoxide is a colourless, odourless and very toxic gas, which has a lethal effect even in very small doses.

- Request information about gas emergency telephone numbers and safety measures in case of gas smell from you local gas provider.

What to do when you smell gas

 Risk of explosion and poisoning! Put out all naked flames and do not smoke, strike matches or do anything that could cause ignition.

Do not operate any electric switches (e.g. light switch, TV, computer, cooker or door bell). Do not use a telephone or mobile phone.

1. Turn off all valves on gas appliances and gas meter at the main control valve, unless it's in a confined space or cellar.
2. Open doors and windows.
3. Check all tubes and connections for tightness. If you still smell gas leave the property.
4. Warn the neighbours.
5. Call the fire-brigade. Use a telephone outside the house.

Call the Gas Emergency Services immediately on 0800 111 999

- 5.1 If you have door or gates that are secured by an electric lock, or entry phone, please open these manually.

6. Do not re-enter the property until you are told it is safe to do so.

Intended use

This product is designed for domestic use. Commercial use is not admissible. This product should not be used for warming the plates under the grill,

drying towels, dish cloths etc, by hanging them on the oven door handles.

This product should also not be used for room heating purposes.

The manufacturer shall not be liable for any damage caused by improper use or handling errors.

The oven can be used for defrosting, baking, roasting and grilling food.

Safety for children

- Accessible parts of the appliance will become hot whilst the appliance is in use and until the appliance has cooled, children should be kept away.
- Accessible parts may be hot when the grill is in use. Young children should be kept away.
- Do not store any items above the appliance that children may reach.
- The packaging materials will be dangerous for children. Keep the packaging materials away from children. Please dispose of all parts of the packaging according to environmental standards.
- When the door is open, do **not** load any heavy object on it and do **not** allow children to sit on it. It may overturn or door hinges may get damaged.

Disposal

Disposing of packaging material

Packaging materials are dangerous to children. Keep packaging materials in a safe place out of reach of children. Packaging materials of the product are manufactured from recyclable materials. Dispose of them properly

and sort in accordance with recycled waste instructions. Do not dispose of them with normal domestic waste.

Old equipment



This appliance bears the selective sorting symbol for waste electrical and electronic equipment (WEEE). This means that this appliance must be handled pursuant to European Directive 2002/96/EC in order to be recycled or dismantled to minimize its impact on the environment. For further information, please contact your local or regional authorities.

Electronic appliances not included in the selective sorting process are potentially dangerous for the environment and human health due to the presence of hazardous substances.

Future transportation

-  Do not place other items on the top of the appliance. The appliance must be transported upright.

Store the appliance's original box and transport the appliance in its original carton. Follow the guidance marks that are printed on the carton.

-  Verify the general appearance of your equipment by identifying possible damage during the transportation.

Secure the caps and pan supports with adhesive tape.

To prevent the wire shelf and tray inside the oven from damaging the oven door, place a strip of cardboard onto the inside of the oven door that lines up with the position of the trays. Tape the oven door to the side walls.

If you do not have the original carton

Pack the appliance in bubble wrap or thick cardboard and tape it securely in order to prevent damage during transportation.

3 Installation

Before installation

To ensure that critical air gaps are maintained under the appliance, we recommend that this appliance is mounted on a solid base and that the feet do not sink into any carpet or soft flooring.

The kitchen floor must be able to carry the weight of the appliance plus the additional weight of cookware and bakeware and food.

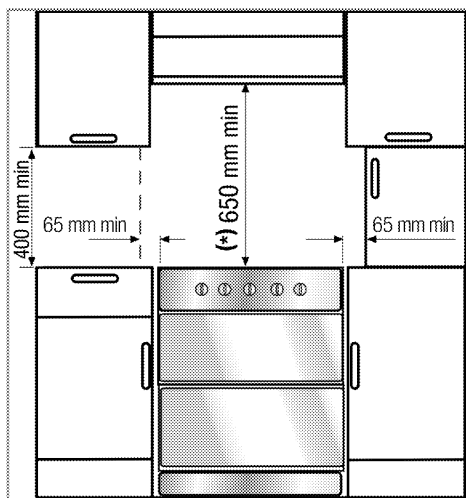

A safety distance must be left between the appliance and the kitchen walls and furniture. See figure (values in mm).

- It can be used with cabinets on either side but in order to have a minimum distance of 400 mm above hotplate level allow a side clearance of 65 mm between the appliance and any wall, partition or tall cupboard.
- It can also be used in a free standing position. Allow a

minimum distance of 650 mm above the hob surface.

- * If a cooker hood is to be installed above the cooker, refer to cooker hood manufacturer's instructions regarding installation height (min 650 mm)
- Movement of your appliance is most easily achieved by lifting the front as follows and pulling towards. Open the top oven door and the bottom oven door sufficiently to allow a comfortable grip on the underside front edge of the oven roofs. While gripping, it should be avoided to damage any grill elements or oven interior furniture.
- The appliance corresponds to device class 1, i.e. it may be placed with the rear and **one** side to kitchen walls, kitchen furniture or equipment of any size. The kitchen furniture or equipment on the **other** side may only be of the same size or smaller.
- Any kitchen furniture next to the appliance must be heat-resistant (100 °C min.).

-  The appliance must be secured against overbalancing by using the supplied safety chain on your oven. Fasten hook (1) to the kitchen wall (5) and connect safety chain (2) to the hook.

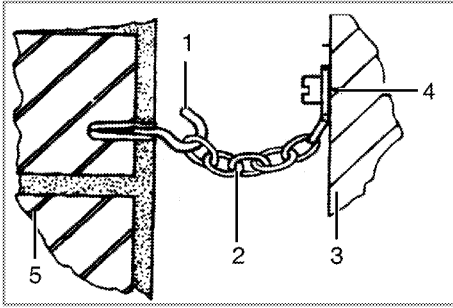

- 1 Hook (is not supplied)
- 2 Safety chain (supplied and mounted to oven)
- 3 Rear of cooker
- 4 Firmly fix chain to cooker rear
- 5 Kitchen wall

Room ventilation

The air for combustion is taken from the room air and the exhaust gases are emitted directly into the room.

Good room ventilation is essential for safe operation of your appliance. If there is no window or door available for room ventilation, an extra ventilation must be installed.

Do not install this appliance in a room below ground level unless it is open to ground level on at least one side.

Failure to install correctly is dangerous and could result in prosecution.

Prolonged intensive use of the appliance may call for additional ventilation, for example the opening of a window, or the use of permanent fixed mechanical ventilation system, for example, an extractor fan or cooker hood that ventilates to the outside.

Room size	Ventilation opening
smaller than 5 m ³	min. 100 cm ²
5 m ³ to 10 m ³	min. 50 cm ²
greater than 10 m ³	not required
In the cellar or basement	min. 65 cm ²

Installation and connection

i Do not install the appliance next to refrigerators or freezers. The heat emitted by the appliance will lead to an increased energy consumption of cooling appliances.

- Appliance to be installed in accordance with the local authority requirements for gas, electricity and any other authority having jurisdiction.
- Carry the appliance with at least two persons.

i **Material damage!**
The door and/or handle must not be used for lifting or moving the appliance.

- The appliance must be placed directly on the floor. It must not be placed onto a base or a pedestal.

Connection to the gas supply

⚠ Risk of explosion or poisoning by unprofessional installation.
The appliance may be connected to the gas distribution system only by an authorized qualified person who is Gas Safe registered.

- ⚠ Risk of explosion!**
Before starting any work on the gas installation, please shut off the gas supply.
- "The adjustment conditions for this appliance are stated on the label (or data plate)."
 - In the UK, Gas Safe registered installers (Including the Regions of British Gas) undertake to work to safe and satisfactory standards.

Regulations

The cooker must be installed in accordance with the Gas Safety (Installation and Use) Regulations and the relevant Building Regulations in force.

- i** Your appliance is adjusted for Natural gas.

The cooker is designed for UK installation using a flexible connection with tubing in accordance with the regulations in force. Length of 900mm is recommend.

Make sure that the natural gas valve is readily accessible.
Service Representative will remove the plug during connection and connect your appliance by means of a straight connection device (coupling).

If a flexible hose is used it must not come into contact with the top 150mm/6 inches (the hot region on the diagram) of the rear of the appliance. Do not pass the hose through the hot region behind the oven.

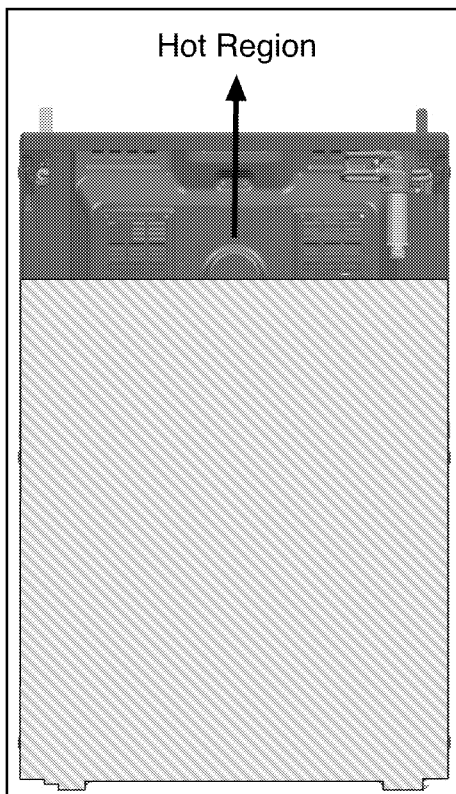

- i** If you need to use your appliance later with a different type of gas, you must consult an authorised service centre for the related conversion procedure.

Connecting the gas hose

Seal all connections with gas sealant.

1. Shut gas supply.
2. Connect cooker hose (5) to the inlet valve of the oven.
3. Connect safety tube with valve with right angled elbow 4.

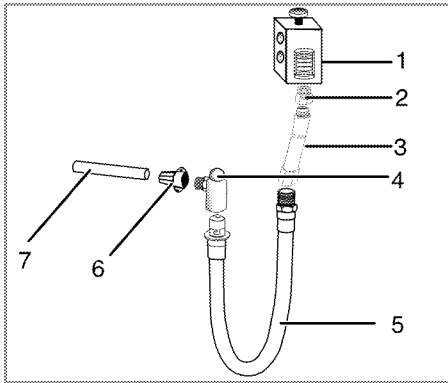

- 1 Shut-off valve
- 2 Adapter (optional) 1/2" outlet
- 3 Extension pipe
- 4 Valve with right angled elbow
- 5 Cooker hose with bayonet fitting
- 6 Connection piece
- 7 Gas feeding tube

⚠ Risk of explosion by damage of the cooker hose!
The cooker hose must not be clamped, bent or trapped or come into contact with hot parts of the appliance.

Connection to the mains supply

ⓘ This appliance must be earthed!

Our company shall not held responsible for any damage caused by using the appliance without earthed socket.

⚠ Risk of electric shock, short circuit or fire by unprofessional installation!
The appliance may be connected to the mains supply only by an authorized qualified person and the appliance is only guaranteed after correct installation.

⚠ Risk of electric shock, short circuit or fire by damage of the mains lead!
The mains lead must not be clamped, bent or trapped or come into contact with hot parts of the appliance.
If the mains lead is damaged, it must be replaced by a qualified electrician.

The mains supply data must correspond to the data specified on the rating plate of the appliance. The rating plate is either seen when the door or the lower cover is opened or it is located at the rear wall of the appliance depending on the appliance type.

The supply cable of the appliance must correspond to the specifications; see technical data table *Technical Data*, page 5.

ⓘ The plug should be easily accessible after installation (but not above the hob).

The moulded plug on this appliance incorporates a 13A fuse. Should the fuse need to be replaced an ASTA approved BS1362 fuse of the same rating must be used. Do not forget to refit the fuse cover. In the event of losing the fuse cover, the plug must not be used until a replacement fuse

cover has been fitted. Colour of the replacement fuse cover must be the same colour as that visible on the pin face of the plug. Fuse covers are available from any good electrical store.

• **Fitting a different plug**

As the colours of the wires in the mains lead of this appliance may not correspond with the coloured markings identifying the terminals on your plug, proceed as follows:

- Brown cable = L (Live)
- Blue cable = N (Neutral)
- Green/yellow cable must be connected to ground (E) $\frac{|||}{\text{—}}$ line. With the alternative plugs a 13A fuse must be fitted either in the plug or adaptor or in the main fuse box. If in doubt contact a qualified electrician.

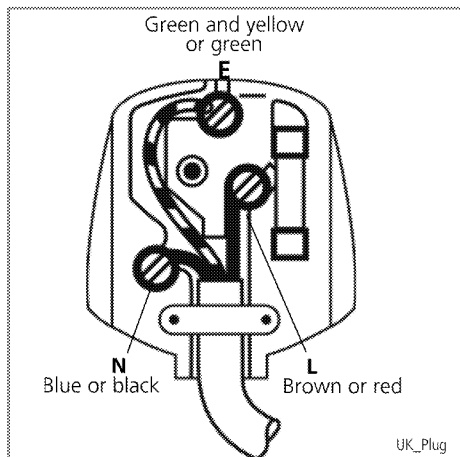

Plug the mains lead into the socket.

- ⚠ Risk of electric shock!
Before starting any work on the electrical installation, please disconnect the appliance from the mains supply.

- Position appliance up to the kitchen wall.
- Securely attach safety chain to the wall behind the cooker.
- To align the appliance with the worktop, adjust the feet turning right or left hand as required.

Final check

1. Check electrical functions.
2. Turn on gas supply.
3. Check gas installations for secure fitting and tightness.
4. Ignite burners and check appearance of the flame.

- ⓘ The flames should be blue and burn smoothly. If the flames appear yellowish, check secure position of the burner cap or clean the burner. Switch off gas and let burner cool before touching it.

Gas conversion

- ⚠ Risk of explosion!
Before starting any work on the gas installation, please shut off the gas supply.

In order to change your appliance's gas type, change all injectors and make flame adjustment for all valves at reduced flow rate position.

- **Gas conversion must only be carried out by a Gas Safe registered installer or service agent.**

Exchange injector for the burners

1. Take off burner cap and burner body.
2. Unscrew injectors.
3. Fit new injectors.

4. Check all connections for secure fitting and tightness.

i New injectors have their position marked on their packing or injector table on *Injector table, page 7* can be referred to.

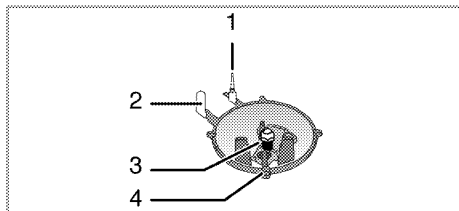

- 1 Flame failure device
- 2 Sparking plug
- 3 Injector
- 4 Burner

i Unless there is an abnormal condition, do not attempt to remove the gas burner taps. You must call an Authorised service agent if it is necessary to change the taps.

Reduced gas flow rate setting for hob taps

1. Ignite the burner that is to be adjusted and turn the knob to the reduced position.
2. Remove the knob from the gas tap.
3. Use an appropriately sized screwdriver to adjust the flow rate adjustment screw.

For LPG (Butane - Propane) turn the screw clockwise.

For the natural gas, you should turn the screw **counter-clockwise** once.

» The normal length of a straight flame in the reduced position should be 6-7 mm.

4. If the flame is higher than the desired position, turn the screw

clockwise. If it is smaller turn anticlockwise.

5. For the last control, bring the burner both to high-flame and reduced positions and check whether the flame is on or off.

Depending on the type of gas tap used in your appliance the adjustment screw position may vary.

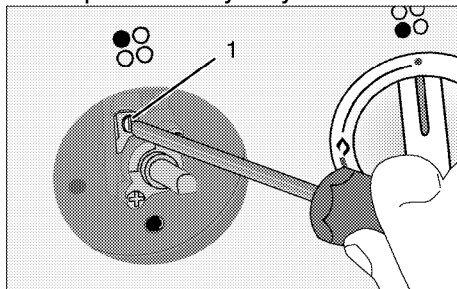

1 Flow rate adjustment screw

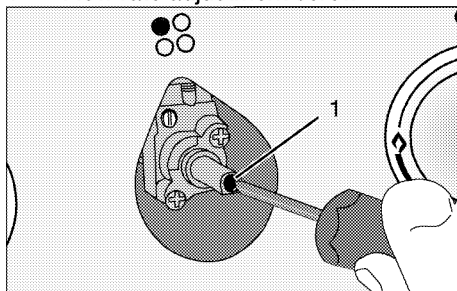

1 Flow rate adjustment screw

Exchange of injector for grill burner

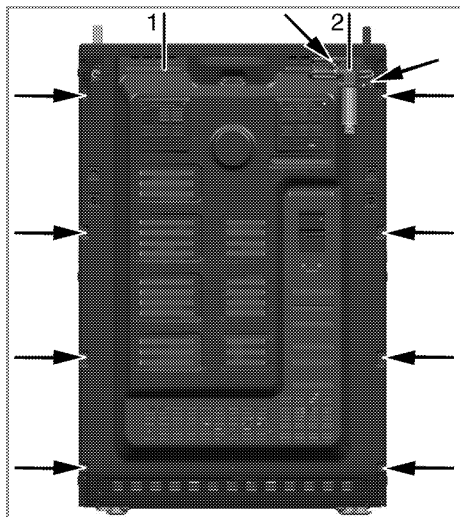

1. Back wall
2. Shut-off valve

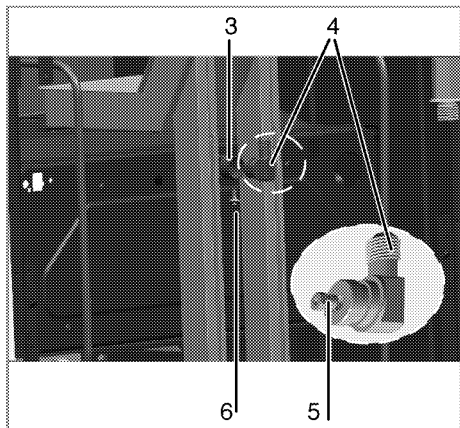

3. Grill burner
4. Injector holder
5. Injector
6. Screw

1- Unscrew the screws fixing the rear cover sheet (1) and shut-off valve holder (2).

2- After removing the rear cover sheet (1), you can reach the grill burner tube (3) and grill injector holder (4).

3- Unscrew the grill injector holder(4) fixing screw(6).

4- Unscrew the injector (5) and replace it with appropriate injector, see injector table, on page 7.

5 - Conduct leakage control after replacing the injector.

6 - Assemble the injector holder (4) into the grill burner tube (3).

7- Fix the injector holder by the screw (6).

8- Assemble the rear cover sheet (1) and shut-off valve holder (2).

Exchange of injector for oven burner

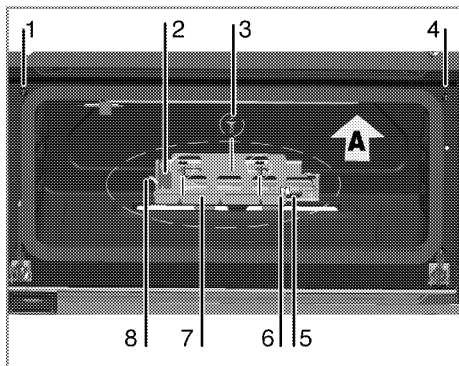

- 1- Door switch
- 2- Oven burner
- 3- Screw (3 pieces)
- 4- Cut-off valve
- 5- Injector holder
- 6- Injector
- 7- Oven burner holder
- 8- Clips

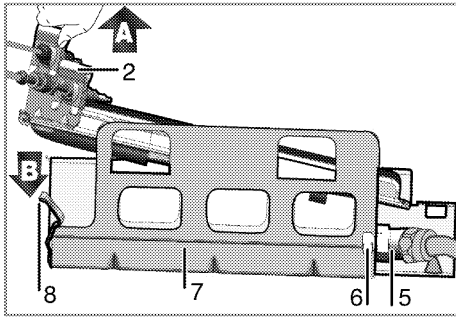

It is recommended to remove the top oven door (see, disassemble oven door on page 35), to provide an ergonomic disassemble of the oven burner.

1- Unscrew 3 screws (3) to remove oven burner (2) and oven burner holder (7).

2- Gently pull up burner and holder in "A" direction- be careful with gas connection tube and thermocouple.

3- Push the clips (8) in "B" direction to disassemble oven burner (2) and its holder(7).

4- Unscrew the injector (6) and replace it with appropriate injector, see injector table, on page 7.

5- Conduct the leakage control after replacing the injector.

6- Assemble the oven burner (2) to its holder (7) by pushing the burner on the clips (8) in "B" direction.

7- Mount the oven burner (2) and holder (7) as a group to the cavity by screwing 3 screws (3).

Reduced flow adjustment for the gas oven

Reduced flow rate adjustment is extremely important for the appropriate functioning of the oven. In order to provide maximum security to the user these operations have to be done with care.

1. Ignite the burner that is to be adjusted and turn the knob to the high flame position.
2. Close the oven door and wait for 10 to 15 minutes until the oven becomes ready for adjustment.
3. After 15 minutes, adjust the oven to the lowest flame position.
4. Take out the knob.
5. Set the flame length to 2 to 3 mm by means of the screw 2 on the oven tap. Turning in clockwise direction reduces the flame, turning counter-clockwise increases the flame.

i If the temperature of the oven increases excessively, turn off the oven and call the authorised service agent to have oven thermostat repaired.

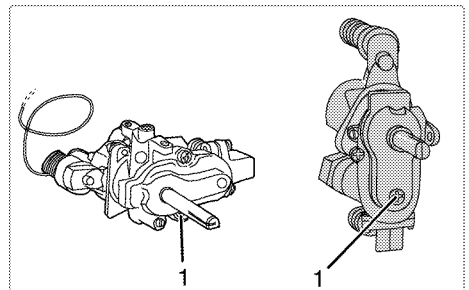

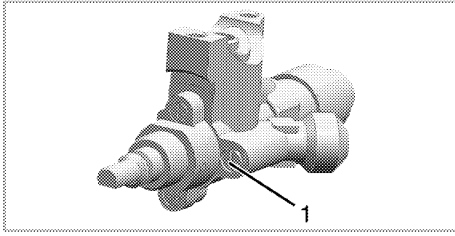

Butan/propan	Natural gas
Fasten the screw until the end	Loosen the screw 1/2 round

- i** If the gas type of the unit is changed, then the rating plate that shows the gas type of the unit must also be changed.

4 Preparation

Tips for saving energy

The following tips will help you to use your appliance in an ecological way and to save energy:



- Use dark coloured and enamel coated trays, since the heat transmission will be better.
- While cooking your meals, perform a preheating operation if it is advised in the user manual or cooking instructions.
- During cooking, do not open the oven door frequently.
- Try to cook more than one type of meal within the oven at the same time (You can cook two different meals at the same time by locating cooking bowls on the same shelf). It will be suitable to cook more than one meal after each other. The oven will already be hot.
- Defrost frozen meals before cooking them.
- Use pots/pans with lids for cooking. Without a lid, the energy consumption may be up to four times higher.
- Choose the burner/plate which is suitable to the saucepan base. Always choose the correct size of saucepans for your meals. For larger burners/plates more energy is needed.

First cleaning of the appliance

-  The surface may get damaged by some detergents or cleaning materials.
Do not use aggressive detergents, cleaning powder/cream or any sharp objects.

1. Remove all packaging materials.
2. Wipe the surfaces of the appliance with a damp cloth or sponge and dry with a cloth.

Initial heating

-  Hot surfaces may cause burns!
Do not touch the hot surfaces of the appliance. Use oven gloves. Keep children away from the appliance...
-  Smell and smoke may emit during first heating. Ensure that the room is well ventilated.

Any production residues or conservation layers must be burnt off before the first use. Heat up the appliance for about 30 minutes and then switch it off.

Gas oven

1. Take all baking trays and wire shelf from the oven.
2. Close oven door.
3. Select largest flame of the gas oven; see *How to use the gas oven*, page 25.
4. Heat approximately 30 minutes.
5. Switch off oven; see *How to use the gas oven*, page 25

5 How to use the hob

General information on cooking

⚠ Risk of fire by overheated oil!
When you heat oil, do not leave it unattended.

Never try to extinguish the fire with water! When oil has caught fire, immediately cover the pot or pan with a lid. Switch off the hob if safe to do so and phone the fire service.

- Ensure handles of pans cannot accidentally be caught or knocked and do not get hot from adjacent heating zones. Avoid pans that are unstable and easily tipped. Pans that are too heavy to move easily when filled can also be a hazard. Only use flat bottomed pots or pans.
- Use pans which have sufficient capacity for the amount of food being cooked so they don't boil over and cause unnecessary cleaning.

Do not place lids on the burners. Always position pans centrally over the burners. When transferring pans from one burner to another always lift the pans do not slide them.

Cooking with gas

- The size of the pan and the size of the gas flame should match each other. Adjust the gas flames so that they do not go beyond the bottom of the pan always place

the pan onto the pan support in a central position.

How to use hobs

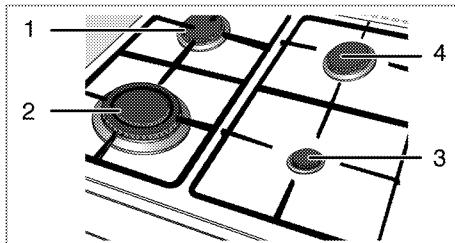

List of advised diameter of pots to be used on related burners.

- 1 Normal burner 18-20 cm
- 2 Rapid burner 22-24 cm
- 3 Auxiliary burner 12-18 cm
- 4 Normal burner 18-20 cm

The large flame symbol corresponds to the highest cooking power, the small flame symbol corresponds to the lowest cooking power. In the off position (top) the gas supply to the burner is turned off.

Ignite the gas burners



The gas burners are ignited by means of the ignition button.

1. Keep hob control knob pressed.
2. Turn anticlockwise to the large flame symbol.
3. Press ignition button and release it again. Repeat the process until the emanating gas is lit.
4. Adjust to the desired cooking power.

Switch off the gas burners

Turn burner control knob to off position (top).

Flame failure device

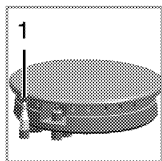

In case of any flame failure for any reasons in the top burners, the flame failure device immediately cuts off the gas flow.

1 . Flame failure device

- Turn the knob clockwise direction by pressing and wait for its ignition.
- Keep the knob at pressed position for 3-5 seconds after you see the flame around the burner.
- Repeat the sequence of operations if the flame does not ignite. After you release the knob, if the ignition does not continue repeat the same process by keeping the knob pressed for 15 seconds.



Risk of deflagration incase of unburned gas!

Do not press the knob for longer than 15 seconds if there was no ignition.

Wait for one minute and then repeat the ignition process.

6 How to operate the oven

General information on baking, roasting and grilling

-  Risk of scalding by hot steam!
Take care when opening the oven door as steam may escape.

Tips for baking

- Select the correct shelf position before turning the oven on – don't move oven shelves when hot.
- Always preheat the oven first for 10 minutes to ensure the food is at the correct temperature as soon as it goes into the oven.
- Use good quality baking tins such as non stick or aluminium. Line tins with greaseproof or baking paper to prevent sticking, if necessary.
- Do not fill cake tin more than half full.
- If baking one tray of food or cake, place centrally on the shelf level and centrally in the oven.
- If cooking on more than one level, swap food between the shelves at least halfway through cooking.
- Try not to open the oven door too much during cooking.
- To check if a cake is cooked, insert a skewer or cocktail stick into the centre. If it comes out clean, the cake is done, if it has food stuck to it, continue to cook the cake for a few minutes more and repeat the process.

Tips for roasting

- Preheat oven first.
- If possible take meat or poultry out of refrigerator 30 minutes before cooking.
- Weigh meat first and calculate how long it will take to cook.

- Before cooking meat or poultry, lightly coat with butter or oil and season with salt, pepper, herbs, or other seasoning. Place in a roasting dish and use a rack to lift the meat out of its juices. Place dish in centre of oven.
- Turn meat over halfway through cooking.
- Remove meat from oven once cooked and stand covered in foil for 10-15 minutes to allow the meat to relax and juices to be reabsorbed which ensures the roast is tender and moist.
- If the roasted meat is covered with foil, (it helps to keep the oven clean), always uncover for the last half an hour of cooking to allow browning.

Tips for grilling

Grilling is a quick and healthy way of cooking meat, fish, vegetables and poultry.

- Preheat grill first.
- To keep the grill pan clean, line with a silicone baking liner. Do not line with aluminium foil.
- Most foods benefit with being brushed with oil before cooking.
- To enhance the flavour and moistness of meat, fish or poultry, marinate first
- If using wooden kebab sticks, soak first to prevent them catching on fire.
- Turn food halfway through cooking to ensure it is evenly browned.

How to use the gas oven

- i** Before using the oven, the clock time must be set. If the clock time is not set, the oven cannot be ignited electrically.

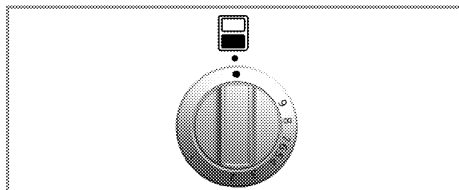

The gas oven is operated by the gas oven control knob. In off position (top) the gas supply is OFF.

Switch on the gas oven

The gas oven is ignited with the ignition button.

1. Open oven door.
2. **Keep** gas oven control knob **pressed** and turn it counterclockwise.
3. Press ignition button and release it again.

- » Repeat the process until the emanating gas is ignited.
4. Keep the gas oven control knob pressed for another 3 to 5 seconds.
 5. Be sure that gas has ignited and flame is present.
 6. If there is no electricity; ignite the gas with the gas lighter from the ignition control hole.
 7. Select the desired gas mark.

⚠ Risk of deflagration by gas that is not ignited!

"The device shall not be operated for more than 15 s. If after 15 s the burner has not lit, stop operating the device and open the compartment door and/or wait at least 1 min before attempting a further ignition of the burner."

Switch off the gas oven

1. Turn gas oven control knob to off position (top).

Gas level temperature conversion chart:

Gas level	1	2	3	4	5	6	7	8	9
Temperature °C	140	145	150	175	190	200	220	240	250
Temperature °F	284	293	302	347	374	392	428	464	482

Cooking times table

- i** The timings in this chart are meant as a guide. Timings may vary due to temperature of food, thickness, type and your own preference of cooking.

- Stand dishes on a baking sheet to prevent spillages onto oven base and help keep oven clean.

Baking and roasting

-Preheat oven first

- i** Level 1 is the **bottom** level in the oven.
- i** Maximum load for the oven tray: 4 kg (8,8 lbs).

Food	Preheating *	Insertion level	Gas mark	Cooking time
Fruit pies	10 min.	4	4	25-30 mins
Pizza	10 min.	4 or 5	4-5	12-25 mins depending on thickness
Small cakes One tray Two trays	10 min.	4 4 and 2	4	20-30 mins
Victoria sandwich	10 min.	4	4	20-30 mins
Biscuits	10 min.	4	4	15-20 mins
Scones	10 min.	4	4	15-20 mins
Rich fruit cake (20-22cm)	10 min.	3	3	3-4 hours??
Roast beef; Sirloin, topside, topump, rib	10 min.	3	7 then 4	20-30 mins, then Rare 15mins per 450g/lb + 15 mins Medium 20mins per 450g/lb + 20mins Well done 25mins per 450g/lb + 25mins
<i>Roast Lamb; Leg, shoulder, rack, breast, whole neck fillet</i>	10 min.	3	7 then 4	20-30 mins, then 20-25mins per 450g/lb + 20 mins
Roast pork; loin, shoulder, leg	10 min.	3	7 then 4	20-30 mins, then 25-30 mins per 450g/lb + 25 mins
Roast chicken	10 min.	3	7 then 4	20 mins, then 20-25 mins per 450g/lb + 20 mins
Roast turkey	–	2	9 then 4...5	20-30 mins, then 25-30 mins per 450g/lb + 25 mins
Casseroles	10 min.	4	3	2-3 hours
Whole fish	10 min.	3	4	20-30 mins
Pasta bake	10 min.	4	5	25-30 mins
* at control knob position 7 / ^s depending on quantity / [#] depending on size				

How to operate the gas grill- Top oven

**⚠ This product is designed for
OPEN DOOR GRILLING.**

**⚠ Hot surfaces may cause burns!
Children must be kept away.
When the door fully open, it
remains tilted slightly, so that
any spillage will be directed
away from you.**

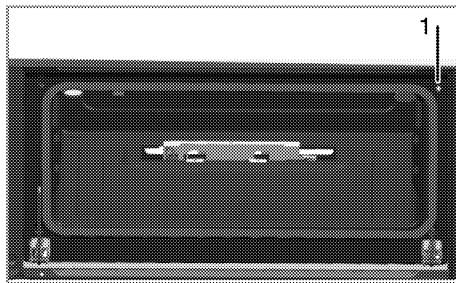

1. Cut-off valve

ⓘ The grill door has a cut-off valve (2). As a safety feature, this valve prevents the grill from working when the door is closed.

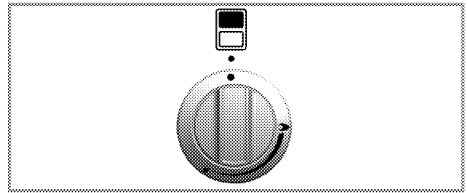

The grill is operated by the grill control knob. In off position (top) the gas supply is locked.

When the door fully open, it remains tilted slightly, so that any spillage will be directed away from you.

Switch on grill

The gas grill is ignited with the ignition button.

1. Open oven door.
2. Keep grill control knob **pressed** and turn it in **counterclockwise** onto the grill symbol.
3. Press ignition button and release it again.
» Repeat the process until the gas is ignited.
4. Keep the grill control knob pressed for another 3 to 5 seconds.
5. Be sure that ignited and flame occurred.
6. If there is no electricity; ignite the gas with the gas lighter direct to grill burner.

⚠ Risk of deflagration by gas that is not ignited!
"The device shall not be operated for more than 15 s. If after 15 s the burner has not lit, stop operating the device and open the compartment door and/or wait at least 1 min before attempting a further ignition of the burner."

Cooking times table

 The timings in this chart are meant as a guide. Timings may vary due to temperature of food, thickness, type and your own preference of cooking.

- If food is cooking too quickly, it can be placed in the bottom of the grill pan.
- Do not place cookware with rough bases on the oven door.
- Ensure that there is at least 25mm space at top of oven when grilling larger foods or cookware.

- Do not place aluminium foil on the wire rack to grill on.
- Turn food over to ensure it is cooked on both sides
- Preheat oven first

 Level 1 is the **bottom** level in the oven.



 Maximum load for the oven tray: 4 kg (8,8 lbs).

Grilling with gas grill

Food	Preparation/setting	Grilling time #
Toast	Place on wire rack in grill pan.	3-5mins
Bacon	Place on wire rack in grill pan.	4-6 mins
Gammon steaks	Place on wire rack in grill pan.	10-15 mins
Beefburgers	Place on wire rack in grill pan.	10-20 mins
Sausages	Place on wire rack in grill pan.	10-15 mins
Chops, chicken pieces	Place on upturned wire rack in grill pan.	15-30 mins
Fish fillets, fish fingers	Place on wire rack in grill pan.	10-20 mins
Grilling /browning tops of foods e.g. cottage pie	Place on base of top oven.	8-10 mins
# depending on size resp. thickness		

7 Maintenance and care

General information

-  Risk of electric shock!
Switch off the electricity before cleaning appliance to avoid an electric shock.
-  Hot surfaces may cause burns!
Allow the appliance to cool down before you clean it.
-  The surface may get damaged by some detergents or cleaning materials.
Do not use aggressive detergents, cleaning powder/cream or any sharp objects.

Clean the appliance thoroughly after each use; in this way it will be possible to remove cooking residues more easily, thus avoiding these from burning the next time the appliance is used.

No special cleaning agents are required for cleaning the appliance. It is recommended to use warm water with washing liquid, a soft cloth or sponge and use a dry cloth for drying.

Do not use any abrasive cleaning materials!

(model dependant) - Do not use any harsh abrasive cleaners, or hard metal scrapers to clean the glass lid as they may scratch the surface. This may destroy the glass.

-  Do not use steam cleaners for cleaning.

How to clean the hob

Gas hobs

1. Remove pan supports and burner caps and clean them.
2. Clean the hob.
3. Refit burner caps and check that they are securely positioned.
4. While placing pan supports, take care that burners are centered to pan supports.

Cleaning the control panel

-  Damage of the control panel!
Do not remove the control knobs for control panel cleaning.

Clean control panel and control knobs.

Cleaning the oven

No oven cleaner or any other special cleaning agent is required for cleaning the oven. It is recommended to wipe the oven with a damp cloth while it is still warm.

Clean oven door

Don't use any harsh abrasive cleaners or sharp metal scrapers for cleaning the oven door. They could scratch the surface and destroy the glass.

Removal of top oven door

1. Open the front door.
2. Open the clips at the hinge housing on the right and left hand sides of the front door by pressing them down as illustrated in the figure.

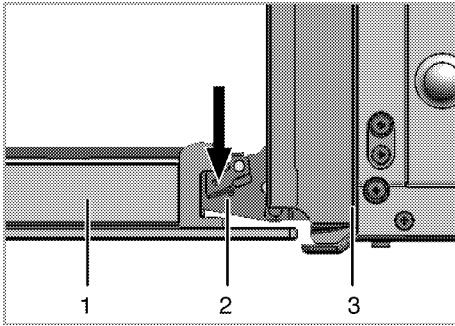

- 1 Front door
- 2 Hinge
- 3 Oven

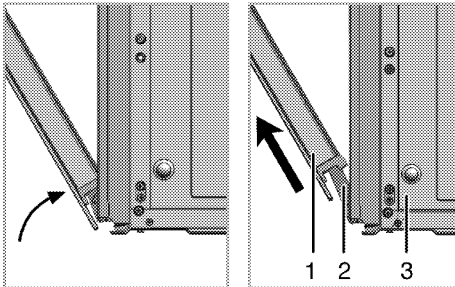

- 3. Move the front door to half-way.
- 4. Remove the front door by pulling it upwards to release it from the right and left hinges.

 Steps carried out during removing process should be performed in reverse order (steps 4, 3, 2 and 1) to reattach the door. Do not forget to close the clips at the hinge housing when reinstalling the door.

Removing the door inner glass

The inner glass panel of the oven door at upper oven can be removed for cleaning.

- Open the oven door.
- Remove the metal part (1) by removing two screws that secure it.

- To remove the plastic holders (2), use a flat metal or plastic, e.g., a knife, slotted screwdriver, to free the fixing foot (5). Push the fixing foot through the window (6) in arrow direction.

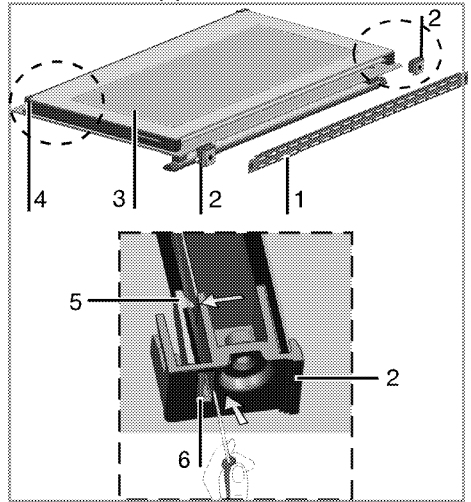

- 1 Metal part
- 2 Plastic carrier
- 3 Inner glass panel
- 4 Lower plastic slot
- 5 Fixing foot
- 6 Window

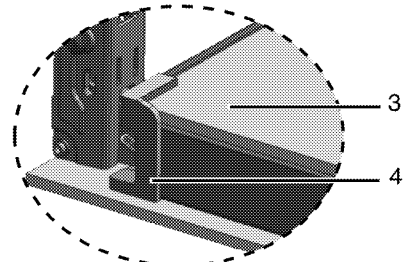

- Pull the inner glass panel (3) towards yourself until it detaches from its plastic slots (4).
- When reinstalling the glass panel, make sure that it is seated into the plastic slots.

Replacing the oven lamp

⚠ Hot surfaces may cause burns! Make sure that the appliance is switched off and cooled down in order to avoid the risk of an electrical shock.

The oven lamp is a special heat-resisting (T 300 °C) electric light bulb; see *Technical Data, page 5*. Oven lamps can be obtained from a good local electrical store.

i Position of lamp may vary from diagram.

1. Switch off the appliance at the mains.
2. Unscrew glass cover by turning anti-clockwise.

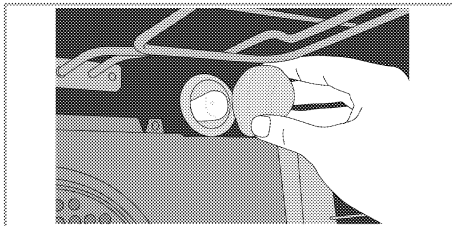

3. Unscrew oven lamp by turning anti-clockwise and replace it with new one.
4. Refit the glass cover.

8 Troubleshooting

 Risk of electric shock, short circuit or fire by unprofessional repairs!
Repairs on the appliance must be carried out by an approved service centre.

 Risk of explosion or poisoning by unprofessional repair.
Repairs on the appliance must be carried out by an approved service centre.

Normal operating conditions

- Smoke and smell may emit for a couple of hours during the first operation.
- It is normal that steam escapes during operation.
- When the metal parts are heated, they may expand and cause noise.

Before you call the service, please check the following points.

Electrical equipment

Malfunction/problem	Possible cause	Advice/remedy
The appliance does not work.	The mains fuse is defective or has tripped.	Check fuses in the fuse box. If necessary, replace or reset them.
	Appliance's plug can not be connected to the grounded socket.	Check the plug connection.
	Timer buttons do not work.	Keylock may be enabled. Please disable it(See;).
Oven light does not work	Oven lamp is defective.	Replace oven lamp.
	No current.	Check fuses in the fuse box. If necessary, replace or reset them.
Oven does not heat.	Function knob and/thermostat knob are not set.	Set function knob and thermostat knob.
	If the appliance has a timer, the timer may not be set.	Set the time.
	No power.	Check mains supply and fuse box.

Gas

Malfunction/problem	Possible cause	Advice/remedy
No ignition spark is produced.	No electric supply to the appliance.	Check fuses in the fuse box.
No gas is emitted.	Main gas tap is closed.	Open gas tap.
	Safety tube is bent.	Install safety tube without bends.
Burners do not burn smoothly or not at all.	Burners are dirty.	Clean burner parts.
	Burners are not dry.	Dry burner parts.
	Burner cap is not securely positioned.	Position burner correctly.
	Gas tap is closed.	Open gas tap.
	Gas container is empty (in case of LPG connection).	Replace gas container.

Clock/ timer (If the appliance has a digital timer)

Malfunction/problem	Possible cause	Advice/remedy
Clock display is blinking or clock symbol is on.	Power was interrupted previously.	Set time Then switch the oven off with function knobs, set the oven function again.

If the problem has not been solved:

1. Separate unit from the mains supply (deactivate or unscrew fuse).
2. Call the appropriate telephone number for your area as shown in the Guarantee and Service section of this user manual.

 Do not attempt to repair the appliance yourself. There are no customer service items inside the appliance.

9 Guarantee and Service

Your Beko product is guaranteed against the cost of breakdown repairs : Freestanding appliances : 1 year
Built-in appliances : 2 year
from the date of the original purchase.

What is covered?

- All repairs necessary as a result of faulty materials, defective components or manufacturing defect.
- The cost of all functional replacement parts.
- The labour costs of a Beko approved repairer to carry out the repair.

What is not covered?

- Transit or delivery damage
- Accidental damage
- Misuse, or abuse.
- Cabinet or appearance parts, including knobs and flaps
- Accessory items, including ice trays, scrapers, cutlery baskets,
- Repairs required as a result of unauthorised repairs or inexpert installation that fails to meet the requirements contained in the user instruction book.

Repairs to products used on commercial or non-residential household premises.

Important notes.

- The product is guaranteed for domestic household use only.
- The guarantee will be void if the product is installed or used in commercial or non-residential household premises.
- The product must be correctly installed, located and operated in accordance with the instructions contained in the User Instructions Booklet provided.
- Professional Installation by a qualified plumber/electrical appliance installer is recommended for all Washing & Dishwashing Machines and Electric Cookers
- Gas Cookers must only be installed by a Gas Safe (or BORD GAIS) registered Gas Installer.
- The guarantee is given only within the boundaries of the United Kingdom.
- The guarantee is not transferable if the product is resold.
- Beko plc disclaims any liability for incidental or consequential damages.
- The guarantee does not in anyway diminish your statutory or legal rights.

HOW TO OBTAIN SERVICE UNDER THE MANUFACTURERS GUARANTEE

Please keep your purchase receipt or other proof of purchase in a safe place; you will need to have it should the product require attention in the guarantee period

You should also complete the details below; it will help us assist you quicker when requesting service. (The model number is printed on the Instruction Booklet)

Model Number: _____ Purchased From: _____ Date of purchase: _____

For service under guarantee simply telephone the appropriate number below

LOCATION

UK Mainland & Northern Ireland

Fridges & Freezers
Electric Cookers
Gas & Dual Fuel Cookers
Washing Machines & Dishwashers

TELEPHONE

0845 600 4903
0845 600 4902
0845 600 4905
0845 600 4906

Republic of Ireland

All Refrigeration, Cooking, Washing & Dishwashing Machines

01 862 3411

Before requesting service please check the trouble-shooting guide in the Operating Instructions as a charge may be levied where no fault is found even though your product may still be under guarantee.

Service once the manufacturers guarantee has expired.

If you have purchased an extended guarantee please refer to the instructions contained within the extended guarantee agreement document. Otherwise please call the above numbers where service can be obtained at a charge.

Should you experience any difficulty in obtaining service please call the

Beko Customer Help-Line on 0845 600 4911

Beko House, Caxton Way, Watford, Herts, WD18 8UF, Tel: 0845 600 4911

24.03.2011-w1

Beko plc
Beko House
Caxton Way
Watford
Herts WD18 8UF
Tel: 0845 600 4911

Printed in Turkey
Part no: 285.3007.09
Rev: AB/ 08.06.2011