

Built-in Oven

User manual

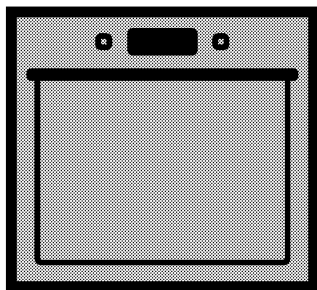

BQM24400BPS

BQM22400XP

EN

285.4455.13/R.AA/08.03.2017

Please read this user manual first!

Dear Customer,

Thank you for purchasing this Beko product. We hope that you get the best results from your product which has been manufactured with high quality and state-of-the-art technology. Therefore, please read this entire user manual and all other accompanying documents carefully before using the product and keep it as a reference for future use. If you handover the product to someone else, give the user manual as well. Follow all warnings and information in the user manual.

Remember that this user manual is also applicable for several other models. Differences between models will be identified in the manual.

Explanation of symbols

Throughout this user manual the following symbols are used:

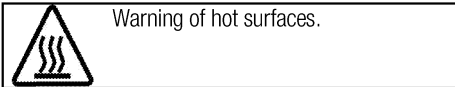
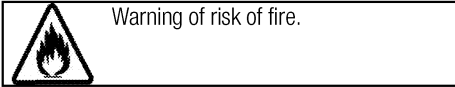
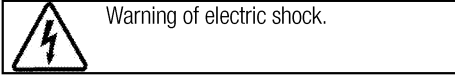
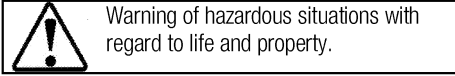
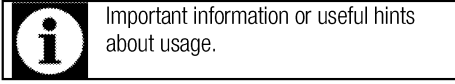

Arçelik A.Ş.

Karaağaç caddesi No:2-6
34445 Sütlüce/İstanbul/TURKEY

Made in TURKEY



This product was manufactured using the latest technology in environmentally friendly conditions.

TABLE OF CONTENTS

1 Important instructions and warnings for safety and environment 4

| | |
|------------------------------------|---|
| General safety | 4 |
| Electrical safety | 4 |
| Product safety | 5 |
| Intended use | 7 |
| Safety for children..... | 8 |
| Disposing of the old product | 8 |
| Package information | 8 |

2 General information 9

| | |
|--------------------------------|----|
| Overview | 9 |
| Package contents | 10 |
| Technical specifications | 11 |

3 Installation 12

| | |
|---|----|
| Before installation | 12 |
| Appliance built-under of the hob and oven configuration..... | 14 |
| Installation and connection | 15 |
| Future Transportation..... | 16 |

4 Preparation 17

| | |
|---------------------------------------|----|
| Tips for saving energy | 17 |
| Initial use..... | 17 |
| Time setting | 17 |
| First cleaning of the appliance | 17 |
| Initial heating..... | 17 |

5 How to operate the oven 19

| | |
|--|----|
| General information on baking, roasting and grilling | 19 |
| How to operate the electric oven | 19 |
| Operating modes..... | 20 |
| How to operate the oven control unit | 22 |
| Cooking times table..... | 26 |
| How to operate the grill..... | 28 |
| Cooking times table for grilling..... | 28 |

6 Maintenance and care 29

| | |
|------------------------------------|----|
| General information..... | 29 |
| Cleaning the control panel | 29 |
| Cleaning the oven | 29 |
| Removing the oven door | 30 |
| Removing the door inner glass..... | 30 |
| Replacing the oven lamp..... | 32 |

7 Troubleshooting 33

8 Guarantee Details 34

1 Important instructions and warnings for safety and environment

This section contains safety instructions that will help protect from risk of personal injury or property damage. Failure to follow these instructions shall void any warranty.

General safety

- This appliance can be used by children aged from 8 years and above and persons with reduced physical, sensory or mental capabilities or lack of experience and knowledge if they have been given supervision or instruction concerning use of the appliance in a safe way and understand the hazards involved.

Children shall not play with the appliance. Cleaning and user maintenance shall not be made by children without supervision.

- The appliance is not to be used by persons (including children) with reduced physical, sensory or mental capabilities, or lack of experience and knowledge, unless they have been given supervision or instruction. Children being supervised not to play with the appliance.
- If the product is handed over to someone else for personal use or second-hand use purposes, the user manual, product labels and

other relevant documents and parts should be also given.

- Installation and repair procedures must always be performed by Authorized Service Agents. The manufacturer shall not be held responsible for damages arising from procedures carried out by unauthorized persons which may also void the warranty. Before installation, read the instructions carefully.
- Do not operate the product if it is defective or has any visible damage.
- Ensure that the product function knobs are switched off after every use.

Electrical safety

- If the product has a failure, it should not be operated unless it is repaired by an Authorized Service Agent. There is the risk of electric shock!
- Only connect the product to a grounded outlet/line with the voltage and protection as specified in the "Technical specifications". Have the grounding installation made by a qualified electrician while using the product with or without a transformer. Our company shall

not be liable for any problems arising due to the product not being earthed in accordance with the local regulations.

- Never wash the product by spreading or pouring water onto it! There is the risk of electric shock!
- The product must be disconnected during installation, maintenance, cleaning and repairing procedures.
- If the power connection cable for the product is damaged, it must be replaced by the manufacturer, its service agent or similarly qualified persons in order to avoid a hazard.
- Only use the connection cable specified in the “Technical specifications”.
- The appliance must be installed so that it can be completely disconnected from the mains supply. The separation must be provided by a switch built into the fixed electrical installation, according to construction regulations.
- Rear surface of the oven gets hot when it is in use. Make sure that the electrical connection does not contact the rear surface; otherwise, connections can get damaged.
- Do not trap the mains cable between the oven door and frame

and do not route it over hot surfaces. Otherwise, cable insulation may melt and cause fire as a result of short circuit.

- Any work on electrical equipment and systems should only be carried out by authorized and qualified persons.
- In case of any damage, switch off the product and disconnect it from the mains. To do this, turn off the fuse at home.
- Make sure that fuse rating is compatible with the product.

Product safety

- **WARNING:** The appliance and its accessible parts become hot during use. Care should be taken to avoid touching heating elements. Children less than 8 years of age shall be kept away unless continuously supervised.
- Never use the product when your judgment or coordination is impaired by the use of alcohol and/or drugs.
- Be careful when using alcoholic drinks in your dishes. Alcohol evaporates at high temperatures and may cause fire since it can ignite when it comes into contact with hot surfaces.
- **Food Poisoning Hazard:** Do not let food sit in oven for more than 1 hour before or after cooking.

Doing so can result in food poisoning or sickness.

- Do not place any flammable materials close to the product as the sides may become hot during use.
- During use the appliances becomes hot. Care should be taken to avoid touching heating elements inside the oven.
- Keep all ventilation slots clear of obstructions.
- Do not heat closed tins and glass jars in the oven. The pressure that would build-up in the tin/jar may cause it to burst.
- Do not place baking trays, dishes or aluminium foil directly onto the bottom of the oven. The heat accumulation might damage the bottom of the oven.
- Do not use harsh abrasive cleaners or sharp metal scrapers to clean the oven door glass since they can scratch the surface, which may result in shattering of the glass.
- Do not use steam cleaners to clean the appliance as this may cause an electric shock.
- (Varies depending on the product model.)

Placing the wire shelf and tray onto the wire racks properly
It is important to place the wire shelf and/or tray onto the rack

properly. Slide the wire shelf or tray between 2 rails and make sure that it is balanced before placing food on it (Please see the following figure).

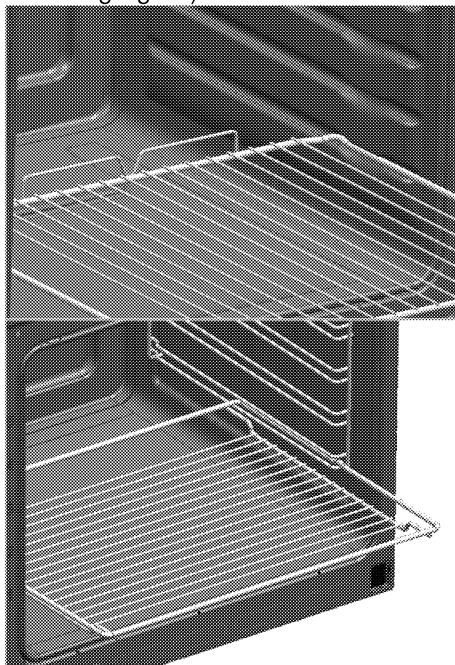

- Do not use the product if the front door glass removed or cracked.
- Do not use the oven handle to hang towels for drying. Do not hang up towel, gloves, or similar textile products when the grill function is at open door.
- Always use heat resistant oven gloves when putting in or removing dishes into/from the hot oven.
- Place the baking paper into the cooking pot or on to the oven accessory (tray, wire grill etc)

together with the food and then insert all into the preheated oven. Remove the excess parts of the baking paper overflowing from the accessory or the pot in order to prevent the risk of touching the oven's heating elements. Never use the baking paper in an operating temperature higher than the indicated value for the baking paper. Do not place the baking paper directly on the base of the oven.

- **WARNING:** Ensure that the appliance is switched off before replacing the lamp to avoid the possibility of electric shock.
- Before the cleaning cycle, remove dirt from exterior surfaces and oven interior with a damp cloth. Remove all accessories inside of oven.
- Hot surfaces cause burns! Do not touch the product during self-cleaning step and keep children away from it. Keep at least 30 minutes before removing the remnants.
- During pyrolytic cleaning, surfaces may become hotter than with standard use. Keep children away.
- The appliance must not be installed behind a decorative door in order to avoid overheating.

- Product must be placed directly on the floor. It must not be placed onto a base or a pedestal.

Prevention against possible fire risk!

- Ensure all electrical connections are secure and tight to prevent risk of arcing.
- Do not use damaged cables or extension cables.
- Ensure liquid or moisture is not accessible to the electrical connection point.

Intended use

- This product is designed for domestic use. Commercial use will void the guarantee.
- This appliance is for cooking purposes only. It must not be used for other purposes, for example room heating.
- This product should not be used for warming the plates under the grill, drying towels, dish cloths etc. by hanging them on the oven door handles. This product should also not be used for room heating purposes.
- The manufacturer shall not be liable for any damage caused by improper use or handling errors.
- The oven can be used for defrosting, baking, roasting and grilling food.

Safety for children

- **WARNING:** Accessible parts may become hot during use. Young children should be kept away.
- The packaging materials will be dangerous for children. Keep the packaging materials away from children. Please dispose of all parts of the packaging according to environmental standards.
- Electrical products are dangerous to children. Keep children away from the product when it is operating and do not allow them to play with the product.
- Do not place any items above the appliance that children may reach for.
- When the door is open, do not load any heavy object on it and do not allow children to sit on it. It may overturn or door hinges may get damaged.

Disposing of the old product

Compliance with the WEEE Directive and Disposing of the Waste Product:



This product complies with EU WEEE Directive (2012/19/EU). This product bears a classification symbol for waste electrical and electronic equipment (WEEE).

This product has been manufactured with high quality parts and materials which can be reused and are suitable for recycling. Do not dispose of the waste product with normal domestic and other wastes at the end of its service life. Take it to the collection center for the recycling of electrical and electronic equipment. Please consult your local authorities to learn about these collection centers.

Compliance with RoHS Directive:

The product you have purchased complies with EU RoHS Directive (2011/65/EU). It does not contain harmful and prohibited materials specified in the Directive.

Package information

- Packaging materials of the product are manufactured from recyclable materials in accordance with our National Environment Regulations. Do not dispose of the packaging materials together with the domestic or other wastes. Take them to the packaging material collection points designated by the local authorities.

2 General information

Overview

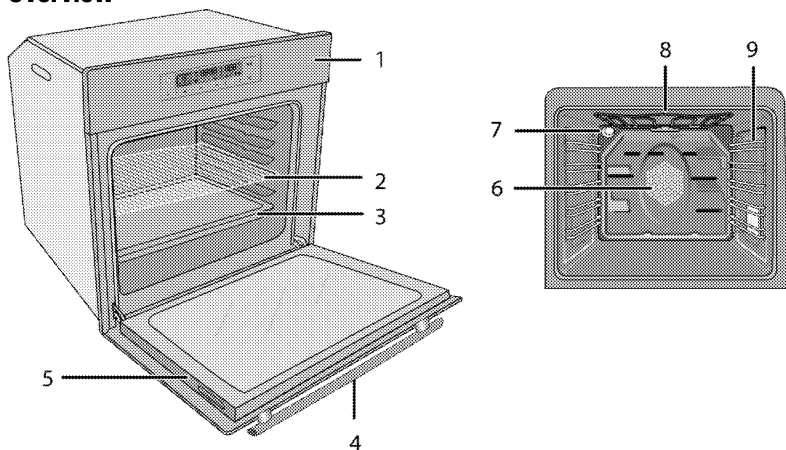

- | | | | |
|---|---------------|---|--------------------------------|
| 1 | Control panel | 6 | Fan motor (behind steel plate) |
| 2 | Wire shelf | 7 | Lamp |
| 3 | Tray | 8 | Top heating element |
| 4 | Handle | 9 | Shelf positions |
| 5 | Door | | |

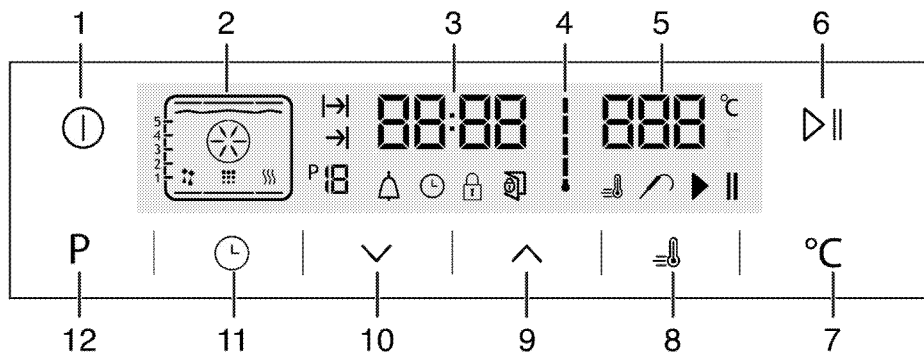

- | | | | |
|---|-------------------------------|----|------------------------------------|
| 1 | ON/OFF key | 7 | Temperature setting key |
| 2 | Function display | 8 | Booster symbol (rapid pre-heating) |
| 3 | Current time indicator field | 9 | Plus key |
| 4 | Oven Inner Temperature symbol | 10 | Minus key |
| 5 | Temperature indicator field | 11 | Adjustment key |
| 6 | Start/stop cooking key | 12 | Return Key to function display |

Package contents



Accessories supplied can vary depending on the product model. Not every accessory described in the user manual may exist on your product.

1. **User manual**

2. **Oven tray**

Used for pastries, frozen foods and big roasts.

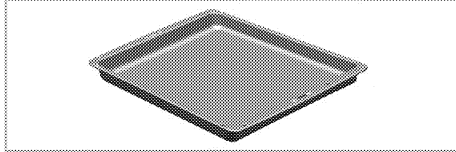

3. **Deep tray**

Used for pastries, large roasts, juicy dishes, and for collecting the fat while grilling.

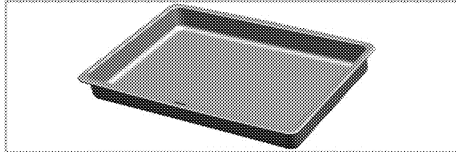

4. **Wire Shelf**

Used for roasting and for placing the food to be baked, roasted or cooked in casserole dishes to the desired rack.

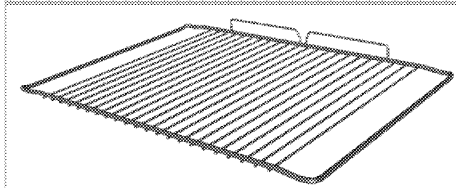
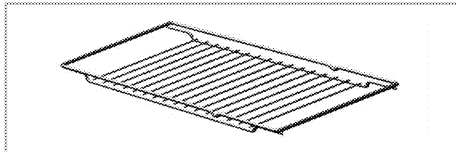

5. **Small wire shelf**

It is placed into the tray (if supplied) in order to collect the dripping fat while grilling so that the oven is kept clean.

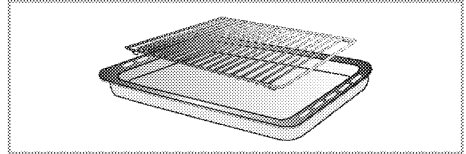

6. **Placing the wire shelf and tray onto the telescopic racks properly (This feature is optional. It may not exist on your product.)**

Telescopic racks allow you to install and remove the trays and wire shelf easily.

When using the tray and wire shelf with telescopic racks, make sure that the pins at the rear section of the telescopic rack stands against the edges of the wire shelf and tray.

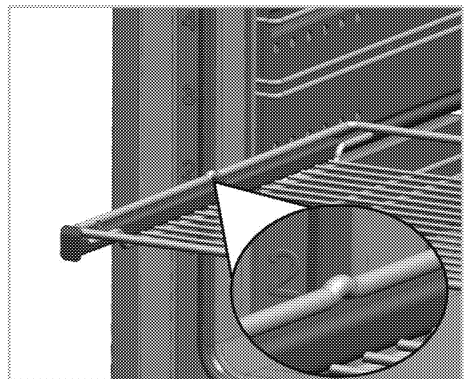
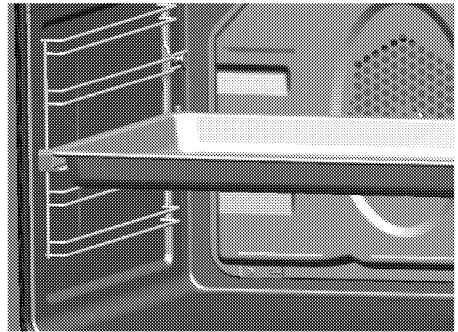



Technical specifications

| | |
|---|--|
| Voltage / frequency | 220-240 V ~ 50 Hz |
| Total power consumption | 3.1 kW |
| Fuse | min. 16 A |
| Cable type / section | min.H05W-FG 3 x 1,5 mm ² or equivalent |
| External dimensions (height / width / depth) | 595 mm/594 mm/567 mm |
| Installation dimensions (height / width / depth) | **590 or 600 mm/560 mm/min. 550 mm |
| Main oven | Multifunction oven |
| Inner lamp | 15/25 W |
| Grill power consumption | 2.2 kW |

Basics: Information on the energy label of electrical ovens is given in accordance with the EN 60350-1 / IEC 60350-1 standard. Those values are determined under standard load with bottom-top heater or fan assisted heating (if any) functions.
Energy efficiency class is determined in accordance with the following prioritization depending on whether the relevant functions exist on the product or not. 1-Cooking with eco-fan, 2- Turbo slow cooking, 3- Turbo cooking, 4- Fan assisted bottom/top heating, 5-Top and bottom heating.

** See. *Installation*, page 12.

| | |
|--|---|
|  | Technical specifications may be changed without prior notice to improve the quality of the product. |
|  | Figures in this manual are schematic and may not exactly match your product. |

| | |
|---|---|
|  | Values stated on the product labels or in the documentation accompanying it are obtained in laboratory conditions in accordance with relevant standards. Depending on operational and environmental conditions of the product, these values may vary. |
|---|---|

3 Installation

Product must be installed by a qualified person in accordance with the regulations in force. The manufacturer shall not be held responsible for damages arising from procedures carried out by unauthorized persons which may also void the warranty.



Preparation of location and electrical installation for the product is under the installer's responsibility.



DANGER:

The product must be installed in accordance with all local electrical regulations.



DANGER:

Prior to installation, visually check if the product has any defects on it. If so, do not have it installed.

Damaged products cause risks for your safety.

Before installation

The appliances must not be installed behind a decorative door in order to avoid overheating. The appliance is intended for installation in commercially available kitchen cabinets. A safety

distance must be left between the appliance and the kitchen walls and furniture. See figure (values in mm).

- Surfaces, synthetic laminates and adhesives used must be heat resistant (100 °C minimum).
- Kitchen cabinets must be set level and fixed.
- If there is a drawer beneath the oven, a shelf must be installed between oven and drawer.
- Carry the appliance with at least two persons.
- The following installation drawings are representational and may not match exactly with your appliance.



Do not install the appliance next to refrigerators or freezers. The heat emitted by the appliance will lead to an increased energy consumption of cooling appliances.



The door and/or handle must not be used for lifting or moving the appliance.



If the appliance has wire handles, push the handles back into the side walls after moving the appliance.

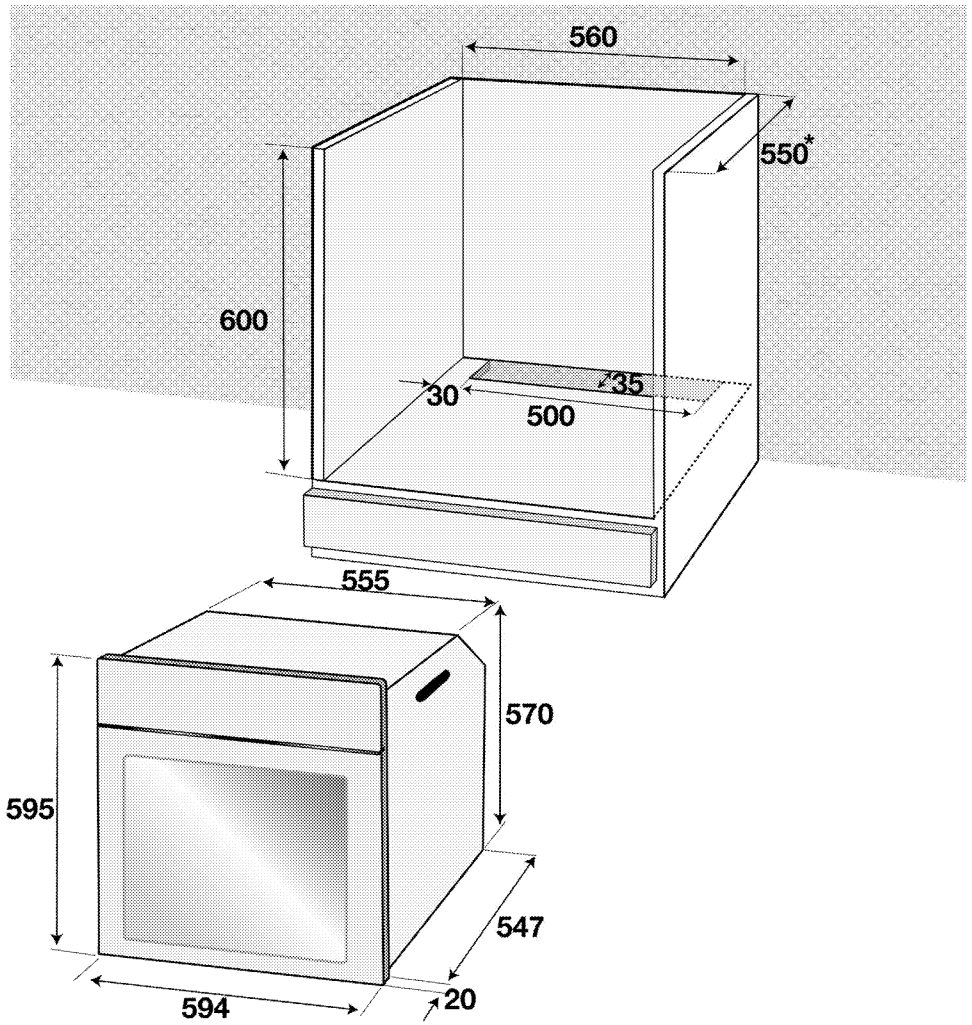

* min.

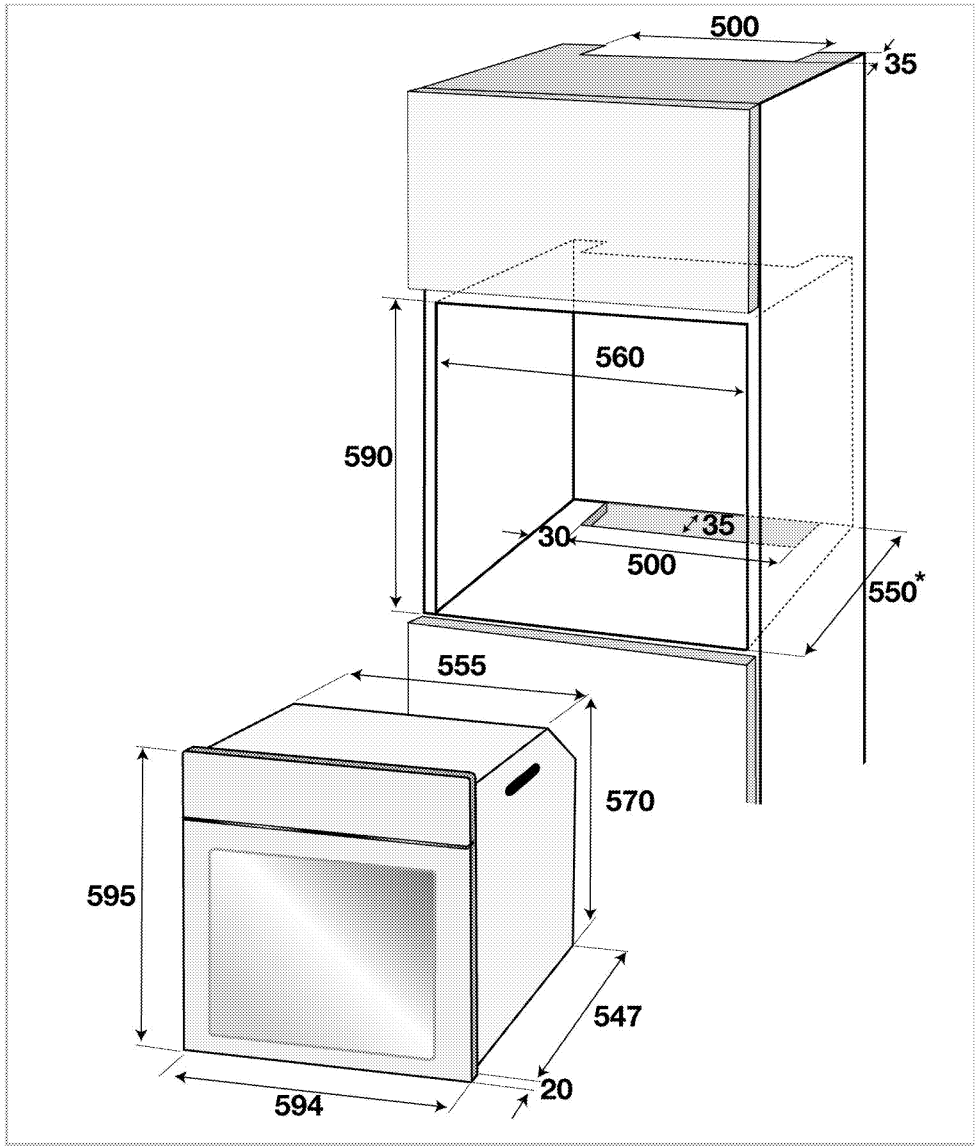

* min.

Appliance built-under of the hob and oven configuration

| Description of hob | 65 - 77 LT | | | 80 - 82 LT | |
|----------------------------------|---------------|---------------|---------------|---------------|---------------|
| | 30 mm Counter | 40 mm Counter | 50 mm Counter | 40 mm Counter | 50 mm Counter |
| 30 cm Induction Hob | ✓ | ✓ | ✓ | ✓ | ✓ |
| 60 cm Side Control Metal Gas Hob | ✓ | ✓ | ✓ | ✓ | ✓ |
| 30 cm Gas Hob (1 Wok) | ✓ | ✓ | ✓ | - | ✓ |
| 30 cm Gas Hob (2 Gas) | - | ✓ | ✓ | - | ✓ |

| | | | | | |
|--|---|---|---|---|---|
| 90 cm Induction Hob with TFT Display | - | ✓ | ✓ | - | - |
| 80 cm Induction Hob | - | ✓ | ✓ | - | ✓ |
| 80 cm Vitroceramic Hob with Touch slider control | ✓ | ✓ | ✓ | - | ✓ |
| 70 cm Metal Gas Hob | ✓ | ✓ | ✓ | - | ✓ |
| 70 cm Front Control Gas on Glass Hob | ✓ | ✓ | ✓ | - | ✓ |
| 3 Wok Hob Burner Configuration | ✓ | ✓ | ✓ | ✓ | ✓ |
| 60 cm Front Control Gas on Glass Hob | ✓ | ✓ | ✓ | - | ✓ |
| 60 cm Front Control Metal Gas Hob | ✓ | ✓ | ✓ | - | ✓ |
| 60 cm Front Control Flat Metal Gas Hob | ✓ | ✓ | ✓ | - | ✓ |
| 70 cm Front Control Flat Metal Gas Hob | ✓ | ✓ | ✓ | - | ✓ |
| 30 cm Vitroceramic Hob | ✓ | ✓ | ✓ | ✓ | ✓ |
| 60 cm Induction Hob with Touch slider control | - | ✓ | ✓ | - | ✓ |
| 60 cm Induction Hob with 8 induction zones | - | ✓ | ✓ | - | - |
| 60 cm Induction Hob with Basic Touch control | - | ✓ | ✓ | - | ✓ |
| 80 cm Induction Hob with Touch slider control | - | ✓ | ✓ | - | ✓ |
| 60 cm Vitroceramic Hob with Touch slider control | ✓ | ✓ | ✓ | - | ✓ |
| 60 cm Vitroceramic Hob with Basic Touch control | ✓ | ✓ | ✓ | ✓ | ✓ |
| 80 cm Vitroceramic Hob with Touch slider control | ✓ | ✓ | ✓ | - | ✓ |

Installation and connection

- The product must be installed in accordance with all local gas and electrical regulations.

Electrical connection

Connect the product to a grounded outlet/line protected by a fuse of suitable capacity as stated in the "Technical specifications" table. Have the grounding installation made by a qualified electrician while using the product with or without a transformer. Our company shall not be liable for any damages that will arise due to using the product without a grounding installation in accordance with the local regulations.



DANGER:
The product must be connected to the mains supply only by an authorised and qualified person.
Manufacturer shall not be held responsible for damages arising from procedures carried out by unauthorised persons.



DANGER:
The power cable must not be clamped, bent or trapped or come into contact with hot parts of the product.
A damaged power cable must be replaced by a qualified electrician. Otherwise, there is risk of electric shock, short circuit or fire!

- Connection must comply with national regulations.
- The mains supply data must correspond to the data specified on the type label of the product. Open the front door to see the type label.

- Power cable of your product must comply with the values in "Technical specifications" table.



DANGER:
Before starting any work on the electrical installation, disconnect the product from the mains supply.
There is the risk of electric shock!

Connecting the power cable

- If a power cable is not supplied together with your product, a power cable that you would select from the table in accordance with the electrical installation at your home must be connected to your product by following the instructions in cable diagram.

This product must only be connected by a qualified electrician such as a technician from the local electricity company or NICEIC registered contractor to a suitable double-pole control unit with a minimum contact clearance of 3 mm in all poles. This control unit must be installed accordance with the IEE regulation. Failure to obey this instruction may cause operational problems and invalidate the product warranty.



Additional protection by a residual current circuit breaker is recommended.

- Open the terminal block cover with a screwdriver.
- Insert the power cable through the cable clamp below the terminal and secure it to the main body with the integrated screw on cable clamping component.

- Connect the cables according to the supplied diagram.

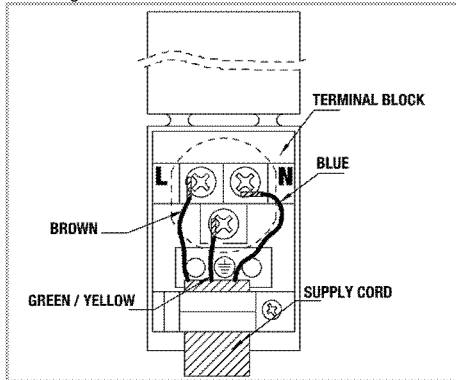

- After completing the wire connections, close the terminal block cover.
- Route the power cable so that it will not contact the product and get squeezed between the product and the wall.

i Power cable must not be longer than 2 m because of safety reasons.

Installing the product

- Slide the oven into the cabinet, align and secure it while making sure that the power cable is not broken and/or trapped.

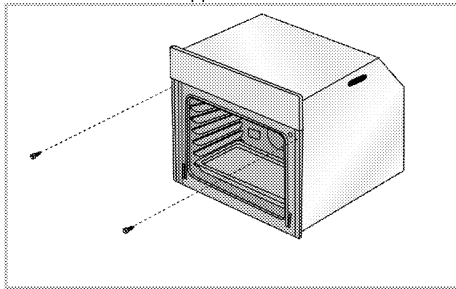

Secure the oven with 2 screws as illustrated.

For products with cooling fan (It may not exist on your product.)

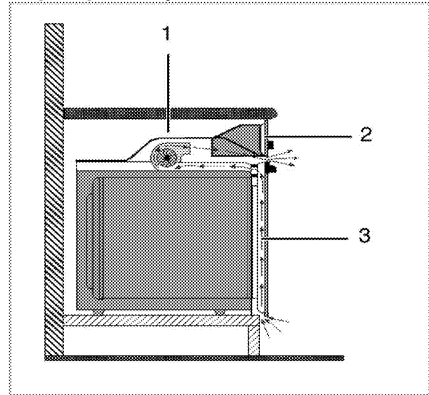

- Cooling fan
- Control panel
- Door

The built-in cooling fan cools both the built-in cabinet and the front of the product.

i Cooling fan continues to operate for about 20-30 minutes after the oven is switched off. If you have cooked by programming the timer of the oven, cooling fan will also be switched off at the end of the cooking time together with all functions.

Final check

- Connect the power cable and switch on the product's fuse.
- Check the functions.

Future Transportation

- Keep the product's original carton and transport the product in it. Follow the instructions on the carton. If you do not have the original carton, pack the product in bubble wrap or thick cardboard and tape it securely.
- To prevent the wire grill and tray inside the oven from damaging the oven door, place a strip of cardboard onto the inside of the oven door that lines up with the position of the trays. Tape the oven door to the side walls.
- Do not use the door or handle to lift or move the product.

i Do not place any objects onto the product and move it in upright position.

i Check the general appearance of your product for any damages that might have occurred during transportation.

4 Preparation

Tips for saving energy

The following information will help you to use your appliance in an ecological way, and to save energy:

- Use dark coloured or enamel coated cookware in the oven since the heat transmission will be better.
- While cooking your dishes, perform a preheating operation if it is advised in the user manual or cooking instructions.
- Do not open the door of the oven frequently during cooking.

- Try to cook more than one dish in the oven at the same time whenever possible. You can cook by placing two cooking vessels onto the wire shelf.
- Cook more than one dish one after another. The oven will already be hot.
- You can save energy by switching off your oven a few minutes before the end of the cooking time. Do not open the oven door.
- Defrost frozen dishes before cooking them.

Initial use

Time setting

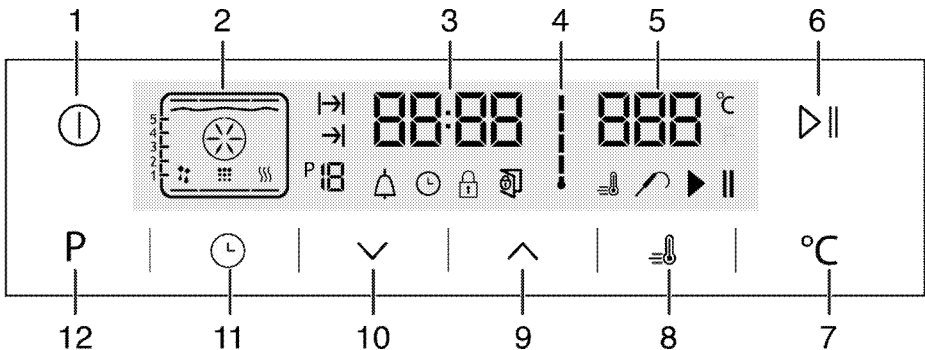

- 1 ON/OFF key
- 2 Function display
- 3 Current time indicator field
- 4 Oven Inner Temperature symbol
- 5 Temperature indicator field
- 6 Start/stop cooking key
- 7 Temperature setting key
- 8 Booster symbol (rapid pre-heating)
- 9 Plus key
- 10 Minus key
- 11 Adjustment key
- 12 Return Key to function display

1. At the initial operation of the oven ⌚ symbol lights up, touch \wedge / \vee keys to set the hour.
2. Confirm the setting by touching ⌚ symbol and wait for 4 seconds without touching any keys to confirm.

i If the current time is not set, time indicator will start increasing/moving up from **12:00**. ⌚ symbol will be activated to indicate that the current time has not been set. It will disappear as soon as the time is set.

First cleaning of the appliance



The surface might get damaged by some detergents or cleaning materials.

Do not use aggressive detergents, cleaning powders/creams or any sharp objects during cleaning.

Do not use harsh abrasive cleaners or sharp metal scrapers to clean the oven door glass since they can scratch the surface, which may result in shattering of the glass.

1. Remove all packaging materials.
2. Wipe the surfaces of the appliance with a damp cloth or sponge and dry with a cloth.

Initial heating

Heat up the product for about 30 minutes and then switch it off. Thus, any production residues or layers will be burnt off and removed.



WARNING

Hot surfaces cause burns!

Product may be hot when it is in use. Never touch the hot burners, inner sections of the oven, heaters and etc. Keep children away. Always use heat resistant oven gloves when putting in or removing dishes into/from the hot oven.

Electric oven

1. Take all baking trays and the wire grill out of the oven.
2. Close the oven door.
3. Select Static position.
4. Select the highest grill power; See *How to operate the electric oven, page 19*.
5. Operate the oven for about 30 minutes.

6. Turn off your oven; See *How to operate the electric oven, page 19*

Grill oven

1. Take all baking trays and the wire grill out of the oven.
2. Close the oven door.
3. Select the highest grill power; see *How to operate the grill, page 28*.
4. Operate the grill about 30 minutes.
5. Turn off your grill; see *How to operate the grill, page 28*



Smoke and smell may emit for a couple of hours during the initial operation. This is quite normal. Ensure that the room is well ventilated to remove the smoke and smell. Avoid directly inhaling the smoke and the smell that emits.

5 How to operate the oven

General information on baking, roasting and grilling



WARNING

Hot surfaces cause burns!
Product may be hot when it is in use. Never touch the hot burners, inner sections of the oven, heaters and etc. Keep children away. Always use heat resistant oven gloves when putting in or removing dishes into/from the hot oven.



DANGER:

Be careful when opening the oven door as steam may escape.
Exiting steam can scald your hands, face and/or eyes.

Tips for baking

- Use non-sticky coated appropriate metal plates or aluminum vessels or heat-resistant silicone moulds.
- Make best use of the space on the rack.
- Place the baking mould in the middle of the shelf.
- Select the correct rack position before turning the oven or grill on. Do not change the rack position when the oven is hot.
- Keep the oven door closed.

Tips for roasting

- Treating whole chicken, turkey and large piece of meat with dressings such as lemon juice and black pepper before cooking will increase the cooking performance.
- It takes about 15 to 30 minutes longer to roast meat with bones when compared to roasting the same size of meat without bones.
- Each centimeter of meat thickness requires approximately 4 to 5 minutes of cooking time.
- Let meat rest in the oven for about 10 minutes after the cooking time is over. The juice is better distributed all over the roast and does not run out when the meat is cut.
- Fish should be placed on the middle or lower rack in a heat-resistant plate.

Tips for grilling

When meat, fish and poultry are grilled, they quickly get brown, have a nice crust and do not get dry. Flat pieces, meat skewers and sausages are particularly suited for grilling as are vegetables with high water content such as tomatoes and onions.

- Distribute the pieces to be grilled on the wire shelf or in the baking tray with wire shelf in such

a way that the space covered does not exceed the size of the heater.

- Slide the wire shelf or baking tray with grill into the desired level in the oven. If you are grilling on the wire shelf, slide the baking tray to the lower rack to collect fats. Add some water in the tray for easy cleaning.



Foods that are not suitable for grilling carry the risk of fire. Only grill food which is suitable for intensive grilling heat.

Do not place the food too far in the back of the grill. This is the hottest area and fatty food may catch fire.

How to operate the electric oven

Rack positions (For models with wire shelf)

It is important to place the wire shelf onto the side rack correctly. Wire shelf must be inserted between the side racks as illustrated in the figure.

Do not let the wire shelf stand against the rear wall of the oven. Slide your wire shelf to the front section of the rack and settle it with the help of the door in order to obtain a good grill performance.

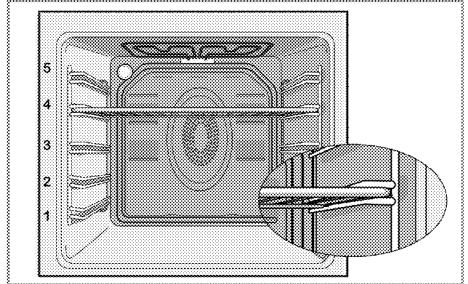

Operating modes

The order of operating modes shown here may be different from the arrangement on your product.

1. Top and bottom heating



Food is heated simultaneously from the top and bottom. For example, it is suitable for cakes, pastries, or cakes and casseroles in baking moulds. Cook with one tray only.

Suitable rack position will be displayed on screen.

2. Fan supported bottom/top heating



Hot air heated by the bottom and top heaters is evenly distributed throughout the oven rapidly by means of the fan. Cook with one tray.

3. Fan Heating

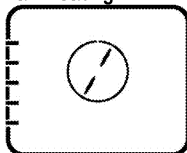

Warm air heated by the rear heater is evenly distributed throughout the oven rapidly by means of the fan. It is suitable for cooking your meals in different rack levels and preheating is not required in most cases. Suitable for cooking with multi trays.

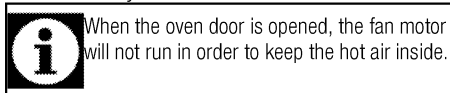

When the oven door is opened, the fan motor will not run in order to keep the hot air inside.

4. "3D" function



Top heating, bottom heating and fan assisted heating are in operation. Food is cooked evenly and quickly all around. Cook with one tray only.

5. Pizza function



The bottom heating and fan assisted heating are in operation. Suitable for baking pizza.

6. Full grill+Fan



Hot air heated by the full grill is distributed very fast in the oven by means of the fan. It is suitable for grilling large amount of meat.

- Put big or medium-sized portions in correct rack position under the grill heater for grilling.
- Set the temperature to maximum level.
- Turn the food after half of the grilling time.

7. Full grill

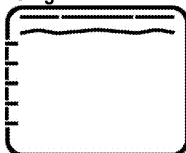

Large grill at the ceiling of the oven is in operation. It is suitable for grilling large amount of meat.

- Put big or medium-sized portions in correct rack position under the grill heater for grilling.
- Set the temperature to maximum level.
- Turn the food after half of the grilling time.

8. Grill

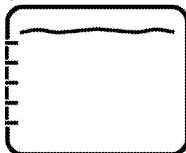

Small grill at the ceiling of the oven is in operation. Suitable for grilling and gratin dishes.

- Put small or medium-sized portions in correct shelf position under the grill heater for grilling.
- Set the temperature to maximum level.
- Turn the food after half of the grilling time.

9. **Slow cooking/Eco Fan Heating**

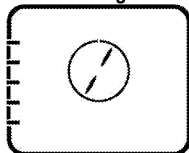

To save power, you can use this function instead of the cooking operations that you would perform by using Fan Heating at 160-220°C temperature range. But, the cooking time will increase a little bit.

Cooking times related to this function are indicated in 'Slow cooking/Eco Fan Heating' table.

10. **Bottom heating**



Only bottom heating is in operation. It is suitable for pizza and for subsequent browning of food from the bottom.

11. **Keep warm**

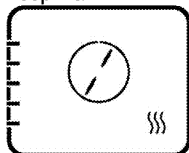

Used for keeping food at a temperature ready for serving for a long period of time.

12. **Operating with fan**

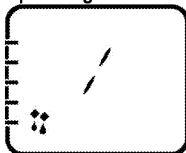

The oven is not heated. Only the fan (in the rear wall) is in operation. Suitable for thawing frozen granular food slowly at room temperature and cooling down the cooked food.

13. **Pyrolysis - economy mode**



This function allows the oven to clean itself at a high temperature. It is recommended for lightly soiled ovens. Read the description in the cleaning section to use this function see, *page 29*.

14. **Pyrolysis**

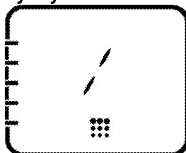

This function allows the oven to clean itself at a high temperature. Read the description in the cleaning section to use this function see, *page 29*.

How to operate the oven control unit

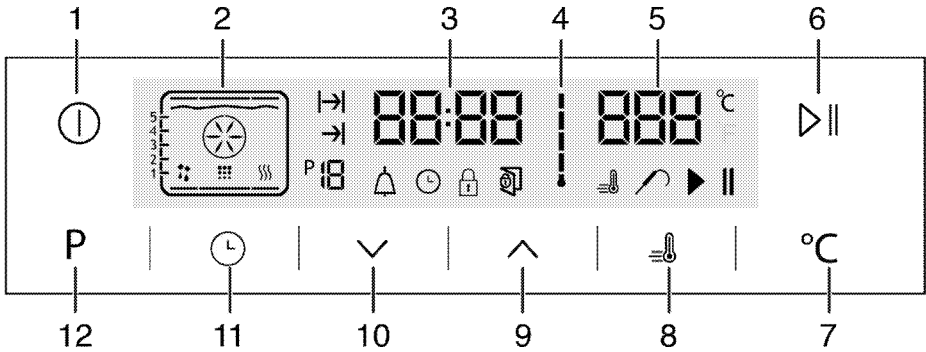

- 1 ON/OFF key
- 2 Function display
- 3 Current time indicator field
- 4 Oven Inner Temperature symbol
- 5 Temperature indicator field
- 6 Start/stop cooking key
- 7 Temperature setting key
- 8 Booster symbol (rapid pre-heating)
- 9 Plus key
- 10 Minus key
- 11 Adjustment key
- 12 Return Key to function display

- : Cooking Time symbol
- : End of Cooking Time symbol
- : Function number
- : Alarm symbol
- : Clock symbol
- : Keylock symbol
- : Open door symbol
- : Booster symbol (rapid pre-heating)
- : Meat Probe symbol
- : Cooking pause symbol
- : Cooking starting symbol

Function table:

Function table indicates the operating functions that can be used in the oven and their respective maximum and minimum temperatures.

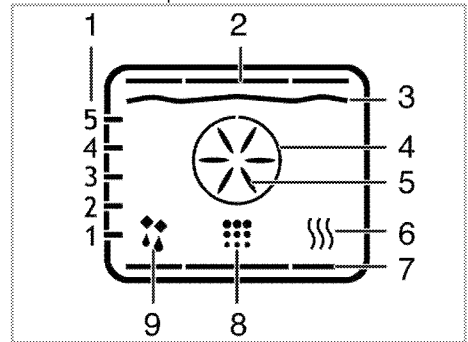





- 1 Shelf positions
- 2 Top heater
- 3 Grill heater
- 4 Boost heater
- 5 Boost fan
- 6 Keep warm
- 7 Bottom heater
- 8 Cleaning position
- 9 Operating with fan position





Functions vary depending on the product model!

| Function table | Recommended temperature (°C) | Temperature range (°C) |
|----------------------------------|------------------------------|------------------------|
| Top and bottom heating | 200 | 40-280 |
| Fan supported bottom/top heating | 175 | 40-280 |
| Fan assisted cooking | 180 | 40-280 |
| **3D** function | 205 | 40-280 |
| Pizza function | 210 | 40-280 |
| Fan assisted large grill | 200 | 40-280 |
| Full grill | 280 | 40-280 |
| Low grill | 280 | 40-280 |
| Eco Fan Heating | 180 | 160-220 |
| Bottom heating | 180 | 40-220 |
| Warm keeping | 60 | 40-100 |

| | |
|---|--|
|  | Maximum adjustable cooking time in modes except warm keeping is limited with 6 hours due to safety reasons. Program will be cancelled in case of power failure. You must reprogram the oven. |
|  | While making any adjustment, related symbols on the clock will flash. |
|  | Current time cannot be set while the oven is operating in any function, or if semi-automatic or full automatic programming is made on the oven. |
|  | Even if the oven is off, oven lamp lights up when the oven door is opened. |











How to operate the oven

1. Touch the  key for approx. 2 seconds to open the oven.
» First operating function appears on display after the oven turns on. When the display is in this mode, cooking time, the end of cooking time and Booster (quick heating) function can be set.

| | |
|--|---|
|  | Oven will switch off automatically within 20 seconds if no oven setting is made on this screen. |
|--|---|









Manual cooking by selecting temperature and operating function







You can do cooking by selecting temperature and operating function specific to your meal, manually controlling without setting the cooking duration.

1. First operating function appears on display after touching  button to open the oven.
2. Select the operating function by touching the  keys.
3. If you desire to change the temperature that is recommended for operating function, enable the temperature field by touching  button.
»  symbol flashes.
4. Set the desired temperature touching  keys.
5. Confirm the temperature setting by touching  key.
6. Put your dish into the oven.
7. Touch  key to start cooking if temperature and operating function are appropriate.  symbol appears on display.
» Your oven will readily start operating in the selected function and will increase the inner temperature to the set temperature. Each grades of the inner temperature symbol will be lit as inner temperature reaches to the set temperature. Additional active heaters and recommended tray position appear in the Function display.
8. The oven does not turn off automatically due to the manual cooking without setting the cooking time. You can finish cooking by touching  key once again.
» The oven finishes the cooking and  symbol appears on display.
9. Touch the  button for approx. 2 seconds to close the oven.

Cooking by setting the cooking time;













You can ensure that the oven turns off by selecting temperature and operating function specific to your meal and setting the cooking time, manually controlling without setting the cooking duration.







1. First operating function appears on display after touching  button to open the oven.
2. Select the operating function by touching the  keys.
3. If you desire to change the temperature that is recommended for operating function, enable the temperature field by touching  button.
»  symbol flashes.
4. Set the desired temperature touching  keys.
5. Confirm the temperature setting by touching  key.
6. Touch  until  symbol appears on display for cooking time.

7. Set the cooking time by touching  keys and confirm the setting by touching  key.
» Once the Cooking Time is set,  symbol will appear on display continuously.
8. Put your dish into the oven.
9. Touch   key to start cooking if temperature, operating function and cooking time are appropriate.  symbol appears on display.
» The oven will be heated up to the set temperature and will maintain this temperature until the end of the cooking time you selected.
» Your oven will readily start operating in the selected function and will increase the inner temperature to the set temperature. It maintains this temperature until the end of the set cooking time. Each grades of the inner temperature symbol will be lit as inner temperature reaches to the set temperature. Additional active heaters and recommended tray position appear in the Function display.
10. After the cooking process is completed, "End" appears on the display and the alarm sounds.
11. Touch any key to silence the alarm.
» Alarm stops and the oven finishes operating automatically.

Setting the the end of cooking time to a later time;

You can ensure that the oven runs and turns off automatically by setting temperature and operating function specific to your meal, the cooking time and end of cooking to a later time, manually controlling without setting the cooking duration.

1. First operating function appears on display after touching  button to open the oven.
2. Select the operating function by touching the  keys.
3. If you desire to change the temperature that is recommended for operating function, enable the temperature field by touching  button.
»  symbol flashes.
4. Set the desired temperature touching  keys.
5. Confirm the temperature setting by touching  key.
6. Touch  until  symbol appears on display for cooking time.
7. Set the cooking time by touching  keys and confirm the setting by touching  key.
» Once the Cooking Time is set,  symbol will appear on display continuously.
8. Touch  until  symbol appears on display for the end of cooking time.

9. Set the cooking time by touching  buttons and confirm the setting by touching  key.
» Once the the end of cooking time is set,  symbol will appear on display continuously.
10. Put your dish into the oven.
11. Touch   key to start cooking if temperature, operating function, cooking time and the end of cooking time are appropriate.  symbol appears on display.
» Oven timer automatically calculates the startup time for cooking by deducting the cooking time from the end of cooking time you have set. Selected operation mode is activated when the startup time of cooking has come and the oven is heated up to the set temperature. It maintains this temperature until the end of the set cooking time. Each grades of the inner temperature symbol will be lit as inner temperature reaches to the set temperature. Additional active heaters and recommended tray position appear in the Function display.
12. After the cooking process is completed, "End" appears on the display and the alarm sounds.
13. Touch any key to silence the alarm.
» Alarm stops and the oven finishes operating automatically.







If you want to cancel only cooking time or cooking time plus the end of cooking time after you have set them, you need to reset the cooking time.

Setting the booster (Quick Pre-heating)

Use Booster (Rapid Pre-heating) function to make the oven reach the desired temperature faster.



Booster cannot be selected in defrosting, eco fan heating ,keeping warm and cleaning positions. Booster settings will be cancelled in case of power outage.





1. Touch  key after setting the temperature, operating function, cooking time and the end of cooking time.
»  symbol appears continuously and booster (rapid pre-heating) setting is enabled.
»  symbol disappears as soon as the oven reaches the desired temperature and oven resumes operating in the function it was in before the Booster function.
2. Touch the  key again in order to cancel booster function.
»  symbol disappears and booster (rapid pre-heating) setting is disabled.

Switching off the electric oven

Touch  key to switch off the oven.

Activating the keylock





You can prevent oven from being intervened with by activating the key lock function.

1. Touch  until  symbol appears on display.
» "OFF" will appear on the display.
2. Press  to activate the key lock.
» Once the key lock is activated, "On" appears on the display and the  symbol remains lit. Confirm by touching .



Oven keys are not functional when the key lock is activated. Key lock will not be cancelled in case of power failure.

To deactivate the keylock,



1. Touch  until  symbol appears on display.
» "On" will appear on the display.
2. Disable the key lock by pressing the  key.
» "OFF" will appear once the key lock is deactivated. Confirm by touching .



Oven keys are not functional when the Key lock function is activated. Key lock settings will not be cancelled in case of power outage.





Setting the alarm clock

You can use the timer of the product for any warning or reminder apart from the cooking program. The alarm clock has no influence on the functions of the oven. It is only used as a warning. For example, this is useful when you want to turn food in the oven at a certain point of time. Timer will give an audio warning at the end of the set time.

1. Touch  until  symbol appears on display.





Maximum alarm time can be 23 hours and 59 minutes.

2. Set the alarm duration by using  /  keys.
»  symbol will remain lit and the alarm time will appear on the display once the alarm time is set.
3. At the end of the alarm time,  symbol starts flashing and the audio warning is heard.

Turning off the alarm

1. Audio warning sounds for 2 minutes. To stop the audio warning, just press any key.
» Audio warning will be silenced and current time will be displayed.





Cancelling the alarm;

1. Touch  until  symbol appears on display in order to cancel the alarm.
2. Press and hold  key until "00:00" is displayed.



Alarm time will be displayed. If the alarm time and cooking time are set concurrently, shortest time will be displayed.





Changing the time of the day

1. Touch  key in short intervals until  symbol appears on display.
2. Touch  /  keys to set the hour.
3. Confirm the setting by touching  symbol and wait for 4 seconds without touching any keys to confirm.









Current time settings are canceled in case of power failure. It needs to be readjusted. Current time can not be changed when any of the oven functions is in use.

Adjusting the volume

1. While the oven is in Standby mode, touch  key in short intervals until 'VOL' appears on display.
2. Press  /  keys to set one of L0, L1 or L2 tones.
3. Press  key or wait for 4 seconds without touching any keys to confirm the setting

Adjusting the Eco lamp setting

1. While the oven is in Standby mode, touch  key in short intervals until 'LP' appears on display.
2. Press  /  keys to set On or ECO option.
3. Press  key or wait for 4 seconds without touching any keys to confirm the setting
4. When set to ON; while the oven door is open in Standby mode and during operation the lamp is turned ON continuously.
5. When set to ECO; while the oven door is open in Standby mode and during operation the lamp is turned ON and then turned OFF after 15 seconds.

If any key is touched during operation (excluding  and  keys) the lamp is turned ON and then turned OFF after 15 seconds.

Cooking times table



The timings in this chart are meant as a guide. Timings may vary due to temperature of food, thickness, type and your own preference of cooking.

Baking and roasting



1st rack of the oven is the **bottom** rack.

| Dish | Cooking level number | | Rack position | Temperature (°C) | Cooking time (approx. in min.) |
|----------------------------|----------------------|--|---------------|-----------------------------------|--------------------------------|
| Cakes in tray* | One level | | 3 | 175 | 25 ... 30 |
| Cakes in mould* | One level | | 2 | 180 | 40 ... 50 |
| Cakes in cooking paper* | One level | | 3 | 175 | 25 ... 30 |
| | 2 levels | | 1 - 5 | 175 | 30 ... 40 |
| | 3 levels | | 1 - 3 - 5 | 180 | 45 ... 55 |
| Sponge cake* | One level | | 3 | 200 | 5 ... 10 |
| | 2 levels | | 1 - 5 | 175 | 20 ... 30 |
| Cookies* | One level | | 3 | 175 | 25 ... 30 |
| | 2 levels | | 1 - 5 | 170 ... 190 | 30 ... 40 |
| | 3 levels | | 1 - 3 - 5 | 175 | 35 ... 45 |
| Dough pastry* | One level | | 2 | 200 | 30 ... 40 |
| | 2 levels | | 1 - 5 | 200 | 45 ... 55 |
| | 3 levels | | 1 - 3 - 5 | 200 | 55 ... 65 |
| Rich pastry* | One level | | 2 | 200 | 25 ... 35 |
| | 2 levels | | 1 - 5 | 200 | 35 ... 45 |
| | 3 levels | | 1 - 3 - 5 | 190 | 45 ... 55 |
| Leaven* | One level | | 2 | 200 | 35 ... 45 |
| | 2 levels | | 1 - 3 | 190 | 35 ... 45 |
| Lasagna* | One level | | 2 - 3 | 200 | 30 ... 40 |
| Pizza* | One level | | 2 | 200 ... 220 | 15 ... 20 |
| | One level | | 3 | 200 | 10 ... 15 |
| Beef steak (whole) / Roast | One level | | 3 | 25 min. 250/max, then 180 ... 190 | 100 ... 120 |
| Leg of Lamb (casserole) | One level | | 3 | 25 min. 250/max, then 190 | 70 ... 90 |
| | One level | | 3 | 25 min. 250/max, then 190 | 60 ... 80 |
| Roasted chicken | One level | | 2 | 15 min. 250/max, then 180 ... 190 | 55 ... 65 |
| | One level | | 2 | 15 min. 250/max, then 180 ... 190 | 55 ... 65 |
| Turkey (5.5 kg) | One level | | 1 | 25 min. 250/max, then 180 ... 190 | 150 ... 210 |
| | One level | | 1 | 25 min. 250/max, then 180 ... 190 | 150 ... 210 |
| Fish | One level | | 3 | 200 | 20 ... 30 |
| | One level | | 3 | 200 | 20 ... 30 |

When cooking with 2 trays at the same time, place the deeper tray on the upper rack and the other one on the lower rack.
* It is suggested to perform preheating for all foods.

Slow cooking/Eco Fan Heating



Do not change the cooking temperature after cooking starts in Slow cooking/Eco Fan Heating mode.



Do not open the door during cooking in the Slow cooking/Eco Fan Heating mode.

| Dish | Cooking level number | | Rack position | Temperature (°C) | Cooking time (approx. in min.) |
|------------------------|----------------------|--|---------------|------------------|--------------------------------|
| Meat-Casserole | One level | | 3 | 160 | 100 ... 120 |
| Chicken-Casserole | One level | | 3 | 160 | 70 ... 100 |
| Haricot Bean | One level | | 3 | 160 | 130 ... 150 |
| Eggplant-Casserole | One level | | 3 | 160 | 130 ... 150 |
| Steak – Whole | One level | | 3 | 160 | 110 ... 130 |
| Steak – Sliced | One level | | 3 | 160 | 100 ... 120 |
| Cakes in cooking paper | One level | | 3 | 185 | 35 ... 40 |
| Cookies | One level | | 3 | 185 | 30 ... 35 |
| Dough pastry | One level | | 3 | 200 | 40 ... 45 |
| Rich pastry | One level | | 3 | 200 | 40 ... 45 |

- Perform a preheating for 6-7 minutes.
- White/red meats have to be flipped over in the pan prior to cooking until boiled down.
- Haricot beans have to be boiled for 30 minutes prior to cooking. You may directly use canned bean.
- Covering the cooking pan will increase performance of cooking.

Tips for baking cake

- If the cake is too dry, increase the temperature by 10°C and decrease the cooking time.
- If the cake is wet, use less liquid or lower the temperature by 10°C.
- If the cake is too dark on top, place it on a lower rack, lower the temperature and increase the cooking time.
- If cooked well on the inside but sticky on the outside use less liquid, lower the temperature and increase the cooking time.

Tips for baking pastry

- If the pastry is too dry, increase the temperature by 10°C and decrease the cooking time. Dampen the layers of dough with a sauce composed of milk, oil, egg and yoghurt.
- If the pastry takes too long to bake, pay care that the thickness of the pastry you have prepared does not exceed the depth of the tray.
- If the upper side of the pastry gets browned, but the lower part is not cooked, make sure that the amount of sauce you have used for the pastry is not too much at the bottom of the pastry. Try to scatter the sauce equally between the dough layers and on the top of pastry for an even browning.



Cook the pastry in accordance with the mode and temperature given in the cooking table. If the bottom part is still not browned enough, place it on one lower rack next time.

Tips for cooking vegetables

- If the vegetable dish runs out of juice and gets too dry, cook it in a pan with a lid instead of a tray. Closed vessels will preserve the juice of the dish.
- If a vegetable dish does not get cooked, boil the vegetables beforehand or prepare them like canned food and put in the oven.

How to operate the grill



WARNING

Close oven door during grilling.
Hot surfaces may cause burns!

Switching on the grill

1. First operating function appears on display after touching button to open the oven.
2. Touch to select the desired grill function.
3. If you desire to change the temperature that is recommended for operating function, enable the temperature field by touching button.
 - » symbol flashes.
4. Set the desired temperature touching keys.
5. Confirm the temperature setting by touching key.
6. Touch key to start grilling if temperature and operating function are appropriate. symbol appears on display.
 - » Your oven will readily start operating in the selected function and will increase the inner temperature to the set temperature. Each grades of the inner temperature

symbol will be lit as inner temperature reaches to the set temperature. Additional active heaters and recommended tray position appear in the Function display.

7. You can finish grilling by touching button once again.
 - » The oven finishes grilling and symbol appears on display.

Switching off the grill

1. Touch the button for approx. 2 seconds to close the oven.



Foods that are not suitable for grilling carry the risk of fire. Only grill food which is suitable for intensive grilling heat.

Do not place the food too far in the back of the grill. This is the hottest area and fatty food may catch fire.

Cooking times table for grilling

Grilling with electric grill

| Food | Insertion level | Grilling time (approx.) |
|----------------|-----------------|--------------------------|
| Fish | 4..5 | 20..25 min. [#] |
| Sliced chicken | 4..5 | 25..35 min. |
| Lamb chops | 4..5 | 20..25 min. |
| Roast beef | 4..5 | 25..30 min. [#] |
| Veal chops | 4..5 | 25..30 min. [#] |
| Toast bread | 4 | 1..2 min. |

[#] depending on thickness

6 Maintenance and care

General information

Service life of the product will extend and the possibility of problems will decrease if the product is cleaned at regular intervals.

**DANGER:**

Disconnect the product from mains supply before starting maintenance and cleaning works.
There is the risk of electric shock!

**DANGER:**

Allow the product to cool down before you clean it.
Hot surfaces may cause burns!

- Clean the product thoroughly after each use. In this way it will be possible to remove cooking residues more easily, thus avoiding these from burning the next time the appliance is used.
- No special cleaning agents are required for cleaning the product. Use warm water with washing liquid, a soft cloth or sponge to clean the product and wipe it with a dry cloth.
- Always ensure any excess liquid is thoroughly wiped off after cleaning and any spillage is immediately wiped dry.
- Do not use cleaning agents that contain acid or chloride to clean the stainless or inox surfaces and the handle. Use a soft cloth with a liquid detergent (not abrasive) to wipe those parts clean, paying attention to sweep in one direction.



The surface might get damaged by some detergents or cleaning materials.
Do not use aggressive detergents, cleaning powders/creams or any sharp objects during cleaning.
Do not use harsh abrasive cleaners or sharp metal scrapers to clean the oven door glass since they can scratch the surface, which may result in shattering of the glass.



Do not use steam cleaners to clean the appliance as this may cause an electric shock.

Cleaning the control panel

Clean the control panel and knobs with a damp cloth and wipe them dry.



Do not remove the control buttons/knobs to clean the control panel.
Control panel may get damaged!

Cleaning the oven

To clean the side wall

(This feature is optional. It may not exist on your product.)

1. Remove the front section of the side rack by pulling it in the opposite direction of the side wall.
2. Remove the side rack completely by pulling it towards you.

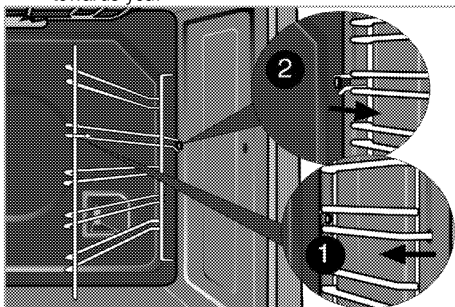

Catalytic walls

(This feature is optional. It may not exist on your product.)

The inner side walls (A) and/or the rear wall (B) of your product may be coated with catalytic enamel. Catalytic walls have a light matte colour and a porous surface. Catalytic walls of the oven should not be cleaned. Porous surfaces of the catalytic walls are automatically cleaned by absorbing and converting the spilled oil (steam and carbon dioxide).

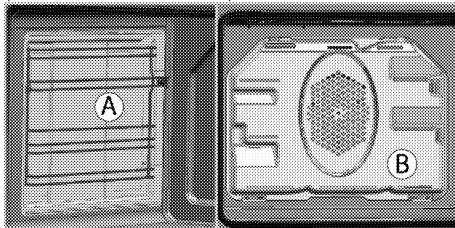

Pyrolytic self-cleaning

**DANGER:**

Hot surfaces cause burns!

Do not touch the product during self cleaning step and keep children away from it. Keep at least 30 minutes before removing the remnants.

The oven is equipped with pyrolytic self-cleaning. The oven is heated to approx. 480 °C and existing dirt is burned to ashes. A strong smoke development may

arise. Provide for good ventilation. The pyrolysis should be used after approx. every 10th oven usage.



1. Remove all accessories from the oven. In models with side rack; do not forget to take out the side racks.

If your product is equipped with a pyro proof accessory (Resilient against self-cleaning at high temperatures), you do not need to remove these accessories from the oven.

2. Before the cleaning cycle, remove dirt from exterior surfaces and oven interior with a damp cloth.

i Do not clean the door gasket. Fiberglass gasket is highly sensitive and can get damaged easily. In case of a damage on the oven door gasket, replace with the new one from the authorized service.

3. "Pyrolysis"  Select the pyrolytic function (self-cleaning).

 It is advised to use economic cleaning function if the oven does not have too much dirt. If this function is used for heavy dirt, there won't be sufficient cleaning. For such cases, pyrolysis function  should be applied after economic cleaning  cycle finished.

The self-cleaning time appears in the display. This duration can not be adjusted.

The end of self cleaning cycle can be adjusted.

4. Oven door cannot be opened and lock symbol  appears on the time display during self cleaning. It remains locked for a while after the pyrolysis function ends. Do not force the door lock with

handle until lock symbol  disappears.

5. After a clean cycle, remove soil deposits with vinegar water.

Clean oven door

To clean the oven door, use warm water with washing liquid, a soft cloth or sponge to clean the product and wipe it with a dry cloth.

i Don't use any harsh abrasive cleaners or sharp metal scrapers for cleaning the oven door. They could scratch the surface and destroy the glass.

Removing the oven door

1. Open the front door (1).
2. Open the clips at the hinge housing (2) on the right and left hand sides of the front door by pressing them down as illustrated in the figure.

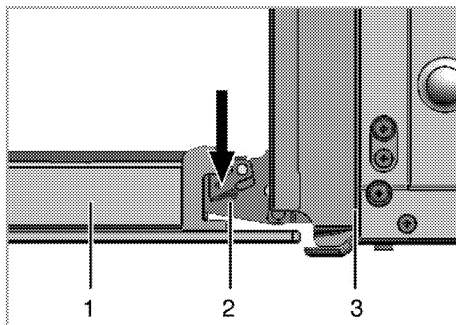

- 1 Front door
- 2 Hinge
- 3 Oven

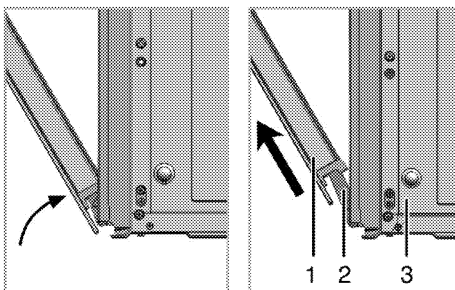

3. Move the front door to half-way.
4. Remove the front door by pulling it upwards to release it from the right and left hinges.

i Steps carried out during removing process should be performed in reverse order to install the door. Do not forget to close the clips at the hinge housing when reinstalling the door.

Removing the door inner glass

(This feature is optional. It may not exist on your product.)

The inner glass panel of the oven door can be removed for cleaning.

1. Open the oven door.

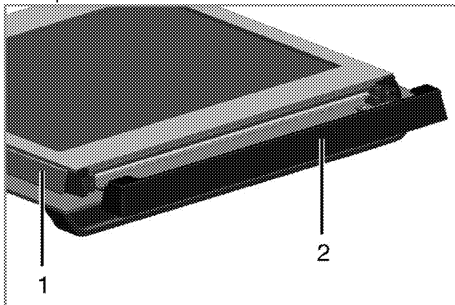

- 1 Frame

- 2 Plastic part
2. Pull towards yourself and remove the plastic part installed to upper section of the front door.

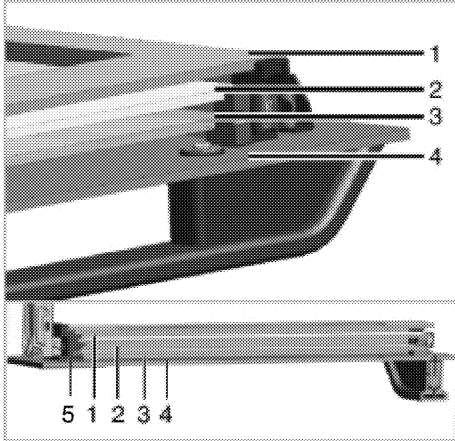

- 1 Innermost glass panel
- 2 Second inner glass panel
- 3 Third inner glass panel
- 4 Outer glass panel
- 5 Plastic glass panel slot-Lower
3. As illustrated in figure, raise the innermost glass panel slightly in direction **A** and pull it out in direction **B**.

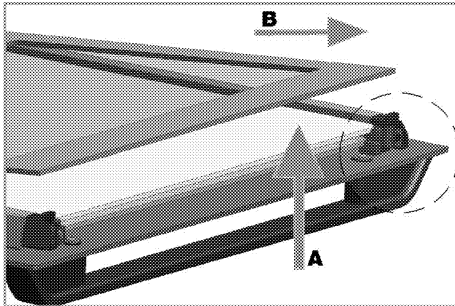

4. Repeat the same procedure to remove the second and third glass panels.

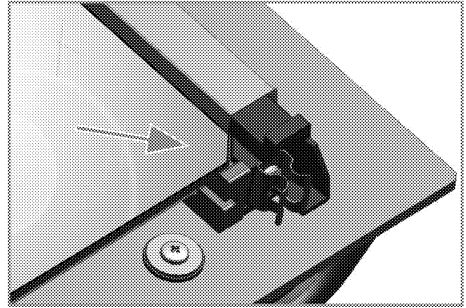

The first step to regroup the door is reinstalling second and third inner glass panels (2, 3).

As illustrated in figure, place the chamfered corner of the glass panel so that it will rest in the chamfered corner of the plastic slot.

Since the second and third inner glass panels are interchangeable, their order of installation is not important.

When installing the innermost glass panel (1), make sure that the printed side of the panel faces towards the second glass panel.

It is important to seat lower corners of all inner glass panels into the lower plastic slots (5).

Push the plastic part towards the frame until you hear a "click".



All glass panels must be reinstalled after cleaning.

Replacing the oven lamp



DANGER:

Before replacing the oven lamp, make sure that the product is disconnected from mains and cooled down in order to avoid the risk of an electrical shock.

Hot surfaces may cause burns!



The oven lamp is a special electric light bulb that can resist up to 300 °C. See *Technical specifications, page 11* for details. Oven lamps can be obtained from Authorised Service Agents or technician with licence.



Position of lamp might vary from the figure.



The lamp used in this appliance is not suitable for household room illumination. The intended purpose of this lamp is to assist the user to see foodstuffs.



The lamps used in this appliance have to withstand extreme physical conditions such as temperatures above 50 °C.

If your oven is equipped with a round lamp:

1. Disconnect the product from mains.
2. Turn the glass cover counter clockwise to remove it.

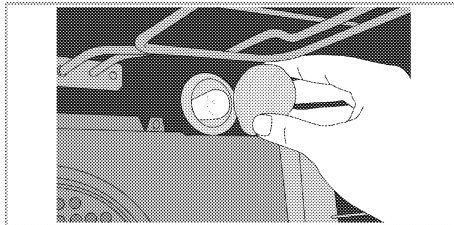

3. If your oven lamp is of type (A) shown in the figure below, remove it by rotating as shown and replace it. If it is of type (B), pull and remove it as shown in the figure and replace it.

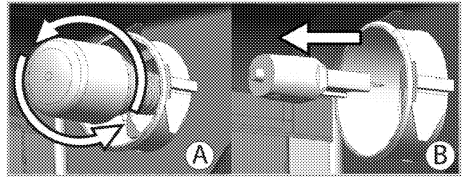

4. Install the glass cover.

If your oven is equipped with a square lamp:

1. Disconnect the product from mains.
2. Remove the wire racks as described. See *Cleaning the oven, page 29*.

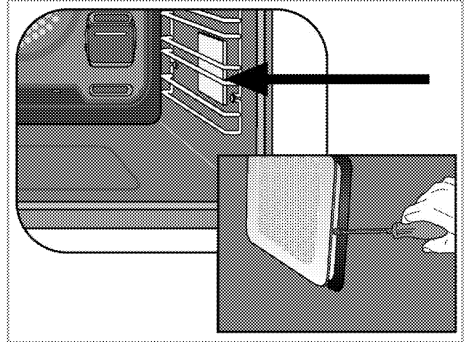

3. Remove the protective glass cover with a screwdriver.
4. If your oven lamp is of type (A) shown in the figure below, remove it by rotating as shown and replace it. If it is of type (B), pull and remove it as shown in the figure and replace it.

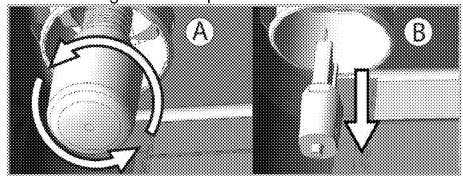

5. Install the glass cover and then the wire racks.

7 Troubleshooting

Oven emits steam when it is in use.

- It is normal that steam escapes during operation. >>> *This is not a fault.*

Product emits metal noises while heating and cooling.

- When the metal parts are heated, they may expand and cause noise. >>> *This is not a fault.*

Product does not operate.

- The mains fuse is defective or has tripped. >>> *Check fuses in the fuse box. If necessary, replace or reset them.*
- Product is not plugged into the (grounded) socket. >>> *Check the plug connection.*

Oven light does not work.

- Oven lamp is defective. >>> *Replace oven lamp.*
- Power is cut. >>> *Check if there is power. Check the fuses in the fuse box. If necessary, replace or reset the fuses.*

Oven does not heat.

- Function and/or Temperature are not set. >>> *Set the function and the temperature with the Function and/or Temperature knob/key.*
- Power is cut. >>> *Check if there is power. Check the fuses in the fuse box. If necessary, replace or reset the fuses.*



Consult the Authorised Service Agent or technician with licence or the dealer where you have purchased the product if you can not remedy the trouble although you have implemented the instructions in this section. Never attempt to repair a defective product yourself.

8 Guarantee Details

Your new Beko product is guaranteed against faulty materials, defective components or manufacturing defects. The guarantee starts from the date of original purchase of the product for a period of twelve (12) months unless Beko plc (the "Manufacturer") agrees to extend the guarantee for the product in writing. If you have any questions about the guarantee on your product (including how long it is valid), please contact your retailer or our Call Centre on 0333 207 9710.

This guarantee does not in any way diminish or affect your statutory rights in connection with the product. This guarantee is in addition to your statutory rights as a consumer. If you have any questions about these rights, please contact the retailer from which you purchased the product. In certain circumstances, it is possible that your statutory rights may offer additional or higher levels of protection than those offered under the terms of this guarantee.

What is covered by this guarantee?

- Repairs to the product required as a result of faulty materials, defective components or manufacturing defects.
- Functional replacement parts to repair a product.
- The costs of a Beko Approved Engineer to carry out the repair.

What is not covered?

- Transit and delivery damage.
- Cabinet or appearance parts, including but not limited to control knobs, flaps and handles.
- Accessories and/or consumable items including but not limited to ice trays, scrapers, cutlery baskets, filters and light bulbs.
- Repairs necessary as a direct or indirect result of:
 - Accidental damage, misuse or abuse of a product.
 - An attempted repair of a product by anyone other than a Beko authorised repairer.
 - Installation or use of a product where such installation or use fails to meet the requirements contained in this guarantee or the User Instructions Booklet.
- Repairs to a product operated at any time on commercial or non-residential household premises (unless we have previously agreed to the installation environment).

This guarantee is limited to the cost of repairing the product. To the extent permitted by law, the Manufacturer does not accept and will not be held liable for any financial loss incurred in connection with the failure of any product to operate in accordance with the expected standards. Such financial loss includes but is not limited to loss arising from:

- Time taken off work.
- Damaged food, clothing or other items.
- Meals taken at restaurants or from takeaways.
- General compensation for inconvenience.

Important Notes

- Your product is designed and built for domestic household use only.
- The guarantee will automatically be void if the product is installed or is used in commercial or non-residential domestic household premises, unless we have previously agreed to the installation environment.
- The product must be correctly installed, located and operated in accordance with the instructions contained in the User Instructions Booklet provided with your product.
- Professional installation by a qualified Electrical Domestic Appliance Installer is recommended for all Washing Machines, Dishwashers and Electric Cookers (as incorrect installation may result in you having to pay for the cost of repairing the product).
- Gas Cookers must be professionally installed by a Gas Safe (or Gas Networks Ireland for Republic of Ireland) registered gas installer.

- This guarantee is given in respect of products purchased and used within the United Kingdom and the Republic of Ireland.
- This guarantee is effective from the initial date of purchase of a new product from an authorised retailer and will be void if the product is resold.
- This guarantee does not apply to graded sales (where the product is purchased as a “second”).
- Possession of a copy of these terms and conditions does not necessarily mean that a product has the benefit of this guarantee. If you have any questions, please call our Call Centre on the number set out above.
- The Manufacturer reserves the right to terminate the guarantee if its staff or representatives are subjected to physical or verbal abuse in the course of carrying out their duties.
- Optional extras, where available (i.e. extendable feet) are supplied on a chargeable basis only.

Does Beko offer replacements?

This is a repair-only guarantee. On occasion, the Manufacturer may at its sole discretion, replace your product with a new product instead of carrying out a repair. Where a replacement is offered, this would normally be an identical model but when this is not possible, a model of similar specification will be provided. The Manufacturer will cover the costs and arrange for the delivery of the new product and for the return of the old product. Any costs related to disconnecting the faulty product and installing the replacement product will not be borne by the Manufacturer unless previously agreed to in writing. The original guarantee will continue to apply to the replacement product; the new product will not come with a new guarantee.

When will the repair take place?

Our Engineers work Monday to Friday 9.00am to 5.00pm. Appointments outside these hours may be possible at the sole discretion of the Manufacturer but cannot be guaranteed. Whilst our Engineers will endeavour to minimize inconvenience and to meet requests for specific timed appointments, this cannot be guaranteed. We will not be liable for delays or if it is unable to carry out a repair because a convenient appointment cannot be arranged.

Will there be any charge for the repairs?

It is your responsibility to provide evidence to the Engineer that your product is covered by this guarantee with a proof of purchase. The Manufacturer reserves the right to charge for the reasonable cost of any service call if:

- You cannot provide evidence that your product is covered by this guarantee.
- Where a service call has been made and the engineer finds that there is no fault with your product.
- That your product has not been installed or operated in accordance with the User Instructions Booklet.
- That the fault was caused by something other than faulty materials, defective components or manufacturing defects.
- For missed appointments.

Payment of these costs are due immediately upon the Engineer providing you with an invoice. The Manufacturer reserves the right to terminate the guarantee if you fail to pay the costs for the service call in a timely manner.

If you are a resident of the United Kingdom, this guarantee will be governed by English law and subject to the English Courts, save where you live in another part of the United Kingdom, in which case the law and courts of that location will apply.

If you are resident in the Republic of Ireland, this guarantee will be governed by Irish law and the Irish courts will have jurisdiction.

HOW TO OBTAIN SERVICE

Please keep your purchase receipt or other proof of purchase in a safe place; you will need to have it should the product require attention under guarantee.

It will be useful if you complete the details below, as it will help us assist you when requesting service (the model number is printed on the Instruction Booklet and the serial number is printed on the Rating Label affixed to the appliance). Recording of these details alone will not count as proof of purchase. A valid proof of purchase is required for under guarantee service.

The area around the product must be easily accessible to the Engineer without the need for cabinets or furniture being removed.

It is your responsibility to ensure our Engineers have a clean and safe environment to carry out any repairs.

.....
Model No:

Serial No:

Retailer:

Date of purchase:
.....

For service under guarantee simply telephone the appropriate number below:

UK Mainland & Northern Ireland: 0333 207 9710 or customerservice@support.Beko.co.uk

Republic of Ireland: 01 862 3411 or customerservice@support.Beko.ie

Register your appliance: For UK registrations visit beko.co.uk/register and for the Republic of Ireland beko.ie/register.

Before requesting service please check the troubleshooting guide in the Operating Instructions as a charge may be levied where no fault is found even though your product may still be under guarantee.

Service once the manufacturers guarantee has expired

If you have purchased an extended guarantee please refer to the instructions contained within the extended guarantee agreement document, otherwise please call the appropriate number above where service can be obtained at a charge.

Should you experience any difficulty in obtaining service contact the Beko Customer Helpline on Tel: 0333 207 9710 or e-mail: CustomerService@support.beko.co.uk
.....

This guarantee is provided by Beko plc. Beko House, 1 Greenhill Crescent, Watford, Herts, WD18 8QU. Beko plc is registered in England and Wales with company registration number 02415578.

