

BS 530

# Oven

## User Manual



**Please read this manual first.**

Dear Customer,

We would like you to obtain the best performance from your product which has been manufactured in modern facilities under strict quality control procedures.

Therefore, we advise you to read through this User Manual carefully before using your product and keep it for future reference. If you hand over the product to someone else, deliver the User Manual as well.

**The User Manual will help you use the product in a fast and safe way.**

- Read the User Manual before installing and operating the product.
  - You must strictly observe the safety instructions.
  - Keep this User Manual within easy reach for future reference.
  - Also read other documents supplied with the product.
- Remember that this User Manual may also be applicable for several other models. Differences between models are explicitly identified in the manual.

### Explanation of symbols

Throughout this User Manual the following symbols are used:



Important information or useful hints about usage.



Warning for hazardous situations with regard to life and property.



Warning for electric shock.



Warning for risk of fire.



Warning for hot surfaces.



**Arçelik A.Ş.**  
Karaağaç caddesi No:2-6  
34445 Sülüce/İstanbul/TURKEY  
Made in TURKEY

## Table of Contents

### **1** General information **4**

Overview .....	4
Technical specifications .....	5
Package contents .....	6

### **2** Important safety instructions **7**

General safety .....	7
Safety for children .....	7
Safety when working with electricity .....	8
Intended use .....	8

### **3** Installation **9**

Before installation .....	9
Installation and connection .....	10
Compliance with EEE Directive .....	11
Package information .....	11
Future Transportation .....	11
Disposing of the old product .....	11

### **4** Preparation **12**

Tips for saving energy .....	12
Initial use .....	12
First cleaning of the appliance .....	12
Initial heating .....	12

### **5** How to use the hob **13**

General information about cooking .....	13
Using the hobs .....	13

### **6** How to operate the oven **15**

General information on baking, roasting and grilling .....	15
How to operate the electric oven .....	15
Operating modes .....	16
Cooking times table .....	17
How to operate the grill .....	18
Cooking times table for grilling .....	18

### **7** Maintenance and care **19**

General information .....	19
Cleaning the hob .....	19
Cleaning the control panel .....	19
Cleaning the oven .....	19
Removing the oven door .....	20
Removing the door inner glass .....	20
Replacing the oven lamp .....	21

### **8** Troubleshooting **22**

### **9** Guarantee and Service **23**

# 1 General information

## Overview

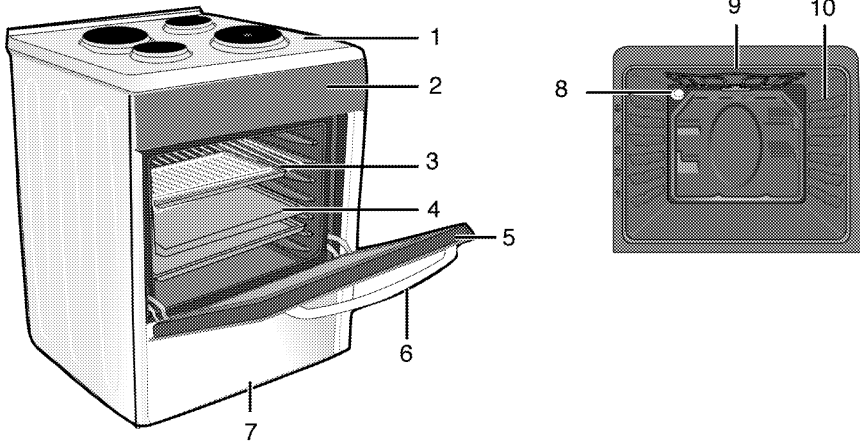

- |   |               |    |                                    |
|---|---------------|----|------------------------------------|
| 1 | Burner plate  | 6  | Handle                             |
| 2 | Control panel | 7  | Lower Part                         |
| 3 | Wire shelf    | 8  | Lamp                               |
| 4 | Tray          | 9  | Grill and top oven heating element |
| 5 | Door          | 10 | Shelf positions                    |

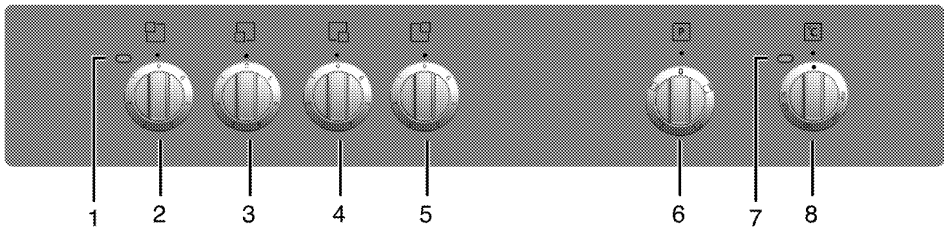



- |   |                      |   |                     |
|---|----------------------|---|---------------------|
| 1 | Warning lamp         | 5 | Hotplate Rear right |
| 2 | Hotplate Rear left   | 6 | Function knob       |
| 3 | Hotplate Front left  | 7 | Thermostat lamp     |
| 4 | Hotplate Front right | 8 | Thermostat knob     |

## Technical specifications

GENERAL	
External dimensions (height / width / depth)	850 mm/500 mm/600 mm
Voltage / frequency	220-240 V ~ 50 Hz
Total power consumption	7.9 kW
Fuse	min. 25 A
Cable type / section	H05VV-FG 3 x 2,5 mm <sup>2</sup> or equivalent
Cable length	max. 2 m
HOB	
Burners	
Rear left	<b>Hotplate</b>
Dimension	145 mm
Power	1000 W
Front left	<b>Hotplate</b>
Dimension	180 mm
Power	2000 W
Front right	<b>Hotplate</b>
Dimension	145 mm
Power	1500 W
Rear right	<b>Hotplate</b>
Dimension	180 mm
Power	1500 W
OVEN/GRILL	
Main oven	<b>Conventional oven</b>
Energy efficiency class <sup>#</sup>	A
Inner lamp	15-25 W
Grill power consumption	1.6 kW

<sup>#</sup> Basics: Information on the energy label of electrical ovens is given in accordance with the EN 50304 standard. Those values are determined under standard load with bottom-top heater or fan assisted heating (if any) functions.

 Technical specifications may be changed without prior notice to improve the quality of the product.

 Figures in this manual are schematic and may not exactly match your product.

 Values stated on the product labels or in the documentation accompanying it are obtained in laboratory conditions in accordance with relevant standards. Depending on operational and environmental conditions of the product, these values may vary.

## Package contents



Accessories supplied can vary depending on the product model. Not every accessory described in the user manual may exist on your product.

### User manual

### Wire Shelf

Used for roasting and for placing the food to be baked, roasted or cooked in casserole dishes to the desired rack.

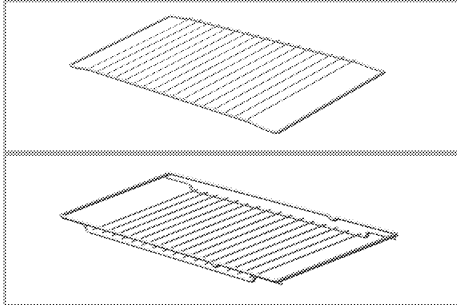

### Small wire shelf (used with the tray supplied with the product)

It is placed into the tray in order to collect the dripping fat while grilling so that the oven is kept clean.



## 2 Important safety instructions

This section contains safety instructions that will help you avoid risk of injury and damage. All warranties will become void if you do not follow these instructions.

### General safety

- This product is not intended to be used by persons with physical, sensory or mental disorders or unlearned or inexperienced people (including children) unless they are attended by a person who will be responsible for their safety or who will instruct them accordingly for use of the product. Children must be supervised to prevent them from tampering with the product.
- Connect the product to an earthed outlet/line protected by a fuse of suitable capacity as stated in the "Technical specifications" table. Have the earthing installation made by a qualified electrician while using the product with or without a transformer. Our company shall not be liable for any problems arising due to the product not being earthed in accordance with the local regulations.
- If the supply cord is damaged, it must be replaced by the manufacturer, its service agent or similarly qualified persons in order to avoid a hazard.
- Do not operate the product if it is defective or has any visible damage.
- Do not carry out any repairs or modifications on the product. However, you may remedy some troubles that do not require any repairs or modifications. See *Troubleshooting, page 22*.
- Never wash down the product with water! There is the risk of electric shock!
- Never use the product when your judgment or coordination is impaired by the use of alcohol and/or drugs.
- Product must be disconnected from the mains during installation, maintenance, cleaning and repair procedures.
- Be careful when using alcoholic drinks in your dishes. Alcohol evaporates at high temperatures and may cause fire since it can

ignite when it comes into contact with hot surfaces.

- Do not heat closed tins and glass jars in the oven. The pressure that would build-up in the tin/jar may cause it to burst.
- Do not place any flammable materials close to the product as the sides may become hot during use.
- Do not place baking trays, dishes or aluminium foil directly onto the bottom of the oven, as the heat accumulation might damage the bottom of the oven.
- Do not place aluminium foil on the base of the tray.
- Keep all ventilation slots clear of obstructions.
- Product may be hot when it is in use. Never touch the hot burners, inner sections of the oven, heaters and etc.
- Always use heat resistant oven gloves when putting in or removing dishes into/from the hot oven.
- Do not use the product with front door glass removed or cracked.
- Rear surface of the oven gets hot when it is in use. Make sure that the gas/electrical connection does not contact the rear surface; otherwise, connections can get damaged.
- Do not trap the mains cable between the oven door and frame and do not route it over hot surfaces. Otherwise, cable insulation may melt and cause fire as a result of short circuit.
- Make sure that the product function knobs are switched off after every use.

 The appliance is not intended to be operated by means of an external timer or separate remote control.

### Safety for children

- Electrical and/or gas products are dangerous to children. Keep children away from the product when it is operating and do not allow them to play with the product.
- Accessible parts of the appliance will become hot whilst the appliance is in use. Children should be kept away until the product has cooled down.



- "CAUTION: Accessible parts may be hot when the grill is in use. Young children should be kept away."
- Do not place any items above the appliance that children may reach for.
- When the door is open, do **not** load any heavy object on it and do **not** allow children to sit on it. It may overturn or door hinges may get damaged.
- The packaging materials will be dangerous for children. Keep the packaging materials away from children. Please dispose of all parts of the packaging according to environmental standards.

## SAVE THESE INSTRUCTIONS

### Safety when working with electricity

Defective electric equipment is one of the major causes of house fires.

- Any work on electrical equipment and systems should only be carried out by authorized and qualified persons.
- In case of any damage, switch off the product and disconnect it from the mains. To do this, turn off the fuse at home.
- Make sure that fuse rating is compatible with the product.

### Intended use

This product is designed for domestic use.

Commercial use will void the guarantee.

"CAUTION: This appliance is for cooking purposes only. It must not be used for other purposes, for example room heating."

This product should not be used for warming the plates under the grill, drying towels, dish cloths etc. by hanging them on the oven door handles. This product should also not be used for room heating purposes.

The manufacturer shall not be liable for any damage caused by improper use or handling errors.

The oven can be used for defrosting, baking, roasting and grilling food.

### 3 Installation

Product must be installed by a qualified person in accordance with the regulations in force. The manufacturer shall not be held responsible for damages arising from procedures carried out by unauthorized persons which may also void the warranty.



Preparation of location and electrical and gas installation for the product is under customer's responsibility.



#### DANGER

The product must be installed in accordance with all local gas and/or electrical regulations.



#### DANGER

**Prior to installation, visually check if the product has any defects on it. If so, do not have it installed.**

Damaged products cause risks for your safety.

#### Before installation

To ensure that critical air gaps are maintained under the appliance, we recommend that this appliance is mounted on a solid base and that the feet do not sink into any carpet or soft flooring.

The kitchen floor must be able to carry the weight of the appliance plus the additional weight of cookware and bakeware and food.

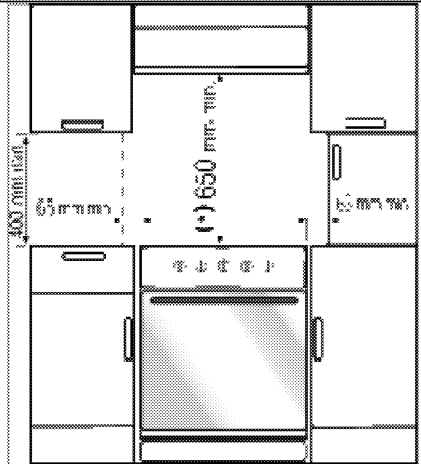

- It can be used with cabinets on either side but in order to have a minimum distance of 400mm above hotplate level allow a side clearance of 65mm between the appliance and any wall, partition or tall cupboard.
- It can also be used in a free standing position. Allow a minimum distance of 650 mm above the hob surface.
- (\*) If a cooker hood is to be installed above the cooker, refer to cooker hood manufacturer's instructions regarding installation height (min 650 mm).
- The appliance corresponds to device class 1, i.e. it may be placed with the rear and **one** side to kitchen walls, kitchen furniture or equipment of any size. The kitchen furniture or equipment on the **other** side may only be of the same size or smaller.
- Any kitchen furniture next to the appliance must be heat-resistant (100 °C min.).

## Installation and connection

Product can only be installed and connected in accordance with the statutory installation rules.



Do not install the appliance next to refrigerators or freezers. The heat emitted by the appliance will lead to an increased energy consumption of cooling appliances.

- Carry the product with at least two persons.
- Product must be placed directly on the floor. It must not be placed onto a base or a pedestal.



**Material damage!**  
The door and/or handle must not be used for lifting or moving the appliance.

### Electrical connection

Connect the product to a grounded outlet/line protected by a fuse of suitable capacity as stated in the "Technical specifications" table. Have the grounding installation made by a qualified electrician while using the product with or without a transformer. Our company shall not be liable for any damages that will arise due to using the product without a grounding installation in accordance with the local regulations.



**DANGER**  
**Risk of electric shock, short circuit or fire by unprofessional installation!**

The appliance may be connected to the mains supply only by an authorized qualified person and the appliance is only guaranteed after correct installation.



**DANGER**  
**Risk of electric shock, short circuit or fire by damage of the mains lead!**

The mains lead must not be clamped, bent or trapped or come into contact with hot parts of the appliance.  
If the mains lead is damaged, it must be replaced by a qualified electrician.

The mains supply data must correspond to the data specified on the type label of the product. The rating plate is either seen when the door or the lower cover is opened or it is located at the rear wall of the unit depending on the unit type. Power cable of your product must comply with the values in "Technical specifications" table.



### DANGER

#### Risk of electric shock!

Before starting any work on the electrical installation, please disconnect the appliance from the mains supply.

### Connecting the power cable

1. If a power cable is not supplied together with your product, a power cable that you would select from the table in accordance with the electrical installation at your home must be connected to your product by following the instructions in cable diagram. (Please consider technical data table, *Technical specifications*, page 5)

This product must only be installed by a qualified electrician eg local electricity company or NICEIC registered contractor to a suitable double-pole control unit with a minimum contact clearance of 3mm in all poles and with a minimum rating please consider technical data table, *Technical specifications*, page 5 which should be fitted adjacent to (but not above) the cooker in accordance with IEE regulations. Failure to observe this instruction may result in operational problems and invalidation of the product warranty.



Additional protection by a residual current circuit breaker is recommended.

2. The cable must have conductors of sufficiently high cross sectional area to prevent overheating and deterioration.

The mains cable must conform to BS6004. This appliance must be earthed.

The mains cable must pass through the cable clamp.

The mains cable should be routed away from the appliance and in particular ventilation slots, the vent outlet and should not be obstructed when pushed in to position between the appliance and the wall and/or cabinets.

3. Open the terminal block cover with a screwdriver.
4. Insert the power cable through the cable clamp below the terminal and secure it to the main body with the integrated screw on cable clamping component.

- Connect the cables according to the supplied diagram.

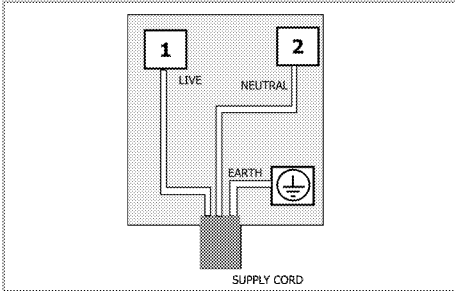

- After completing the wire connections, close the terminal block cover.
- Route the power cable so that it will not contact the product and get squeezed between the product and the wall.

**i** Power cable must not be longer than 2 m because of safety reasons.

- Push the product towards the kitchen wall.
- Adjusting the feet of oven**  
Vibrations during use may cause cooking vessels to move. This dangerous situation can be avoided if the product is level and balanced.  
For your own safety please ensure the product is level by adjusting the four feet at the bottom by turning left or right and align level with the work top.

### Final check

- Reconnect the product to the mains.
- Check electrical functions.

### Compliance with EEE Directive

This product does not contain harmful and forbidden materials described in the "Directive on the Restriction of the Use of Certain Hazardous Substances in Electrical and Electronic Equipment" (EEE) issued by the T.R. Ministry of Environment and Forest.

Complies with the EEE Directive.

### Package information

Packaging materials are dangerous to children. Keep packaging materials in a safe place out of reach of children.

Packaging materials of the product are manufactured from recyclable materials in

accordance with our National Environment Regulations.

Do not dispose of the packaging materials together with the domestic or other wastes. Take them to the packaging material collection points designated by the local authorities.

### Future Transportation

- Keep the product's original carton and transport the product in it. Follow the instructions on the carton. If you do not have the original carton, pack the product in bubble wrap or thick cardboard and tape it securely.
- To prevent the wire grill and tray inside the oven from damaging the oven door, place a strip of cardboard onto the inside of the oven door that lines up with the position of the trays. Tape the oven door to the side walls.
- Do not use the door or handle to lift or move the product.

**i** Do not place other items on the top of the appliance. The appliance must be transported upright.

**i** Check the general appearance of your product for any damages that might have occurred during transportation.

### Disposing of the old product



Dispose of the old product in an environmentally friendly manner.

This equipment bears the selective sorting symbol for waste electrical and electronic equipment (WEEE). This means that this equipment must be handled pursuant to European Directive 2002/96/EC in order to be recycled or dismantled to minimize its impact on the environment. For further information, please contact local or regional authorities.

Refer to your local dealer or solid waste collection centre in your area to learn how to dispose of your product.

Before disposing of the product, cut off the power cable plug and make the door lock (if any) unusable to avoid dangerous conditions to children.

## 4 Preparation

### Tips for saving energy

The following information will help you to use your appliance in an ecological way, and to save energy:

- Use dark coloured or enamel coated cookware in the oven since the heat transmission will be better.
- While cooking your dishes, perform a preheating operation if it is advised in the user manual or cooking instructions.
- Do not open the door of the oven frequently during cooking.
- Try to cook more than one dish in the oven at the same time whenever possible. You can cook by placing two cooking vessels onto the wire shelf.
- Cook more than one dish one after another. The oven will already be hot.
- You can save energy by switching off your oven a few minutes before the end of the cooking time. Do not open the oven door.
- Defrost frozen dishes before cooking them.
- Use pots/pans with cover for cooking. If there is no cover, energy consumption may increase 4 times.
- Select the burner which is suitable for the bottom size of the pot to be used. Always select the correct pot size for your dishes. Larger pots require more energy.
- Pay attention to use flat bottom pots when cooking with electric hobs. Pots with thick bottom will provide a better heat conduction. You can obtain energy savings up to 1/3.
- Vessels and pots must be compatible with the hotplates. Bottom of the vessels or pots must not be smaller than the hotplate.
- Keep the hotplates and bottom of the pots clean. Dirt will decrease the heat conduction between the hotplate and bottom of the pot.
- For long cookings, turn off the hotplate 5 or 10 minutes before the end of cooking time. You can obtain energy savings up to 20% by using the residual heat.

 Smell and smoke may emit during first heating. Ensure that the room is well ventilated.

### Initial use

#### First cleaning of the appliance



The surface may get damaged by some detergents or cleaning materials. Do not use aggressive detergents, cleaning powder/cream or any sharp objects.

1. Remove all packaging materials.
2. Wipe the surfaces of the appliance with a damp cloth or sponge and dry with a cloth.

#### Initial heating

Heat up the product for about 30 minutes and then switch it off. Thus, any production residues or layers will be burnt off and removed.



#### WARNING

##### Hot surfaces may cause burns!

Do not touch the hot surfaces of the appliance. Use oven gloves. Keep children away from the appliance.

#### Electric oven

1. Take all baking trays and the wire grill out of the oven.
2. Close the oven door.
3. Select Static position.
4. Select the highest oven power; See *How to operate the electric oven, page 15*.
5. Operate the oven for about 30 minutes.
6. Turn off your oven; See *How to operate the electric oven, page 15*

#### Grill oven

1. Take all baking trays and the wire grill out of the oven.
2. Close the oven door.
3. Select the highest grill power; see *How to operate the grill, page 18*.
4. Operate the grill about 30 minutes.
5. Turn off your grill; see *How to operate the grill, page 18*

#### Hot plate

1. Any production residues or conservation layers must be burnt before the first use. Operate the hotplate at middle temperature level for 8 minutes without any vessel on it. No pots or containers should be placed onto the hotplate during this procedure.

## 5 How to use the hob

### General information about cooking



#### DANGER

Risk of fire by overheated oil!

When you heat oil, do not leave it unattended.

**Never try to extinguish the fire with water!** When oil has caught fire, immediately cover the pot or pan with a lid. Switch off the hob if safe to do so and phone the fire service.

- Before frying foods, always dry them well and gently place into the hot oil. Ensure complete thawing of frozen foods before frying.
- Do not cover the vessel you use when heating oil.
- Place the pans and saucepans in a manner so that their handles are not over the hob to prevent heating of the handles. Do not place unbalanced and easily tilting vessels on the hob.
- Do not place empty vessels and saucepans on cooking zones that are switched on. They might get damaged.
- Operating a cooking zone without a vessel or saucepan on it will cause damage to the product. Turn off the cooking zones after the cooking is complete.
- As the surface of the product can be hot, do not put plastic and aluminum vessels on it. Such vessels should not be used to keep foods either.
- Use flat bottomed saucepans or vessels only.
- Put appropriate amount of food in saucepans and pans. Thus, you will not have to make any unnecessary cleaning by preventing the dishes from overflowing.  
Do not put covers of saucepans or pans on cooking zones.  
Place the saucepans in a manner so that they are centered on the cooking zone. When you want to move the saucepan onto another cooking zone, lift and place it onto the cooking zone you want instead of sliding it.

### Using the hobs

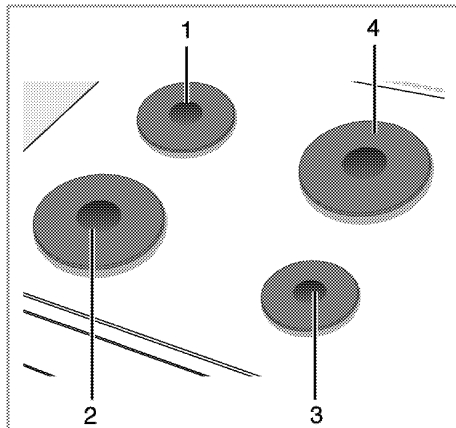

List of advised diameter of pots to be used on related burners.

- 1 Hotplate 14-16 cm
- 2 Hotplate 18-20 cm
- 3 Hotplate 14-16 cm
- 4 Hotplate 18-20 cm

## Using hotplates

Hob knobs can be turned in both directions in a way that will provide temperature control in steps.



If the hob is equipped with hotplates featuring Booster function, relevant hotplate will be marked with a red dot.

## Overheating protection

1000 Hotplates that have a power above 1000 W are equipped with an overheating protection.

Overheating protection decreases the power of the hotplate in following cases:

- There is no vessel or saucepan on the hotplate.
- There is an empty vessel or saucepan on the hotplate.
- The bottom of the vessel or saucepan is not flat.

## Turning on the hotplates

Use hotplate knobs to operate the hotplates. Move the hotplate knobs to the relevant level in order to obtain the desired cooking level.

Cooking level	1	2 — 3	4 — 6
	warming	stewing, simmering	boiling

## Turning off the hotplates

Turn the hotplate knob to OFF (upper) position.

## 6 How to operate the oven

### General information on baking, roasting and grilling



#### WARNING

Hot surfaces may cause burns!

Do not touch the hot surfaces of the appliance. Use oven gloves. Keep children away from the appliance.



#### DANGER

Risk of scalding by hot steam!

Take care when opening the oven door as steam may escape.

#### Tips for baking

- Use non-sticky coated appropriate metal plates or aluminum vessels or heat-resistant silicone moulds.
- Make best use of the space on the rack.
- Place the baking mould in the middle of the shelf.
- Select the correct rack position before turning the oven or grill on. Do not change the rack position when the oven is hot.
- Keep the oven door closed.

#### Tips for roasting

- Treating whole chicken, turkey and large piece of meat with dressings such as lemon juice and black pepper before cooking will increase the cooking performance.
- It takes about 15 to 30 minutes longer to roast meat with bones when compared to roasting the same size of meat without bones.
- Each centimeter of meat thickness requires approximately 4 to 5 minutes of cooking time.
- Let meat rest in the oven for about 10 minutes after the cooking time is over. The juice is better distributed all over the roast and does not run out when the meat is cut.
- Fish should be placed on the middle or lower rack in a heat-resistant plate.

#### Tips for grilling

- Grilling is a quick and healthy way of cooking meat, fish, vegetables and poultry. Flat pieces are particularly suitable for grilling.
- Distribute the pieces to be grilled on the wire shelf or in the baking tray with wire shelf in such a way that the space covered does not exceed the size of the heater.
- Slide the wire shelf or baking tray with grill into the desired level in the oven. If you are grilling on the wire shelf, slide the baking tray to the lower rack to collect fats. Add some water in the tray for easy cleaning.



#### Fire danger due to food which is unsuitable for grilling!

Only use food for grilling which is suitable for intensive grilling heat.

Do not place the food too far in the back of the grill. This is the hottest area and fat food may catch fire.

### How to operate the electric oven

#### Select temperature and operating mode



- 1 Function knob
- 2 Thermostat knob

1. Set the Temperature knob to the desired temperature.
2. Set the Function knob to the desired operating mode.

» Oven heats up to the adjusted temperature and maintains it. During heating, temperature lamp stays on.



## Switching off the electric oven

Turn the function knob and temperature knob to off (upper) position.

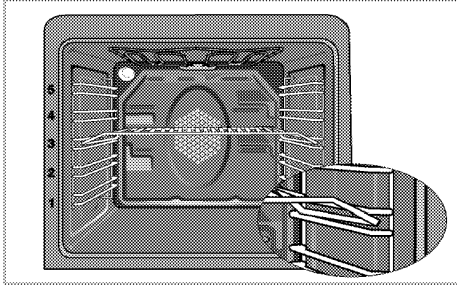

### Rack positions (For models with wire shelf)

It is important to place the wire shelf onto the side rack correctly. Wire shelf must be inserted between the side racks as illustrated in the figure. Do not let the wire shelf stand against the rear wall of the oven. Slide your wire shelf to the front section of the rack and settle it with the help of the door in order to obtain a good grill performance.

## Operating modes

The order of operating modes shown here may be different from the arrangement on your product.

### Top and bottom heating



Top and bottom heating are in operation. Food is heated simultaneously from the top and bottom. For example, it is suitable for cakes, pastries, or cakes and casseroles in baking moulds. Cook with one tray only.

### Bottom heating



Only bottom heating is in operation. It is suitable for pizza and for subsequent browning of food from the bottom.

### Grill



Small grill at the ceiling of the oven is in operation. Suitable for grilling.

- Put small or medium-sized portions in correct shelf position under the grill heater for grilling.
- Set the temperature to maximum level.
- Turn the food after half of the grilling time.

### Full grill



Large grill at the ceiling of the oven is in operation. It is suitable for grilling large amount of meat.

- Put big or medium-sized portions in correct rack position under the grill heater for grilling.
- Set the temperature to maximum level.
- Turn the food after half of the grilling time.

## Cooking times table



















The values indicated in the table below are data indicative. They may vary according to the type of food as well as your preferences of cooking.

## Baking and roasting



Level 1 is the **bottom** level in the oven.

Dish	Cooking level number		Rack position	Temperature (°C)	Cooking time (approx. in min.)
**Cakes in tray	One level		3	175	30 ... 45
**Cakes in mould	One level		3	175	30 ... 50
**Cakes in cooking paper	One level		3	160 ... 170	20 ... 30
**Sponge cake	One level		3	180 ... 200	10 ... 20
**Cookies	One level		3	160 ... 170	20 ... 30
**Dough pastry	One level		3	200	20 ... 30
**Rich pastry	One level		3	190	25 ... 35
**Leaven	One level		3	190	20 ... 40
**Lasagna	One level		2	180	25 ... 45
**Pizza	One level		2	200	15 ... 25
Beef steak (whole) / Roast	One level		2	25 min. 220, then 180 ... 190	80 ... 120
Leg of Lamb (casserole)	One level		2	25 min. 220, then 180 ... 190	70 ... 100
Roasted chicken	One level		2	15 min. 220, then 190	55 ... 75
Turkey (Sliced)	One level		2	25 min. 220, then 190	70 ... 120
Fish	One level		3	200	20 ... 30

(\*\*) In a cooking that requires preheating, preheat at the beginning of cooking until the thermostat lamp turns off.

### Tips for baking cake

- If the cake is too dry, increase the temperature by 10°C and decrease the cooking time.
- If the cake is wet, use less liquid or lower the temperature by 10°C.
- If the cake is too dark on top, place it on a lower rack, lower the temperature and increase the cooking time.
- If cooked well on the inside but sticky on the outside use less liquid, lower the temperature and increase the cooking time.

### Tips for baking pastry

- If the pastry is too dry, increase the temperature by 10°C and decrease the cooking time. Dampen the layers of dough with a sauce composed of milk, oil, egg and yoghurt.
- If the pastry takes too long to bake, pay care that the thickness of the pastry you have prepared does not exceed the depth of the tray.
- If the upper side of the pastry gets browned, but the lower part is not cooked, make sure that the amount of sauce you have used for the pastry is not too much at the bottom of the pastry. Try to scatter the sauce equally

between the dough layers and on the top of the pastry for an even browning.



Cook the pastry in accordance with the mode and temperature given in the cooking table. If the bottom part is still not browned enough, place it on one lower rack next time.

### Tips for cooking vegetables

- If the vegetable dish runs out of juice and gets too dry, cook it in a pan with a lid instead of a tray. Closed vessels will preserve the juice of the dish.
- If a vegetable dish does not get cooked, boil the vegetables beforehand or prepare them like canned food and put in the oven.

### How to operate the grill



#### WARNING

Hot surfaces may cause burns! Children must be kept away.  
When the door fully open, it remains tilted slightly, so that any spillage will be directed away from you.

### Switching on the grill

1. Open the grill door.
  2. Turn the Function knob to the desired grill symbol.
  3. Then selected the desired grilling temperature.
  4. If required, perform a preheating of about 5 minutes.
- » Temperature light turns on.

### Cooking times table for grilling

#### Grilling with electric grill

Food	Insertion level	Grilling time (approx.)
Fish	4	20...25 min. #
Sliced chicken	4	25...35 min.
Lamb chops	4	20...25 min.
Roast beef	4	25...30 min. #
Veal chops	4	25...30 min. #
Toast bread	4-5	1...2 min.

# depending on thickness

### Switching off the grill

1. Turn the Function knob to Off (top) position.

### Rack positions

Grill performance will decrease if the wire grill stands against rear part of the oven. Slide your wire grill to the front section of the rack and settle it with the help of the door in order to obtain the best grill performance.

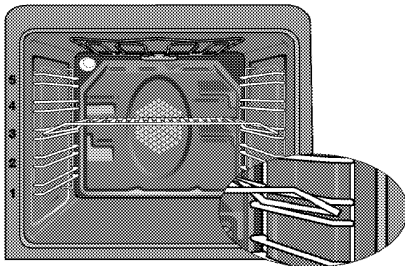

In addition to level 4, upper level (5) can be used for toasting bread. Thicker items such as those shown in the table below should not be used at upper level.



#### Fire danger due to food which is unsuitable for grilling!

Only use food for grilling which is suitable for intensive grilling heat.  
Do not place the food too far in the back of the grill. This is the hottest area and fat food may catch fire.

## 7 Maintenance and care

### General information

Service life of the product will extend and the possibility of problems will decrease if the product is cleaned at regular intervals.



#### DANGER

**Risk of electric shock!**

Switch off the electricity before cleaning appliance to avoid an electric shock.



#### DANGER

**Hot surfaces may cause burns!**

Allow the appliance to cool down before you clean it.

- Clean the product thoroughly after each use. In this way it will be possible to remove cooking residues more easily, thus avoiding these from burning the next time the appliance is used.
- No special cleaning agents are required for cleaning the product. Use warm water with washing liquid, a soft cloth or sponge to clean the product and wipe it with a dry cloth.
- Always ensure any excess liquid is thoroughly wiped off after cleaning and any spillage is immediately wiped dry.
- Do not use cleaning agents that contain acid or chloride to clean the stainless or inox surfaces and the handle. Use a soft cloth with a liquid detergent (not abrasive) to wipe those parts clean, paying attention to sweep in one direction.



The surface may get damaged by some detergents or cleaning materials.

Do not use aggressive detergents, cleaning powder/cream or any sharp objects.



Do not use steam cleaners for cleaning.

### Cleaning the hob

#### Electric hobs

1. Turn off the hotplates and wait until they cool down.
2. If necessary, clean the plates with a cleaning agent (you can obtain cleaners/softeners from specialty stores).
3. Warm only for a few minutes after cleaning in order to have their top section dried.
4. Apply a thin layer of machine oil onto the top surface of the hob regularly in order to protect it.

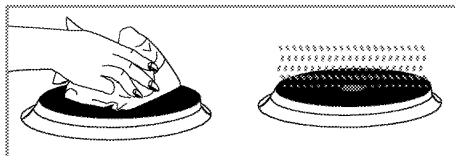

### Cleaning the control panel

Clean the control panel and control knobs with a damp cloth and wipe them dry.



Damage of the control panel!

Do not remove the control knobs for control panel cleaning.

### Cleaning the oven

#### Clean oven door

To clean the oven door, use warm water with washing liquid, a soft cloth or sponge to clean the product and wipe it with a dry cloth.



Don't use any harsh abrasive cleaners or sharp metal scrapers for cleaning the oven door. They could scratch the surface and destroy the glass.

## Removing the oven door

1. Open the front door (1).
2. Open the clips at the hinge housing (2) on the right and left hand sides of the front door by pressing them down as illustrated in the figure.

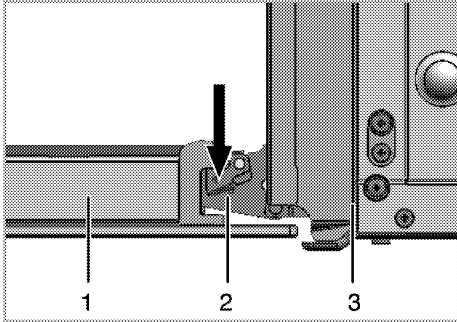

- 1 Front door
- 2 Hinge
- 3 Oven

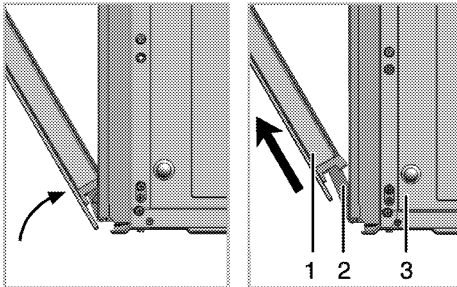

3. Move the front door to half-way.
4. Remove the front door by pulling it upwards to release it from the right and left hinges.

**i** Steps carried out during removing process should be performed in reverse order to install the door. Do not forget to close the clips at the hinge housing when reinstalling the door.

## Removing the door inner glass

The inner glass panel of the oven door can be removed for cleaning.

1. Open the oven door.

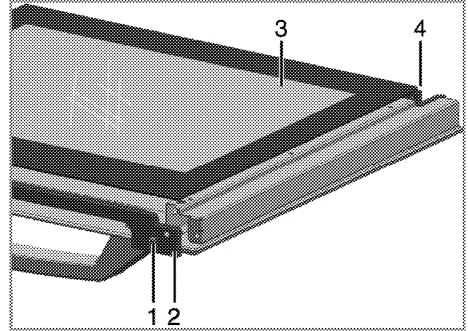

- 1 Screw
- 2 Plastic profile
- 3 Inner glass pane
- 4 Plastic slot

2. Using a screwdriver remove both screws (1) at the top of the door profile (one on each side).
3. Remove the door profile and carefully take out the glass (3).
4. When refitting the glass ensure the bottom edge of the glass is securely placed in the plastic slots. Refit the door profile using the screws.

## Replacing the oven lamp



### DANGER

Hot surfaces may cause burns!

Make sure that the appliance is switched off and cooled down in order to avoid the risk of an electrical shock.



The oven lamp is a special electric light bulb that can resist up to 300 °C. See *Technical specifications, page 5* for details. Oven lamps can be obtained from Authorised Service Agents.



Position of lamp might vary from the figure.

If your oven is equipped with a round lamp:

1. Disconnect the product from mains.
2. Turn the glass cover counter clockwise to remove it.

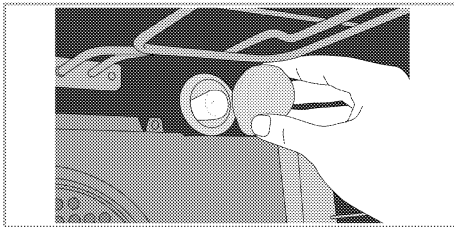

3. Remove the oven lamp by turning it counter clockwise and replace it with the new one.
4. Install the glass cover.

## 8 Troubleshooting

<b><i>Oven emits steam when it is in use.</i></b>	
It is normal that steam escapes during operation. This is not a fault.	
<b><i>Water drops occur during cooking</i></b>	
The vapour that arises during cooking can condense and form water droplets when it hits cold surfaces of the product. This is not a fault.	
<b><i>Product does not operate.</i></b>	
The mains fuse is defective or has tripped.	Check fuses in the fuse box. If necessary, replace or reset them.
<b><i>Oven light does not work.</i></b>	
Oven lamp is defective.	Replace oven lamp.
Power is cut.	Check if there is power. Check the fuses in the fuse box. If necessary, replace or reset the fuses.
<b><i>Oven does not heat.</i></b>	
Function and/or Temperature are not set.	Set the function and the temperature with the Function and/or Temperature knob/key.
In models equipped with a timer, the timer is not adjusted. (In products with microwave oven, timer controls only microwave oven.)	Adjust the timer.
Power is cut.	Check if there is power. Check the fuses in the fuse box. If necessary, replace or reset the fuses.
<b><i>(In models with timer) Clock display is blinking or clock symbol is on.</i></b>	
A previous power outage has occurred.	Adjust the timer / Switch of the product and switch it on again.
 Consult the Authorised Service Agent or the dealer where you have purchased the product if you can not remedy the trouble although you have implemented the instructions in this section. Never attempt to repair a defective product yourself.	

## 9 Guarantee and Service

Your Beko product is guaranteed against the cost of breakdown repairs : Freestanding appliances : 1 year  
Built-in appliances : 2 year  
from the date of the original purchase.

### What is covered?

- All repairs necessary as a result of faulty materials, defective components or manufacturing defect.
- The cost of all functional replacement parts.
- The labour costs of a Beko approved repairer to carry out the repair.

### What is not covered?

- Transit or delivery damage
- Accidental damage
- Misuse, or abuse.
- Cabinet or appearance parts, including knobs and flaps
- Accessory items, including ice trays, scrapers, cutlery baskets,
- Repairs required as a result of unauthorised repairs or inexpert installation that fails to meet the requirements contained in the user instruction book.

Repairs to products used on commercial or non-residential household premises.

### Important notes.

- The product is guaranteed for domestic household use only.
- The guarantee will be void if the product is installed or used in commercial or non-residential household premises.
- The product must be correctly installed, located and operated in accordance with the instructions contained in the User Instructions Booklet provided.
- Professional Installation by a qualified plumber/electrical appliance installer is recommended for all Washing & Dishwashing Machines and Electric Cookers
- Gas Cookers must only be installed by a Gas Safe (or BORD GAIS) registered Gas Installer.
- The guarantee is given only within the boundaries of the United Kingdom.
- The guarantee is not transferable if the product is resold.
- Beko plc disclaims any liability for incidental or consequential damages.
- The guarantee does not in anyway diminish your statutory or legal rights.

## HOW TO OBTAIN SERVICE UNDER THE MANUFACTURERS GUARANTEE

Please keep your purchase receipt or other proof of purchase in a safe place; you will need to have it should the product require attention in the guarantee period

You should also complete the details below; it will help us assist you quicker when requesting service. (The model number is printed on the Instruction Booklet)

Model Number: \_\_\_\_\_

Purchased From: \_\_\_\_\_

Date of purchase: \_\_\_\_\_

For service under guarantee simply telephone the appropriate number below

### LOCATION

### TELEPHONE

UK Mainland & Northern Ireland

Fridges & Freezers  
Electric Cookers  
Gas & Dual Fuel Cookers  
Washing Machines & Dishwashers

0845 600 4903  
0845 600 4902  
0845 600 4905  
0845 600 4906

Republic of Ireland

All Refrigeration, Cooking, Washing & Dishwashing Machines

01 862 3411

Before requesting service please check the trouble-shooting guide in the Operating Instructions as a charge may be levied where no fault is found even though your product may still be under guarantee.

Service once the manufacturers guarantee has expired.

If you have purchased an extended guarantee please refer to the instructions contained within the extended guarantee agreement document. Otherwise please call the above numbers where service can be obtained at a charge.

Should you experience any difficulty in obtaining service please call the

**Beko Customer Help-Line on 0845 600 4911**

**Beko House, Caxton Way, Watford, Herts, WD18 8UF, Tel: 0845 600 4911**

24.03.2011-v1









Beko plc  
Beko House  
Caxton Way  
Watford  
Herts WD18 8UF  
Tel: 0845 600 4911

Printed in Turkey  
Part no : 485.3002.89  
Rev: AA/ 11.05.2012