

Built-in Oven

User manual

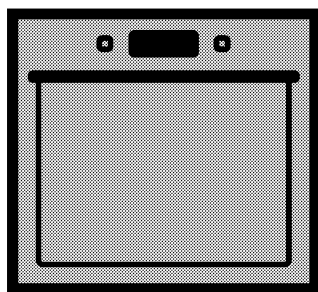

BVM34400BC

BXVM35400X

EN

285.4457.56/R.AA/16.02.2018

Please read this user manual first!

Dear Customer,

Thank you for purchasing this Beko product. We hope that you get the best results from your product which has been manufactured with high quality and state-of-the-art technology. Therefore, please read this entire user manual and all other accompanying documents carefully before using the product and keep it as a reference for future use. If you handover the product to someone else, give the user manual as well. Follow all warnings and information in the user manual.

Remember that this user manual is also applicable for several other models. Differences between models will be identified in the manual.

Explanation of symbols

Throughout this user manual the following symbols are used:

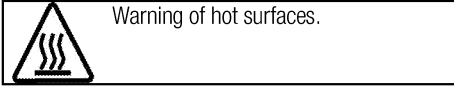
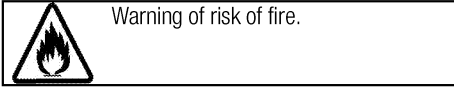
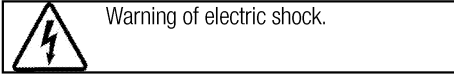
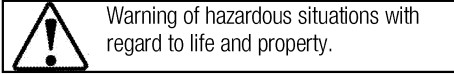
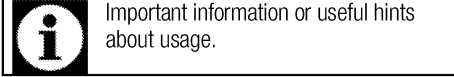

Arçelik A.Ş.
Karaağaç caddesi No:2-6
34445 Sütçüce/İstanbul/TURKEY
Made in TURKEY



This product was manufactured using the latest technology in environmentally friendly conditions.

TABLE OF CONTENTS

1 Important instructions and warnings for safety and environment 4

General safety	4
Electrical safety	4
Product safety	5
Intended use	7
Safety for children.....	7
Disposing of the old product	8
Package information	8

2 General information 9

Overview	9
Package contents	10
Technical specifications	11

3 Installation 12

Before installation	12
Installation and connection	13
Future Transportation.....	15

4 Preparation 16

Tips for saving energy	16
Initial use.....	16
Initial time setting	16
First cleaning of the appliance	17
Initial heating.....	17

5 How to operate the oven 18

General information on baking, roasting and grilling	18
How to operate the electric oven	18
Oven functions	20
How to operate the oven control unit	23
Cooking times table.....	34
How to operate the grill.....	36

6 Maintenance and care 38

General information	38
Cleaning the control panel	38
Cleaning the inside of oven	38
Removing the oven door	39
Removing the door inner glass	39
Replacing the oven lamp.....	40

7 Troubleshooting 42

8 Guarantee Details 43

1 Important instructions and warnings for safety and environment

This section contains safety instructions that will help protect from risk of personal injury or property damage. Failure to follow these instructions shall void any warranty.

General safety

- This appliance can be used by children aged from 8 years and above and persons with reduced physical, sensory or mental capabilities or lack of experience and knowledge if they have been given supervision or instruction concerning use of the appliance in a safe way and understand the hazards involved.
Children shall not play with the appliance. Cleaning and user maintenance shall not be made by children without supervision.
- The appliance is not to be used by persons (including children) with reduced physical, sensory or mental capabilities, or lack of experience and knowledge, unless they have been given supervision or instruction.
Children should be supervised and ensure they do not play with the appliance
- If the product is handed over to someone else for personal use or second-hand use purposes, the

user manual, product labels and other relevant documents and parts should be also given.

- Installation and repair procedures must always be performed by Authorised Service Agents. The manufacturer shall not be held responsible for damages arising from procedures carried out by unauthorised persons which may also void the warranty. Before installation, read the instructions carefully.
- Do not operate the product if it is defective or has any visible damage.
- Ensure that the product function knobs are switched off after every use.

Electrical safety

- If the product has a failure, it should not be operated unless it is repaired by an Authorised Service Agent. There is the risk of electric shock!
- Only connect the product to a grounded outlet/line with the voltage and protection as specified in the “Technical specifications”. Have the grounding installation made by a qualified electrician while using the product with or without a

transformer. Our company shall not be liable for any problems arising due to the product not being earthed in accordance with the local regulations.

- Never wash the product by spreading or pouring water onto it! There is the risk of electric shock!
- The product must be disconnected during installation, maintenance, cleaning and repairing procedures.
- If the power connection cable for the product is damaged, it must be replaced by the manufacturer, its service agent or similarly qualified persons in order to avoid a hazard.
- Only use the connection cable specified in the “Technical specifications”.
- The appliance must be installed so that it can be completely disconnected from the mains supply. The separation must be provided by a switch built into the fixed electrical installation, according to construction regulations.
- Rear surface of the oven gets hot when it is in use. Make sure that the electrical connection does not contact the rear surface; otherwise, connections can get damaged.

- Do not trap the mains cable between the oven door and frame and do not route it over hot surfaces. Otherwise, cable insulation may melt and cause fire as a result of short circuit.
- Any work on electrical equipment and systems should only be carried out by authorised and qualified persons.
- In case of any damage, switch off the product and disconnect it from the mains. To do this, turn off the fuse at home.
- Make sure that fuse rating is compatible with the product.

Product safety

- **WARNING:** The appliance and its accessible parts become hot during use. Care should be taken to avoid touching heating elements. Children less than 8 years of age shall be kept away unless continuously supervised.
- Never use the product when your judgment or coordination is impaired by the use of alcohol and/or drugs.
- Be careful when using alcoholic drinks in your dishes. Alcohol evaporates at high temperatures and may cause fire since it can ignite when it comes into contact with hot surfaces.
- **Food Poisoning Hazard:** Do not let food sit in oven for more than 1

hour before or after cooking. Doing so can result in food poisoning or sickness.

- Do not place any flammable materials close to the product as the sides may become hot during use.
- During use the appliances becomes hot. Care should be taken to avoid touching heating elements inside the oven.
- Keep all ventilation slots clear of obstructions.
- Do not heat closed tins and glass jars in the oven. The pressure that would build-up in the tin/jar may cause it to burst.
- Do not place baking trays, dishes or aluminium foil directly onto the bottom of the oven. The heat accumulation might damage the bottom of the oven.
- Do not use harsh abrasive cleaners or sharp metal scrapers to clean the oven door glass since they can scratch the surface, which may result in shattering of the glass.
- Do not use steam cleaners to clean the appliance as this may cause an electric shock.
- (Varies depending on the product model.)
Placing the wire shelf and tray onto the wire racks properly

It is important to place the wire shelf and/or tray onto the rack properly. Slide the wire shelf or tray between 2 rails and make sure that it is balanced before placing food on it (Please see the following figure).

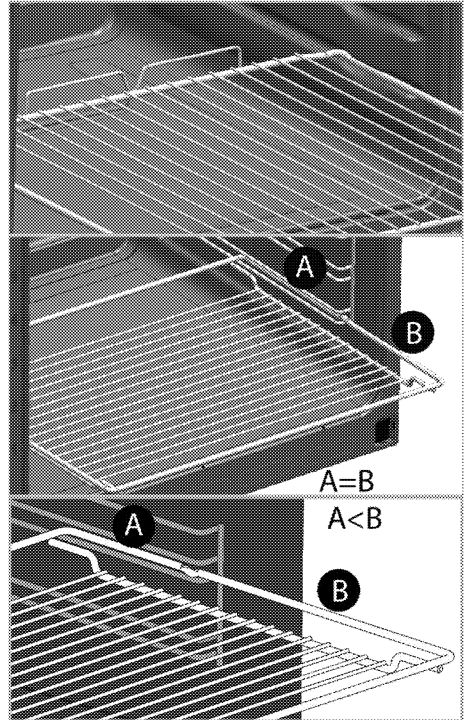

- Do not use the product if the front door glass removed or cracked.
- Do not use the oven handle to hang towels for drying. Do not hang up towel, gloves, or similar textile products when the grill function is at open door.
- Always use heat resistant oven gloves when putting in or removing dishes into/from the hot oven.

- Place the baking paper into the cooking pot or on to the oven accessory (tray, wire grill etc) together with the food and then insert all into the preheated oven. Remove the excess parts of the baking paper overflowing from the accessory or the pot in order to prevent the risk of touching the oven's heating elements. Never use the baking paper in an operating temperature higher than the indicated value for the baking paper. Do not place the baking paper directly on the base of the oven.
- **WARNING:** Ensure that the appliance is switched off before replacing the lamp to avoid the possibility of electric shock.
- The appliance must not be installed behind a decorative door in order to avoid overheating.

Prevention against possible fire risk!

- Ensure all electrical connections are secure and tight to prevent risk of arcing.
- Do not use damaged cables or extension cables.
- Ensure liquid or moisture is not accessible to the electrical connection point.

Intended use

- This product is designed for domestic use. Commercial use will void the guarantee.

- This appliance is for cooking purposes only. It must not be used for other purposes, for example room heating.
- This product should not be used for warming the plates under the grill, drying towels, dish cloths etc. by hanging them on the oven door handles. This product should also not be used for room heating purposes.
- The manufacturer shall not be liable for any damage caused by improper use or handling errors.
- The oven can be used for defrosting, baking, roasting and grilling food.

Safety for children

- **WARNING:** Accessible parts may become hot during use. Young children should be kept away.
- The packaging materials will be dangerous for children. Keep the packaging materials away from children. Please dispose of all parts of the packaging according to environmental standards.
- Electrical products are dangerous to children. Keep children away from the product when it is operating and do not allow them to play with the product.
- Do not place any items above the appliance that children may reach for.

- When the door is open, do not load any heavy object on it and do not allow children to sit on it. It may overturn or door hinges may get damaged.

Disposing of the old product

Compliance with the WEEE Directive and Disposing of the Waste Product:



This product complies with EU WEEE Directive (2012/19/EU). This product bears a classification symbol for waste electrical and electronic equipment (WEEE).

This product has been manufactured with high quality parts and materials which can be reused and are suitable for recycling. Do not dispose of the waste

product with normal domestic and other wastes at the end of its service life. Take it to the collection center for the recycling of electrical and electronic equipment. Please consult your local authorities to learn about these collection centers.

Compliance with RoHS Directive:

The product you have purchased complies with EU RoHS Directive (2011/65/EU). It does not contain harmful and prohibited materials specified in the Directive.

Package information

- Packaging materials of the product are manufactured from recyclable materials in accordance with our National Environment Regulations. Do not dispose of the packaging materials together with the domestic or other wastes. Take them to the packaging material collection points designated by the local authorities.

2 General information

Overview

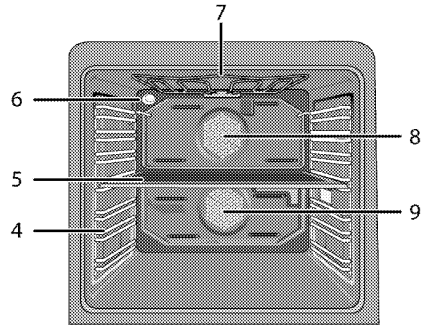
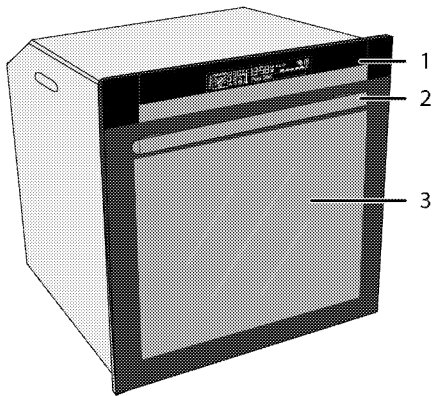

- 1 Control panel
- 2 Handle
- 3 Front door
- 4 Shelf positions
- 5 Middle section plate

- 6 Lamp
- 7 Top heating element
- 8 Top section fan motor (behind the sheet iron)
- 9 Bottom section fan motor (behind the sheet iron)

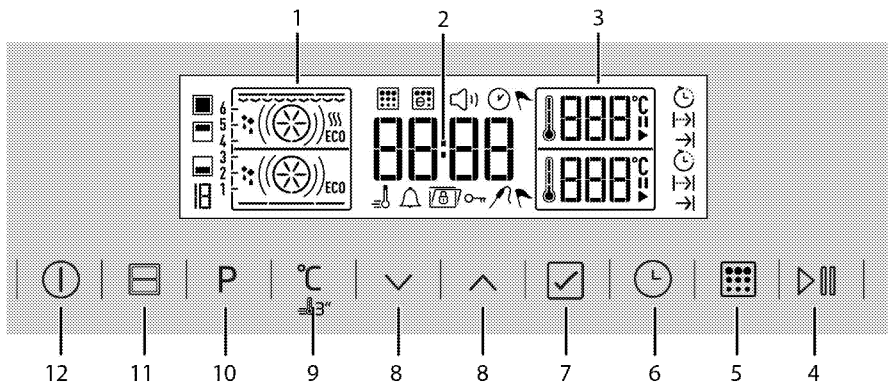

- 1 Function display
- 2 Current time indicator field
- 3 Temperature indicator field
- 4 Start/stop cooking key
- 5 Pyro key*
- 6 Time and settings key
- 7 Confirmation key

- 8 Up/down keys
- 8 Up/down keys
- 9 Temperature/booster setting key
- 10 Function selection key
- 11 Oven section selection key
- 12 ON/OFF key
- * (Varies depending on the product model.)

Package contents



Accessories supplied can vary depending on the product model. Not every accessory described in the user manual may exist on your product.

User manual

Oven tray

Used for pastries, frozen foods and big roasts.

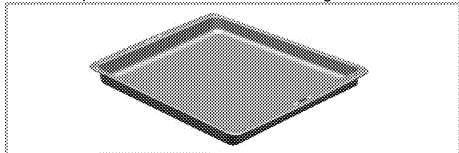

Wire Shelf

Used for roasting and for placing the food to be baked, roasted or cooked in casserole dishes to the desired rack.

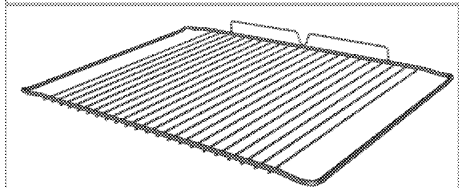
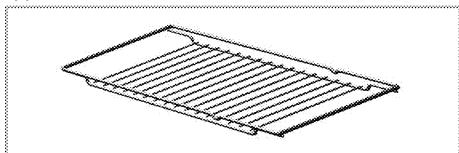

Small wire shelf

It is placed into the tray (if supplied) in order to collect the dripping fat while grilling so that the oven is kept clean.

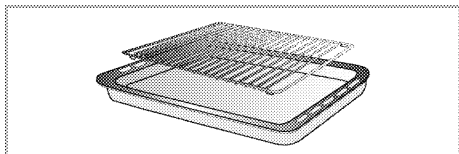

Placing the wire shelf and tray onto the telescopic racks properly

(This feature is optional. It may not exist on your product.)

Telescopic racks allow you to install and remove the trays and wire shelf easily.

When using the tray and wire shelf with telescopic racks, make sure that the pins at the rear section of the telescopic rack stands against the edges of the wire shelf and tray.

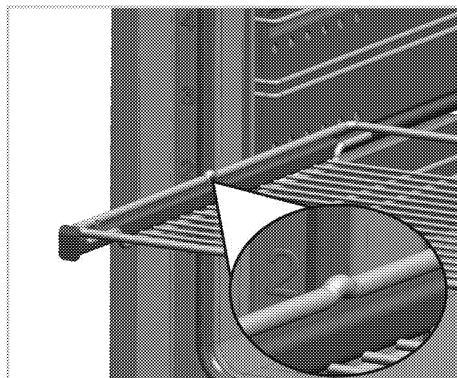
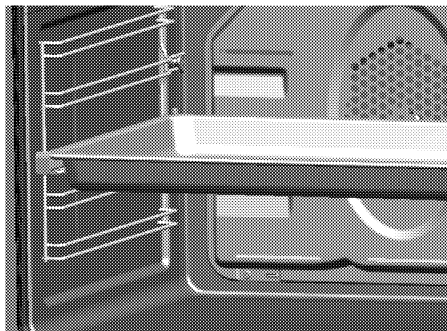

Technical specifications

Voltage / frequency	220-240 V ~ 50 Hz
Total power consumption	3,5kW
Fuse	16 A
Cable type / section	min.H05W-FG 3 x 1,5 mm ² or equivalent
External dimensions (height / width / depth)	595 mm/594 mm/567 mm
Installation dimensions (height / width / depth)	**590 or 600 mm/560 mm/min. 550 mm
Main oven	Multifunction oven - Dual section oven
Inner lamp	15/25 W
Grill power consumption	2,2 kW

Basics: Information on the energy label of electrical ovens is given in accordance with the EN 60350-1 / IEC 60350-1 standard. Those values are determined under standard load with bottom-top heater or fan assisted heating (if any) functions.
Energy efficiency class is determined in accordance with the following prioritization depending on whether the relevant functions exist on the product or not. 1-Cooking with eco-fan, 2- Turbo slow cooking, 3- Turbo cooking, 4- Fan assisted bottom/top heating, 5-Top and bottom heating.

** See. *Installation*, page 12.



Technical specifications may be changed without prior notice to improve the quality of the product.



Figures in this manual are schematic and may not exactly match your product.



Values stated on the product labels or in the documentation accompanying it are obtained in laboratory conditions in accordance with relevant standards. Depending on operational and environmental conditions of the product, these values may vary.

3 Installation

Product must be installed by a qualified person in accordance with the regulations in force. The manufacturer shall not be held responsible for damages arising from procedures carried out by unauthorized persons which may also void the warranty.



Preparation of location and electrical installation for the product is under the installer's responsibility.



DANGER:

The product must be installed in accordance with all local electrical regulations.



DANGER:

Prior to installation, visually check if the product has any defects on it. If so, do not have it installed.

Damaged products cause risks for your safety.

Before installation

The appliance is intended for installation in commercially available kitchen cabinets. A safety

distance must be left between the appliance and the kitchen walls and furniture. See figure (values in mm). Surfaces, synthetic laminates and adhesives used must be heat resistant (100 °C minimum). Kitchen cabinets must be set level and fixed. If there is a drawer beneath the oven, a shelf must be installed between oven and drawer. Carry the appliance with at least two persons. The following installation drawings are representational and may not match exactly with your appliance.



Do not install the appliance next to refrigerators or freezers. The heat emitted by the appliance will lead to an increased energy consumption of cooling appliances.



The door and/or handle must not be used for lifting or moving the appliance.



If the appliance has wire handles, push the handles back into the side walls after moving the appliance.

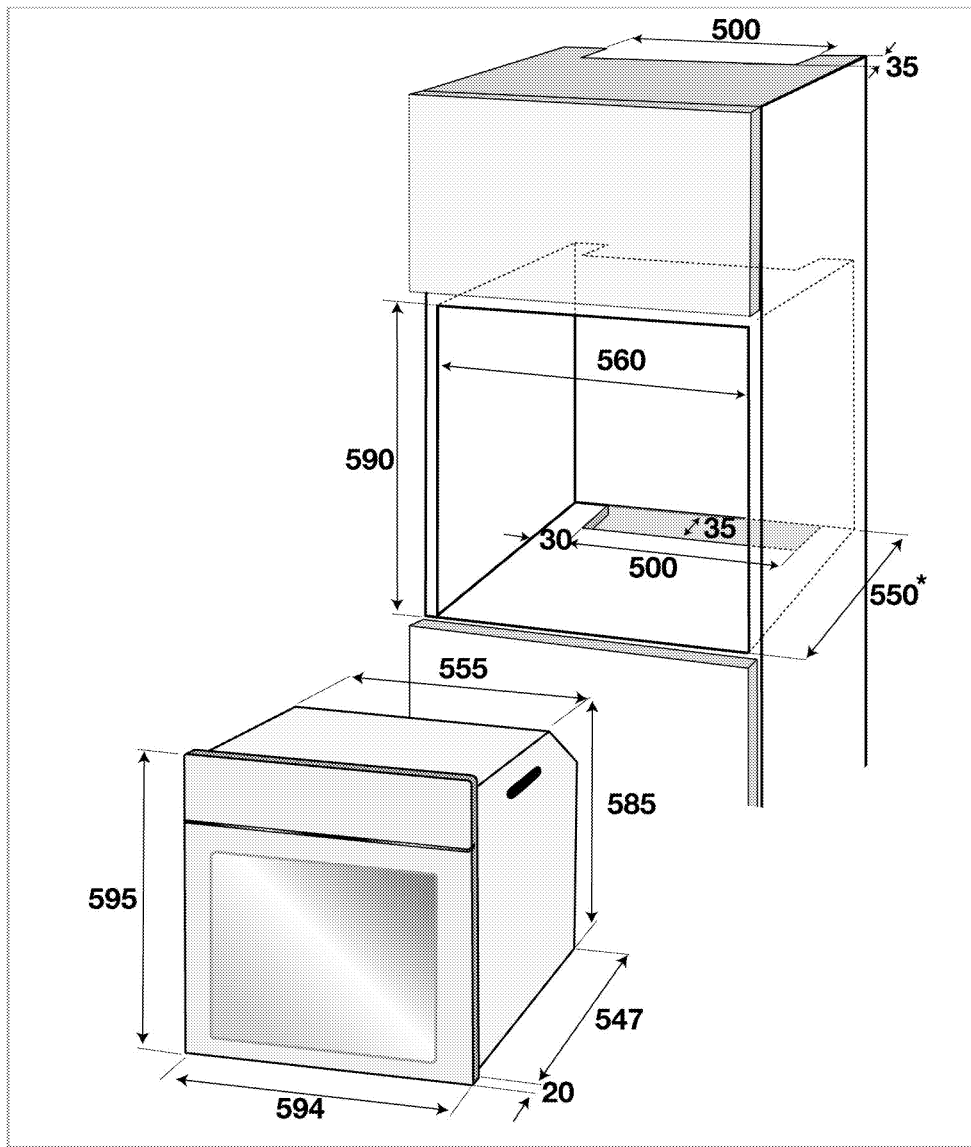

* min.

Installation and connection

The product must be installed in accordance with all local gas and electrical regulations.

Electrical connection

Connect the product to a grounded outlet/line protected by a fuse of suitable capacity as stated in the "Technical specifications" table. Have the grounding installation made by a qualified electrician

while using the product with or without a transformer. Our company shall not be liable for any damages that will arise due to using the product without a grounding installation in accordance with the local regulations.

**DANGER:**

The product must be connected to the mains supply only by an authorised and qualified person. Manufacturer shall not be held responsible for damages arising from procedures carried out by unauthorised persons.

**DANGER:**

The power cable must not be clamped, bent or trapped or come into contact with hot parts of the product.

A damaged power cable must be replaced by a qualified electrician. Otherwise, there is risk of electric shock, short circuit or fire!

Connection must comply with national regulations.

The mains supply data must correspond to the data specified on the type label of the product. Open the front door to see the type label.

Power cable of your product must comply with the values in "Technical specifications" table.

**DANGER:**

Before starting any work on the electrical installation, disconnect the product from the mains supply.

There is the risk of electric shock!

Connecting the power cable

1. If a power cable is not supplied together with your product, a power cable that you would select from the table in accordance with the electrical installation at your home must be connected to your product by following the instructions in cable diagram. This product must only be connected by a qualified electrician such as a technician from the local electricity company or NICEIC registered contractor to a suitable double-pole control unit with a minimum contact clearance of 3 mm in all poles. This control unit must be installed accordance with the IEE regulation. Failure to obey this instruction may cause operational problems and invalidate the product warranty.



Additional protection by a residual current circuit breaker is recommended.

2. Open the terminal block cover with a screwdriver.
3. Insert the power cable through the cable clamp below the terminal and secure it to the main body with the integrated screw on cable clamping component.
4. Connect the cables according to the supplied diagram.

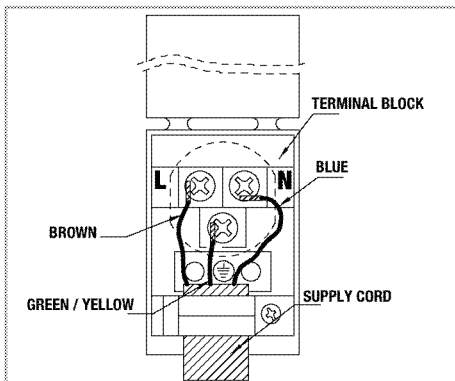

5. After completing the wire connections, close the terminal block cover.

6. Route the power cable so that it will not contact the product and get squeezed between the product and the wall.



Power cable must not be longer than 2 m because of safety reasons.

Installing the product

1. Slide the oven into the cabinet, align and secure it while making sure that the power cable is not broken and/or trapped.

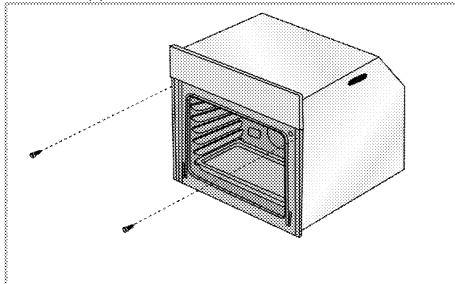

Secure the oven with 2 screws as illustrated.

For products with cooling fan (It may not exist on your product.)

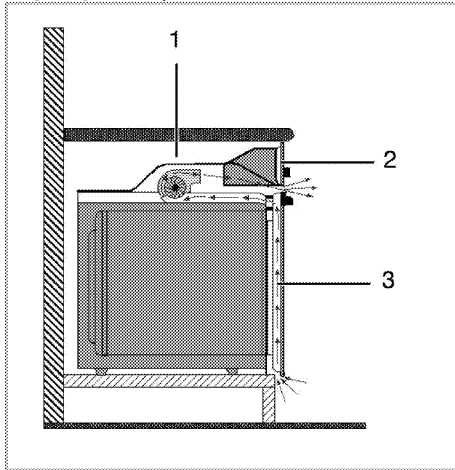

- 1 Cooling fan
- 2 Control panel
- 3 Door

The built-in cooling fan cools both the built-in cabinet and the front of the product.



Cooling fan continues to operate for about 20-30 minutes after the oven is switched off. If you have cooked by programming the timer of the oven, cooling fan will also be switched off at the end of the cooking time together with all functions.

Final check

1. Connect the power cable and switch on the product's fuse.
2. Check the functions.

Future Transportation

Keep the product's original carton and transport the product in it. Follow the instructions on the carton. If you do not have the original carton, pack the product in bubble wrap or thick cardboard and tape it securely. To prevent the wire grill and tray inside the oven from damaging the oven door, place a strip of cardboard onto the inside of the oven door that lines up with the position of the trays. Tape the oven door to the side walls.

Do not use the door or handle to lift or move the product.



Do not place any objects onto the product and move it in upright position.



Check the general appearance of your product for any damages that might have occurred during transportation.

4 Preparation

Tips for saving energy

The following information will help you to use your appliance in an ecological way, and to save energy: Use dark coloured or enamel coated cookware in the oven since the heat transmission will be better. While cooking your dishes, perform a preheating operation if it is advised in the user manual or cooking instructions. Do not open the door of the oven frequently during cooking.

Try to cook more than one dish in the oven at the same time whenever possible. You can cook by placing two cooking vessels onto the wire shelf. Cook more than one dish one after another. The oven will already be hot. You can save energy by switching off your oven a few minutes before the end of the cooking time. Do not open the oven door. Defrost frozen dishes before cooking them.

Initial use

Initial time setting

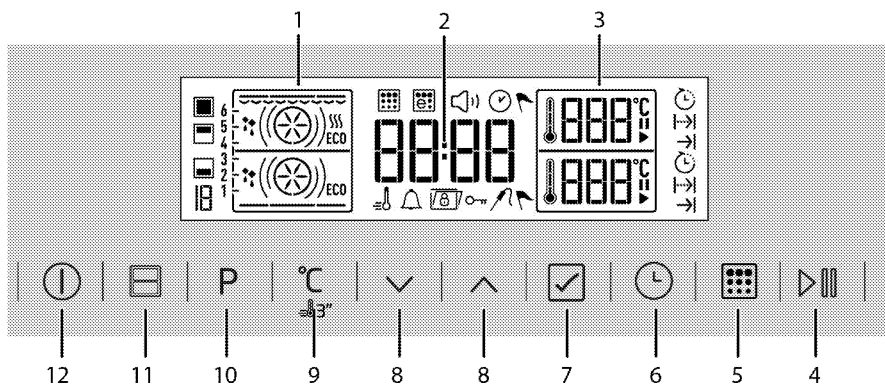

- 1 Function display
 - 2 Current time indicator field
 - 3 Temperature indicator field
 - 4 Start/stop cooking key
 - 5 Pyro key*
 - 6 Time and settings key
 - 7 Confirmation key
 - 8 Up/down keys
 - 9 Temperature/booster setting key
 - 10 Function selection key
 - 11 Oven section selection key
 - 12 ON/OFF key
- * (Varies depending on the product model.)

2. Set the hour with .
3. Touch to confirm the hour field.
4. Minute field and symbol will flash. Set the minute with . Touch to confirm the minute.

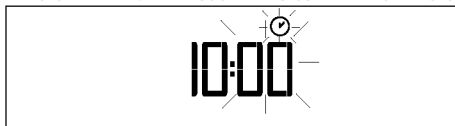

» It returns to the stand-by display. Only the current time appears on the display.



The time setting menu is displayed again in case of a long power failure.



First cleaning of the appliance



The surface might get damaged by some detergents or cleaning materials. Do not use aggressive detergents, cleaning powders/creams or any sharp objects during cleaning.

Do not use harsh abrasive cleaners or sharp metal scrapers to clean the oven door glass since they can scratch the surface, which may result in shattering of the glass.

1. Remove all packaging materials.
2. Wipe the surfaces of the appliance with a damp cloth or sponge and dry with a cloth.

Initial heating

Heat up the product for about 30 minutes and then switch it off. Thus, any production residues or layers will be burnt off and removed.



WARNING

Hot surfaces cause burns!

Product may be hot when it is in use. Never touch the hot burners, inner sections of the oven, heaters and etc. Keep children away. Always use heat resistant oven gloves when putting in or removing dishes into/from the hot oven.

Electric oven

1. Take all baking trays and the wire grill out of the oven.
2. Close the oven door.
3. Select Static position.

Grill oven

1. Take all baking trays and the wire grill out of the oven.
2. Close the oven door.
3. Select the highest grill power; see .
4. Operate the grill about 30 minutes.
5. Turn off your grill; see



Smoke and smell may emit for a couple of hours during the initial operation. This is quite normal. Ensure that the room is well ventilated to remove the smoke and smell. Avoid directly inhaling the smoke and the smell that emits.

5 How to operate the oven

General information on baking, roasting and grilling



WARNING

Hot surfaces cause burns!
Product may be hot when it is in use. Never touch the hot burners, inner sections of the oven, heaters and etc. Keep children away. Always use heat resistant oven gloves when putting in or removing dishes into/from the hot oven.



DANGER:

Be careful when opening the oven door as steam may escape.
Exiting steam can scald your hands, face and/or eyes.

Tips for baking

Use non-sticky coated appropriate metal plates or aluminum vessels or heat-resistant silicone moulds. Make best use of the space on the rack. Place the baking mould in the middle of the shelf. Select the correct rack position before turning the oven or grill on. Do not change the rack position when the oven is hot. Keep the oven door closed.

Tips for roasting

Treating whole chicken, turkey and large piece of meat with dressings such as lemon juice and black pepper before cooking will increase the cooking performance. It takes about 15 to 30 minutes longer to roast meat with bones when compared to roasting the same size of meat without bones.

Each centimeter of meat thickness requires approximately 4 to 5 minutes of cooking time. Let meat rest in the oven for about 10 minutes after the cooking time is over. The juice is better distributed all over the roast and does not run out when the meat is cut.

Fish should be placed on the middle or lower rack in a heat-resistant plate.

Tips for grilling

When meat, fish and poultry are grilled, they quickly get brown, have a nice crust and do not get dry. Flat pieces, meat skewers and sausages are particularly suited for grilling as are vegetables with high water content such as tomatoes and onions.

Distribute the pieces to be grilled on the wire shelf or in the baking tray with wire shelf in such a way that

the space covered does not exceed the size of the heater.

Slide the wire shelf or baking tray with grill into the desired level in the oven. If you are grilling on the wire shelf, slide the baking tray to the lower rack to collect fats. Add some water in the tray for easy cleaning.



Foods that are not suitable for grilling carry the risk of fire. Only grill food which is suitable for intensive grilling heat.

Do not place the food too far in the back of the grill. This is the hottest area and fatty food may catch fire.



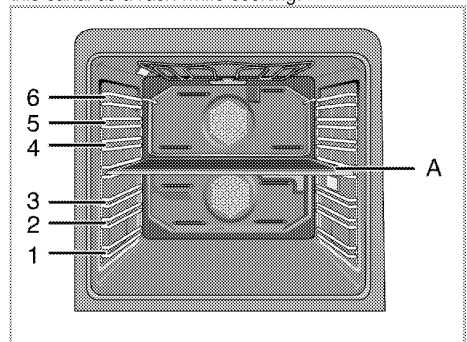

How to operate the electric oven

Rack positions

There are 6 racks suitable for use in your oven, 3 of which are in lower section and 3 of which are in upper section. There is another rack guide in the gap where middle section vessel plate (A) will be installed. Do not use this canal as a rack while cooking.



You can cook in 4 different sections of your oven.

	<p>Upper section</p>	<p>You can only cook in upper section. It is suitable for grill and small sized cookings.</p>	<p>When upper section is active, temperature value, rack positions, cooking symbol, stand-by symbol, cooking time symbol and cooking end time symbol of this section appear on the display.</p>
	<p>Lower section</p>	<p>You can only cook in lower section. It is suitable for medium sized cookings.</p>	<p>When upper section is active, temperature value, rack positions, cooking symbol, stand-by symbol, cooking time symbol and cooking end time symbol of this section appear on the display.</p>
	<p>Lower-upper sections</p>	<p>You can cook simultaneously in lower and upper sections. It is suitable for cooking two different dishes.</p>	<p>When lower-upper sections are active, temperature value, rack positions, cooking symbol, stand-by symbol, cooking time symbol and cooking end time symbol of these sections appear on the display separately.</p>
	<p>Single large section</p>	<p>You can cook in the single large section. It is suitable for large sized and multiple cookings.</p>	<p>When single large section is active, temperature value, rack positions, cooking symbol, stand-by symbol, cooking time symbol and cooking end time symbol of this section appear on the display.</p>





Oven functions

The order of operating modes shown here may be different from the arrangement on your product. These functions apply to oven with a single large section only.

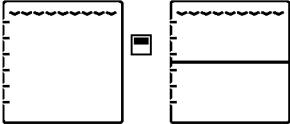
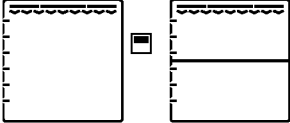
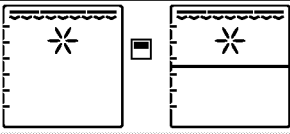
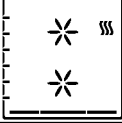
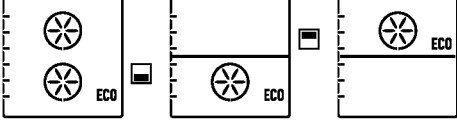
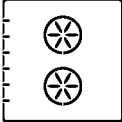
All oven functions of your oven are explained in this section.

Symbol	Name	Description
	Static (Top and bottom heating)	Top and bottom heaters are in operation simultaneously. Cook with one tray only.
	Bottom heating	Only bottom heater is in operation. It is suitable for pizza and for subsequent browning of food from the bottom.
	Static+fán (Fan supported bottom/top heating)	Top heater, bottom heater plus fan (in the rear wall) are in operation. Hot air is evenly distributed throughout the oven rapidly by means of the fan. Cook with one tray only.
	Defrost (Fan operated)	The oven is not heated. Only the fan (in the rear wall) is in operation. Suitable for thawing frozen granular food slowly at room temperature and cooling down the cooked food.
	Fán assisted cooking	Only the fan heater in the rear wall is in operation. Hot air heated by the fan heater is evenly distributed throughout the oven rapidly by means of the fan. In most cases, preheating is not required.
	Top heater+fán (Fán assisted top heating)	Top heater and the fan at the rear wall are in operation. Hot air is distributed better with fan compared to the situation where only top heating is in operation.
	Pizza	Bottom heater and the fan assisted heater (at the rear wall) are in operation simultaneously. Suitable for baking pizza.
	Multi "3D" cooking	Top heater, bottom heater and the fan assisted heater are in operation simultaneously. Cook with one tray only.

	Economic grill	Only the inner section of the top heater at oven ceiling operates. Suitable for grilling small and medium sizes of meat.
	Full grill	Inner and outer sections of the top heater at oven ceiling are in operation simultaneously. Suitable for grilling medium size meat pieces.
	Grill + Fan (Fan supported grill)	Rear wall fan operates along with the inner and outer sections of the top heater at oven ceiling. Hot air is evenly distributed throughout the oven rapidly by means of the fan. Suitable for grilling medium size meat pieces.
	Warm keeping	Used for keeping food at a temperature ready for serving for a long period of time. Do not use for cooking food.
	Eco fan cooking	Only the fan heater in the rear wall is in operation. To save power, you can use this function instead of the cooking operations that you would perform by using Fan Heating at 160-220oC temperature range. But, the cooking time will increase a little bit. Cooking times related to this function are indicated in "Eco Fan Cooking" table.
	Low temperature cooking	Used for cooking at low temperatures in longer times (10-15 hours).

Upper section 	Fan heating Economic fan Top heater+fan Full grill+Fan Full grill Defrost Economic grill
Lower section 	Fan heating Economic fan Defrost Bottom heating Pizza
Lower-upper section 	Fan assisted+Fan assisted Full grill+Fan assisted Defrost+Defrost Economic grill+Fan assisted Fan assisted+Bottom heater Fan assisted+Pizza
Single large section 	Static Static+fan Fan heating Multi cooking (3D) Pizza Top heater+fan Full grill+Fan Full grill Economic grill Economic fan Bottom heating Warm keeping Low temperature cooking Defrost

Function table

Function table indicates the functions that can be used in the oven and their respective maximum and minimum temperatures.

 Functions vary depending on the product model.

 While making any adjustment, related symbols will flash on the display.

 Program will be canceled in case of power failure. You must reprogram the oven.

 Current time cannot be set while the oven is operating in any function, or if semi-automatic or full automatic programming is made on the oven.

 Even if the oven is switched off, oven lamp lights up when the oven door is opened.

 Due to safety reasons, maximum time that can be set for "Cooking time" is limited with 6 hours at all positions apart from "Warm Keeping" and "Low Temp. Cooking" functions.

 Due to safety reasons, maximum time that can be set for "Cooking time" is limited with 6 hours at all positions apart from "Warm Keeping" and "Low Temp. Cooking" functions.

Single large section

Function	Recommended temperature (°C)	Temperature range (°C)
Static	200	40-280
Static + fan	175	40-280
Fan heating	180	40-250
Multi cooking (3D)	205	40-250
Pizza	210	40-280
Top heater+fan	200	40-280
Full grill+Fan	200	40-280
Full grill	280	40-280
Economic grill	280	40-280
Economic fan	180	160-220
Bottom heating	180	40-220
Warm keeping	60	40-100
Low temperature cooking	100	50-150
Defrost	-	-

Upper section

Function	Recommended temperature (°C)	Temperature range (°C)
Fan heating	180	40-250
Top heater+fan	200	40-280
Full grill+Fan	200	40-280
Full grill	280	40-280

Economic grill	280	40-280
Economic fan	180	160-220
Defrost	-	-

Economic fan	180	160-220
Bottom heating	180	40-220
Defrost	-	-

Lower section

Function	Recommended temperature (°C)	Temperature range (°C)
Fan heating	180	40-250
Pizza	210	40-280

How to operate the oven control unit

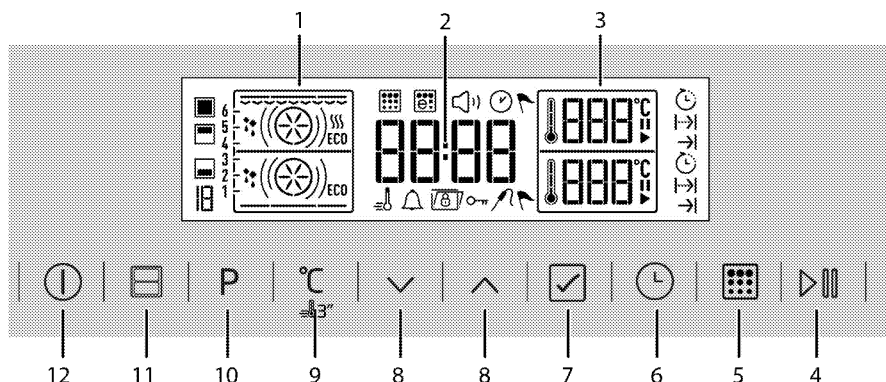

- 1 Function display
 - 2 Current time indicator field
 - 3 Temperature indicator field
 - 4 Start/stop cooking key
 - 5 Pyro key*
 - 6 Time and settings key
 - 7 Confirmation key
 - 8 Up/down keys
 - 9 Temperature/booster setting key
 - 10 Function selection key
 - 11 Oven section selection key
 - 12 ON/OFF key
- * (Varies depending on the product model.)

Display symbols:

- Rapid heating (Booster) symbol
- Cooking duration symbol
- Cooking duration end symbol
- Alarm symbol
- Section selection symbol
- Cooking symbol
- Current time symbol
- Stopped symbol

- Keep warm symbol
 - Defrost symbol
 - Key lock symbol
 - Time display symbol
 - Volume setting symbol
 - Self cleaning (pyro) symbol*
 - Economical self cleaning (ecopyro) symbol*
 - Meat probe symbol *
- * Varies depending on the product model.

Operating the oven as a single section



Manual cooking by selecting temperature and operating function

During manual operation, the oven will operate regardless of the cooking time after the function and temperature selection is made. The oven will not switch off automatically at the end of the cooking time. Cooking should be ended by the user.

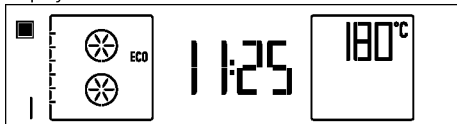

Oven returns to stand-by display after it is powered on for the first time and the current time is set. Only the current time appears on the display.

1. Remove the middle section plate from the oven. Only after the middle section plate is removed the oven timer will work in single large section cooking setting.
2. Switch on the oven touching the  key for two seconds.
3. When the oven is switched on, the first function peculiar to the single large section cooking will be displayed.



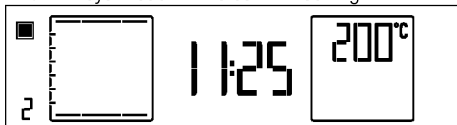



4. Touch  to enter the display for setting the operating function.
 - » The relevant function number will flash on the display.
5. Set the desired cooking function touching the  keys. Touch  to confirm setting.

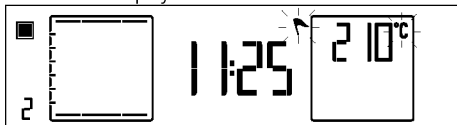







6. If you want to change the temperature, touch  once to reach the temperature display.  and  will flash on the display.



7. Touch  to set the desired temperature. When the desired value is reached, touch  to confirm temperature.
8. For Booster (Rapid Heating), touch  for approximately 3 seconds until  appears on the display.  will appear and the booster setting will be activated.



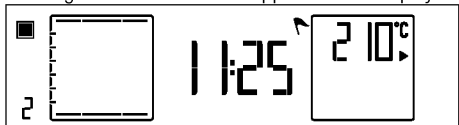

 When the booster setting is made, the oven operates in maximum power to reach the set temperature. When the set temperature is reached  will disappear. Booster setting is active for the functions during which  is displayed when  is touched for a long time. Booster can only be activated for cooking operations performed in the single large section.

9. Put your dish into the oven and close the door.
10. If cooking function and temperature values are suitable, touch  for two seconds to start cooking. Cooking will start and  will appear on the display.



» Oven will heat up to the adjusted temperature.

 All segments of the inner oven temperature  symbol will turn on when the oven reaches the set temperature.

11. When the cooking process is completed touch  key again for two seconds to end the cooking.

Cooking by setting the cooking time;

You can make your oven switch off automatically at the end of cooking time by selecting the temperature and function specific to your meal and setting the cooking time.

Oven returns to stand-by display after it is powered on for the first time and the current time is set. Only the current time appears on the display.

1. Remove the middle section plate from the oven. Only after the middle section plate is removed the oven timer will work in single large section cooking setting.
2. Switch on the oven touching the  key for two seconds.
3. When the oven is switched on, the first function peculiar to the single large section cooking will be displayed.

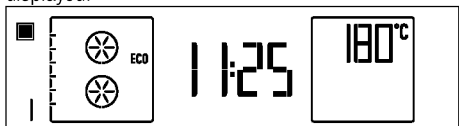



4. Touch  to enter the display for setting the operating function.
 - » The relevant function number will flash on the display.

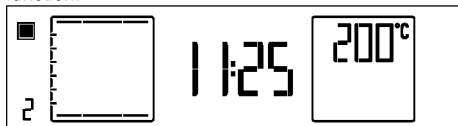

5. Touch  to set the desired operating function.

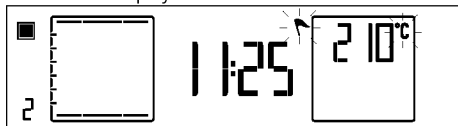





6. If you want to change the temperature, touch $^{\circ}\text{C}$ once to reach the temperature display. $^{\circ}\text{C}$ symbol will flash on the display.



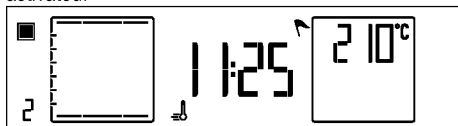

7. Touch  to set the desired temperature. When the desired value is reached, touch  to confirm temperature.





8. For Booster (Rapid Heating), touch $^{\circ}\text{C}$ for approximately 3 seconds until  appears on the display.  will appear and the booster setting will be activated.





 When the booster setting is made, the oven operates in maximum power to reach the set temperature. When the set temperature is reached  will disappear. Booster setting is active for the functions during which  is displayed when $^{\circ}\text{C}$ is touched for a long time. Booster can only be activated for cooking operations performed in the single large section.

9. Touch  once for cooking time.  will flash on the display.





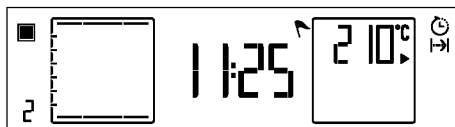

10. Touch  to set the desired cooking time and confirm the setting by touching . Once the cooking time is set,  and  will remain lit on the display.

11. Put your dish into the oven and close the door.
12. If cooking function, temperature and time values are suitable, touch  for 2 seconds to start cooking. Cooking will start and  will appear on the display.





» Your oven will readily start operating in the selected function and will increase the inner temperature to the set temperature. It maintains this temperature until the end of the set cooking time. Each grade of the inner temperature symbol will be lit as inner temperature reaches to the set temperature. Additional active heaters and recommended tray position appear in the Function display.

 All segments of the inner oven temperature symbol  will turn on when the oven reaches the set temperature.

13. After the cooking is completed,  and  will flash on the display and an alarm signal will be heard.

14. To stop the alarm signal, just touch any key. The oven will switch off automatically.

15. If you want the oven to continue operating, press  for 2 seconds. The oven will continue cooking for an indefinite period of time.

 If you want to cancel the setting after performing the cooking setting by adjusting the cooking time, you will need to reset the cooking time. You can also switch off the oven by touching  if you want.

Setting the end of cooking time to a later time;

You can ensure that the oven runs and turns off automatically by setting temperature and operating function specific to your meal, the cooking time and end of cooking to a later time, manually controlling without setting the cooking time.

Oven returns to stand-by display after it is powered on for the first time and the current time is set. Only the current time appears on the display.

1. Remove the middle section plate from the oven. Only after the middle section plate is removed the oven timer will work in single large section cooking setting.
2. Switch on the oven touching the  key for two seconds.
3. When the oven is switched on, the first function peculiar to the single large section cooking will be displayed.

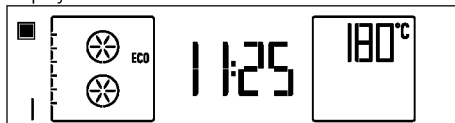

4. Touch **P** to enter the display for setting the operating function.

» The relevant function number will flash on the display.

5. Touch **^** to set the desired operating function.

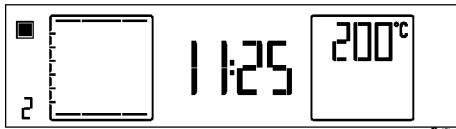

6. If you want to change the temperature, touch **°C** once to reach the temperature display. **°C** symbol will flash on the display.



7. Touch **^** to set the desired temperature. When the desired value is reached, touch **✓** to confirm temperature.

8. For Booster (Rapid Heating), touch **°C** for approximately 3 seconds until **≡** appears on the display. **≡** will appear and the booster setting will be activated.



i When the booster setting is made, the oven operates in maximum power to reach the set temperature. When the set temperature is reached **≡** will disappear. Booster setting is active for the functions during which **≡** is displayed when **°C** is touched for a long time. Booster can only be activated for cooking operations performed in the single large section.

9. Touch **⌚** once for cooking time. **⌚** will flash on the display.



10. Touch **^** to set the desired cooking time and confirm the setting by touching **✓**. Once the cooking time is set, **⌚** and **⌚** will remain lit on the display.

11. Touch **⌚** twice at short intervals for the end of cooking time. **→** will flash on the display.



12. Touch **^** to set the desired end of cooking time and confirm the setting by touching **✓**. Once the end of cooking time is set, **→** will be displayed continuously.

13. Put your dish into the oven and close the door.

14. If cooking function, temperature, time and end time values are suitable, touch **▷** for 2 seconds to start cooking.



» **⌚** will appear on the display. Oven timer automatically calculates the startup time for cooking by deducting the cooking time from the end of cooking time you have set. When the cooking startup time comes, the selected cooking function will be activated, **→** will disappear and the oven will heat up to the set temperature. It will maintain this temperature until the end of the set cooking time. Each grade of the inner temperature symbol will be lit as inner temperature reaches to the set temperature. Additional active heaters and recommended tray position appear in the Function display. The oven lamp is lit during the cooking process.

i All segments of the inner oven temperature symbol **↓** will turn on when the oven reaches the set temperature.

15. After the cooking is completed, **⌚** and **⌚** will flash on the display and an alarm signal will be heard.

16. To stop the alarm signal, just touch any key. The oven will switch off automatically.

17. If you want the oven to continue operating, press **▷** for 2 seconds. The oven will continue cooking for an indefinite period of time.

i If you want to cancel the programme after performing the cooking setting by adjusting the cooking time, you will need to reset the cooking time. You can also switch off the oven by touching **⌚** if you want.

Using the oven only as the top or bottom section

Manual cooking by selecting temperature and operating function

During manual operation, the oven will operate regardless of the cooking time after the function and temperature selection is made. The oven will not switch off automatically at the end of the cooking time. Cooking should be ended by the user.

Oven returns to stand-by display after it is powered on for the first time and the current time is set. Only the current time appears on the display.

1. Place the middle section plate in its housing found between the 3rd and 4th rack guides.



If the middle section plate is not placed, the oven timer will operate as a whole single section.

2. Switch on the oven touching the  key for two seconds.

3. When the oven is switched on, the first function special to the top section cooking will be displayed.



4. Touch  once to activate the bottom section of oven.

Temperature setting and cooking process initiation steps for both bottom and top oven sections will iterate in the same way. (In the images, the bottom oven is shown as selected.)

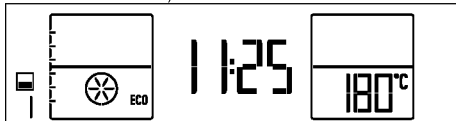

Each time you touch , the bottom section only, both bottom and top sections and the top section only will be activated respectively.

5. Touch  to enter the display for setting the operating function.

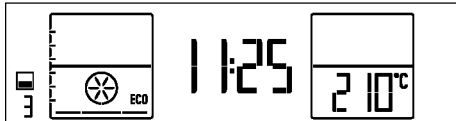

» The relevant function number will flash on the display.

6. Touch  to set the desired operating function.





7. If you want to change the temperature, touch $^{\circ}\text{C}$ once to reach the temperature display. $^{\circ}\text{C}$ symbol will flash on the display.



8. Touch  to set the desired temperature. When the desired value is reached, touch  to confirm temperature.

9. Put your dish into the oven and close the door.

10. If cooking function and temperature values are suitable, touch  for two seconds to start cooking. Cooking will start and  will appear on the display.

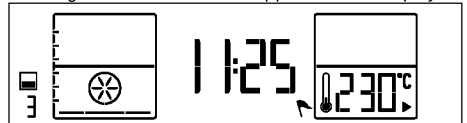

» Oven will heat up to the adjusted temperature.



All segments of the inner oven temperature symbol  will turn on when the oven reaches the set temperature.

11. When the cooking process is completed touch  again for two seconds to end the cooking.

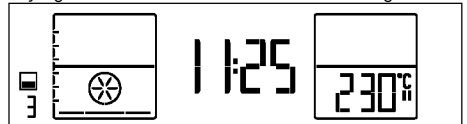

When using only the top or bottom section for cooking, keep the unused section empty as it will get hot.

Cooking by setting the cooking time;

You can make your oven switch off automatically at the end of cooking time by selecting the temperature and function specific to your meal and setting the cooking time.

Oven returns to stand-by display after it is powered on for the first time and the current time is set. Only the current time appears on the display.

1. Place the middle section plate in its housing found between the 3rd and 4th rack guides.



If the middle section plate is not placed, the oven timer will operate as a whole single section.

2. Switch on the oven touching the  key for two seconds.

3. When the oven is switched on, the first function special to the top section cooking will be displayed.

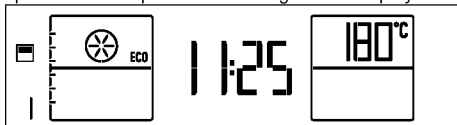

4. Touch once to activate the bottom section of oven.

Temperature setting and cooking process initiation steps for both bottom and top oven sections will iterate in the same way. (In the images, the bottom oven is shown as selected.)



i Each time you touch , the bottom section only, both bottom and top sections and the top section only will be activated respectively.

5. Touch **P** to enter the display for setting the operating function.

» The relevant function number will flash on the display.

6. Touch to set the desired operating function.

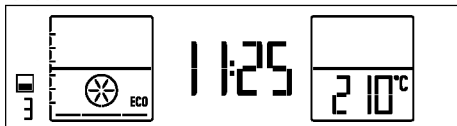

7. If you want to change the temperature, touch $^{\circ}\text{C}$ once to reach the temperature display. $^{\circ}\text{C}$ symbol will flash on the display.

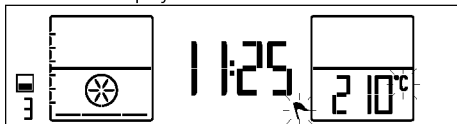

8. Touch to set the desired temperature. When the desired value is reached, touch to confirm temperature.

9. For cooking time, press once to scroll to the "Cooking time" on the text display. will flash at the same time.

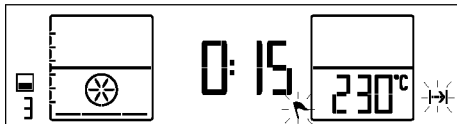

10. Touch to set the desired cooking time and confirm the setting by touching . Once the cooking time is set, and will remain lit on the display.

11. Put your dish into the oven and close the door.

12. If cooking function, temperature and time values are suitable, touch for 2 seconds to start cooking. Cooking will start and will appear on the display.

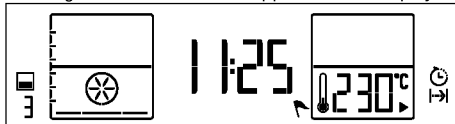

» Your oven will readily start operating in the selected function and will increase the inner temperature to the set temperature. It will maintain this temperature until the end of the set cooking time. Each grade of the inner temperature symbol will be lit as inner temperature reaches to the set temperature. Additional active heaters and recommended tray position appear in the Function display.

i All segments of the inner oven temperature symbol will turn on when the oven reaches the set temperature.

13. After the cooking is completed, and will flash on the display and an alarm signal will be heard.

14. To stop the alarm signal, just touch any key. The oven will switch off automatically.

15. If you want the oven to continue operating, press for 2 seconds. The oven will continue cooking for an indefinite period of time.

i If you want to cancel the setting after performing the cooking setting by adjusting the cooking time, you will need to reset the cooking time. You can also switch off the oven by touching if you want.

Setting the end of cooking time to a later time;

You can ensure that the oven runs and turns off automatically by setting temperature and operating function specific to your meal, the cooking time and end of cooking to a later time, manually controlling without setting the cooking time.



Oven returns to stand-by display after it is powered on for the first time and the current time is set. Only the current time appears on the display.

1. Place the middle section plate in its housing found between the 3rd and 4th rack guides.

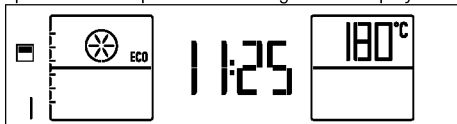

i If the middle section plate is not placed, the oven timer will operate as a whole single section.



- Switch on the oven touching the  key for two seconds.
- When the oven is switched on, the first function special to the top section cooking will be displayed.

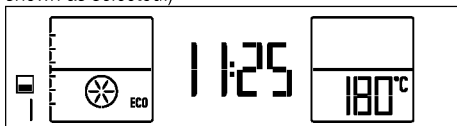



- Touch  once to activate the bottom section of oven.
 will appear next to the active oven section. Temperature setting and cooking process initiation steps for both bottom and top oven sections will iterate in the same way. (In the images, the bottom oven is shown as selected.)





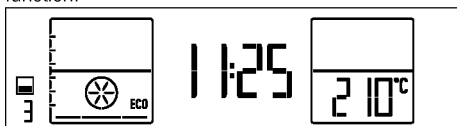

 Each time you touch , the bottom section only, both bottom and top sections and the top section only will be activated respectively.

- Touch  to enter the display for setting the operating function.
 » The relevant function number will flash on the display.
- Touch  to set the desired operating function.







- If you want to change the temperature, touch  once to reach the temperature display.  symbol will flash on the display.

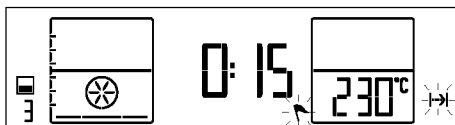







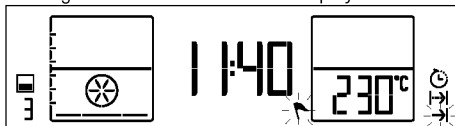

- Touch  to set the desired temperature. When the desired value is reached, touch  to confirm temperature.
- Touch  once for coking time.  will flash on the display.







- Touch  to set the desired cooking time and confirm the setting by touching . Once the cooking time is set,  will be displayed continuously.
- Touch  twice at short intervals for the end of cooking time.  will flash on the display.



- Touch  to set the desired end of cooking time and confirm the setting by touching . Once the end of cooking time is set,  will be displayed continuously.
- Put your dish into the oven and close the door.
- If cooking function, temperature, time and end time values are suitable, touch  for 2 seconds to start cooking.
 » »  will appear on the display. Oven timer automatically calculates the startup time for cooking by deducting the cooking time from the end of cooking time you have set. When the cooking startup time comes, the selected cooking function will be activated,  will disappear and the oven will heat up to the set temperature. It will maintain this temperature until the end of the set cooking time. Each grade of the inner temperature symbol will be lit as inner temperature reaches to the set temperature. Additional active heaters and recommended tray position appear in the Function display. The oven lamp is lit during the cooking process.

 All segments of the inner oven temperature  will turn on when the oven reaches the set temperature.

- After the cooking is completed,  and  will flash on the display and an alarm signal will be heard.
- To stop the alarm signal, just touch any key. The oven will switch off automatically.
- If you want the oven to continue operating, press  for 2 seconds. The oven will continue cooking for an indefinite period of time.

i If you want to cancel the programme after performing the cooking setting by adjusting the cooking time, you will need to reset the cooking time. You can also switch off the oven by touching  if you want.

Using the top and bottom sections of the oven simultaneously

Manual cooking by selecting temperature and operating function

During manual operation, the oven will operate regardless of the cooking time after the function and temperature selection is made. The oven will not switch off automatically at the end of the cooking time. Cooking should be ended by the user.

Oven returns to stand-by display after it is powered on for the first time and the current time is set. Only the current time appears on the display.

1. Place the middle section plate in its housing found between the 3rd and 4th rack guides.

i If the middle section plate is not placed, the oven timer will operate as a whole single section.

2. Switch on the oven touching the  key for two seconds.

3. When the oven is switched on, the first function special to the top section cooking will be displayed.

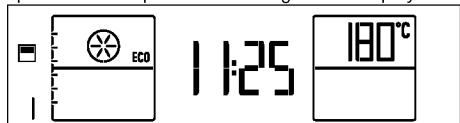

i Each time you touch  the bottom section only, both bottom and top sections and the top section only will be activated respectively.

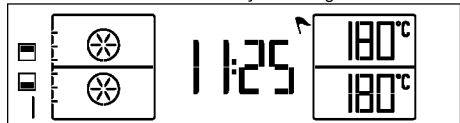

4. Activate both sections by touching  twice.







5. Touch  to enter the display for setting the operating function.

» The relevant function number will flash on the display.

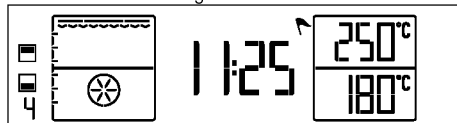
6. Touch the  to select the appropriate cooking function amongst the ones adjusted for both oven sections. For example, to make grill in the top and cook pastry in the bottom section you can select Grill & Fan supported function.

After the function is selected, "Temperature" and "Cooking time" can be adjusted separately for each oven section.  and  symbols of the active cooking sections for this settings will flash.



7. If you want to change the temperature of top oven, touch  once to access the temperature display of top oven.  and  will flash on the temperature display of the selected oven section.

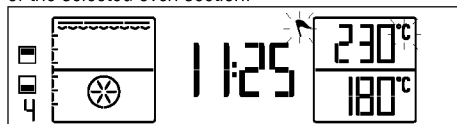



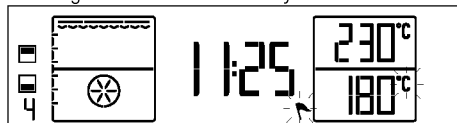

8. Touch  to set the desired temperature.

When you reach the desired value, confirm the temperature by touching .  will lid steadily and  symbol of the active cooking section will flash.

9. To change the temperature of the bottom oven, activate the bottom oven's temperature display touching . Bottom oven's  symbol will flash.





10. Touch  once to access the temperature display of bottom oven.  and  will flash on the temperature display of the selected oven section.

11. Touch  to set the desired temperature.

When you reach the desired value, confirm the temperature by touching .  will lid steadily and  symbol of the active cooking section will flash.

i While using the top and bottom sections simultaneously, if you want to change temperature setting, the difference between the sections cannot be more than 80 °C. Because the sections will be affected from each others temperature.

12. Put your dish into the oven and close the door.

13. If cooking function and temperature values are suitable, touch  for two seconds to start cooking. Cooking will start and  and  will appear on the display of the top and bottom oven sections.

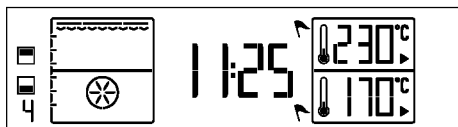

i All segments of the inner oven temperature symbol will turn on when the oven reaches the set temperature.

14. When the cooking process is completed touch key again for two seconds to end the cooking.

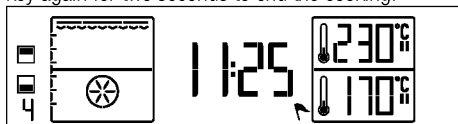

Cooking by setting the cooking time; Semi-automatic operation

You can make your oven switch off automatically at the end of cooking time by selecting the temperature and function specific to your meal and setting the cooking time.

Oven returns to stand-by display after it is powered on for the first time and the current time is set. Only the current time appears on the display.

1. Place the middle section plate in its housing found between the 3rd and 4th rack guides.

i If the middle section plate is not placed, the oven timer will operate as a whole single section.

2. Switch on the oven touching the key for two seconds.

3. When the oven is switched on, the first function special to the top section cooking will be displayed.

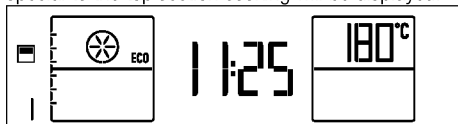

i Each time you touch the bottom section only, both bottom and top sections and the top section only will be activated respectively.

4. Activate both sections by touching twice. will appear next to each oven section.

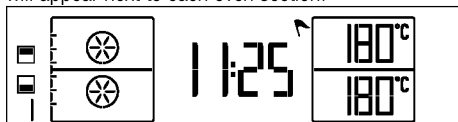

5. Touch to enter the display for setting the operating function.

» The relevant function number will flash on the display.

6. Touch to select the appropriate cooking function amongst the ones adjusted for both oven sections. For example, to make grill in the top and cook pastry in the bottom section you can select Grill & Fan supported function.

After the function is selected, "Temperature" and "Cooking time" can be adjusted separately for each oven section. For these settings symbol of the active cooking section will flash.

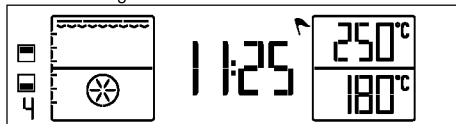

7. If you want to change the temperature of top oven, touch once to access the temperature display of top oven. symbol will flash on the temperature display of the selected oven section.

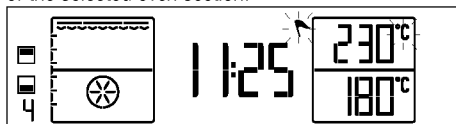

8. Touch to set the desired temperature.

When you reach the desired value, confirm the temperature by touching . will lid steadily and symbol of the active cooking section will flash.

9. To change the temperature of the bottom oven, activate the bottom oven's temperature display by touching . Bottom oven's symbol will flash.

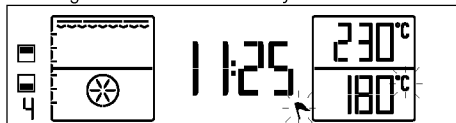



10. Touch once to access the temperature display of bottom oven. symbol will flash on the temperature display of the selected oven section.



11. Touch to set the desired temperature.





When you reach the desired value, confirm the temperature by touching . symbol of the active cooking section will flash.

i While using the top and bottom sections simultaneously, if you want to change temperature setting, the difference between the sections cannot be more than 80 °C. Because the sections will be affected from each others temperature.



12. Touch  once for the cooking time of the active bottom section of the oven. At the same time,  will flash.

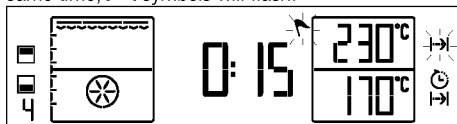

13. Touch  to set the desired cooking time and confirm the setting by touching . Once the cooking time is set,  will be displayed on the screen continuously.

14. For the cooking time of the other top section, first activate the section by touching .  symbol of the top section will flash. Then, touch  once. At the same time,  symbols will flash.







15. Set the desired cooking time for the top section by touching  and confirm with . Once the cooking time of the top section is set,  will be displayed on the screen continuously.

16. Put your dish into the oven and close the door.

17. If cooking function, temperature and time values are suitable, touch  for 2 seconds to start cooking. Cooking will start and  will appear on the display.



» Your oven will readily start operating in the selected function and will increase the inner temperature to the set temperature. It will maintain this temperature until the end of the set cooking time. Each grade of the inner temperature symbol will be lit as inner temperature reaches to the set temperature. Additional active heaters and recommended tray position appear in the Function display.

 All segments of the inner oven temperature symbol  will turn on when the oven reaches the set temperature.

18. At the end of the short cooking time, a single signal will be heard and  and  symbols of the related oven section will disappear.



After the cooking is completed,  and  will flash on the display and an alarm signal will be heard.

19. Take the meal out of the oven when cooking duration is over. When you close the oven door again, cooking in the other section with the longer cooking duration will continue.

20. Once the long cooking duration is complete, two signals will be heard and  and  symbols of the related oven section will flash.

21. Cooking will stop.

22. Touch  for two seconds if you want both sections of the oven to continue operating. The oven will continue cooking for an indefinite period of time.

 If you want to cancel the semi-automatic programming after you have set it, you need to reset the cooking duration. You can also switch off the oven by touching  for 2 seconds if you want.

Switching off the electric oven

Touch  for 2 seconds to switch off the oven.

Using the key lock

You can prevent oven from being intervened with by activating the key lock function.



 Key lock can be used when the oven is in stand-by. The set key lock will be cancelled in case of power failure.

Activating the key lock

1. Touch  key with short intervals until "OFF" appears on the display.





»  will flash.

2. Touch  key once to activate the key lock. The key lock will be activated, "On" will appear on the display.  will continue to flash.





3. Touch  to confirm the setting.

» The text will disappear and  will light continuously.

 Except for  keys, other oven keys are not functional when the key lock function is activated.

Deactivating the key lock

1. Touch  once to deactivate the key lock. "OFF" will appear on the display.

2. Touch  to confirm the setting.



» Key lock will be deactivated and  on the display will disappear.

Using the clock as an alarm

You can use the timer of the product for any warning or reminder apart from the cooking program. The alarm clock has no influence on the functions of the oven. It is only used as a warning. For example, this is useful when you want to turn food in the oven at a certain point of time. Alarm clock will give a signal once the time you set is over.





Maximum alarm time can be 23 hours and 59 minutes.



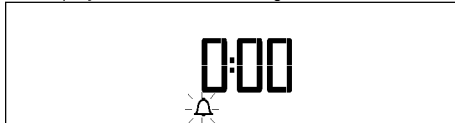

To set the alarm:

1. Touch  at short intervals until  appears on the display.  will start flashing.





2. Touch  to set the desired time and confirm the setting by touching . Once the alarm time is set,  will be displayed continuously.
3. Alarm will be given after the alarm time has elapsed.
4. You can stop the alarm by touching any key.

To cancel the alarm:



1. Touch  key at short intervals until  appears on the display.
 2. Touch  until "00:00" appears on the display and confirm the setting by touching .
- » Alarm will be cancelled and  symbol will disappear.

Sound setting

Sound can only be set when the oven is on stand-by display.

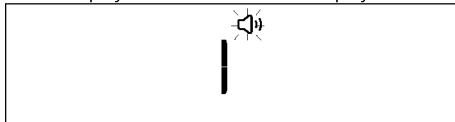

1. Touch  key at short intervals until  appears on the display.  will flash on the display.







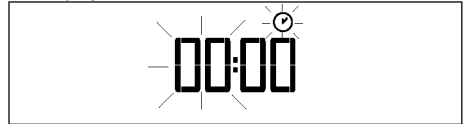

2. There are 2 sound types, namely "1" and "2". Touch  to select the desired type.
 3. Touch .
- » It returns to the stand-by display. Only the current time appears on the display.

Current time setting

Current time can only be set when the oven is switched off. If you want to change the time that was set during initial setup:

1. Touch  key at short intervals until  appears on the display. Hour field and  will symbol flash on the display.



2. Use  to set the hour field.
3. Touch  to confirm the setting.
4. Minute field and  symbol will flash. Set the minute with  keys. Touch  to confirm the minute.



» It returns to the stand-by display. Only the current time appears on the display.



Cooking times table



The timings in this chart are meant as a guide. Timings may vary due to temperature of food, thickness, type and your own preference of cooking.

For single large section Baking and roasting



When you open the oven door, if there are cooking tips available on the glass of the oven door these are applicable for the single whole section.













1st rack of the oven is the **bottom** rack.

Dish	Cooking level number	Operating mode	Rack position	Temperature (°C)	Cooking time (approx. in min.)
Cakes in tray*	One level		3	175	25 ... 35
Cakes in mould*	One level		2	180	40 ... 50
Cakes in cooking paper*	One level		3	175	20 ... 30
	2 levels		1 - 5	175	30 ... 40
	3 levels		1 - 3 - 5	170	35 ... 45
Sponge cake*	One level		3	200	5 ... 10
	2 levels		1 - 5	175	20 ... 30
Cookies*	One level		3	175	25 ... 30
	2 levels		1 - 5	170 ... 190	30 ... 40
	3 levels		1 - 3 - 5	175	35 ... 45
Dough pastry*	One level		2	200	30 ... 40
	2 levels		1 - 5	200	45 ... 55
	3 levels		1 - 3 - 5	200	55 ... 65
Rich pastry*	One level		2	200	25 ... 35
	2 levels		1 - 5	200	35 ... 45
	3 levels		1 - 3 - 5	190	45 ... 55
Leaven*	One level		2	200	35 ... 45
	2 levels		1 - 3	190	35 ... 45
Lasagna*	One level		2 - 3	200	30 ... 40
Pizza*	One level		2	200 ... 220	15 ... 20
	One level		3	200	10 ... 15
Beef steak (whole) / Roast	One level		3	25 min. 250/max then 180 ... 190	100 ... 120
Leg of Lamb (casserole)	One level		3	25 min. 250/max then 190	70 ... 90
	One level		3	25 min. 250/max then 190	70 ... 90
Roasted chicken	One level		2	15 min. 250/max then 180 ... 190	60 ... 70
	One level		2	15 min. 250/max then 180 ... 190	55 ... 65
Turkey (5.5 kg)	One level		1	25 min. 250/max then 180 ... 190	150 ... 210
	One level		1	25 min. 250/max then 180 ... 190	150 ... 210
Fish	One level		3	200	20 ... 30
	One level		3	200	20 ... 30

When cooking with 2 trays at the same time, place the deeper tray on the upper rack and the other one on the lower rack.







* It is suggested to perform preheating for all foods.

For bottom section only Baking and roasting

Dish	Cooking level number	Operating mode	Rack position	Temperature (°C)	Cooking time (approx. in min.)
Cakes in mould*	One level		1	175	40 ... 50
Cakes in cooking paper*	One level		2	175	25 ... 35
	2 levels		1 - 3	175	40 ... 45
Cookies*	One level		2	170 ... 180	35 ... 45
	2 levels		1 - 3	165	35 ... 40
Rich pastry*	One level		2	190	35 ... 45
Pizza*	One level		1	200	10 ... 15
Roasted chicken	One level		1	15 min. 250/max then 180 ... 190	55 ... 65
Turkey (Sliced)	One level		1	25 min. 250/max then 180 ... 190	150 ... 210
Fish	One level		2	200	20 ... 30

* It is suggested to perform preheating for all foods.

For top section only Baking and roasting

Dish	Cooking level number	Operating mode	Rack position	Temperature (°C)	Cooking time (approx. in min.)
Cakes in mould*	One level		4	175	40 ... 50
Cakes in cooking paper*	One level		4	175	40 ... 45
Cookies*	One level		4	170 ... 180	35 ... 45
Rich pastry*	One level		4	190	35 ... 45
Roasted chicken	One level		4	15 min. 250/max then 180 ... 190	55 ... 65
Turkey (Sliced)	One level		4	25 min. 250/max then 180 ... 190	150 ... 210
Fish	One level		5	200	20 ... 30

* It is suggested to perform preheating for all foods.





Eco Fan Heating



Do not change the cooking temperature after cooking starts in Eco Fan Heating mode.



Do not open the door during cooking in the Eco Fan Heating mode.

Dish	Cooking level number	Operating mode	Rack position	Temperature (°C)	Cooking time (approx. in min.)
Cakes in cooking paper	One level		3	200	35 ... 40
Cookies	One level		3	200	30 ... 35
Dough pastry	One level		3	200	40 ... 45
Rich pastry	One level		3	200	40 ... 45

Tips for baking cake

If the cake is too dry, increase the temperature some 10°C and decrease the cooking time.

If the cake is wet, use less liquid or lower the temperature by 10°C.

If the cake is too dark on top, place it on a lower rack, lower the temperature and increase the cooking time.

If cooked well on the inside but sticky on the outside use less liquid, lower the temperature and increase the cooking time.

Tips for baking pastry

If the pastry is too dry, increase the temperature some 10°C and decrease the cooking time. Dampen the layers of dough with a sauce composed of milk, oil, egg and yoghurt.

If the pastry takes too long to bake, pay care that the thickness of the pastry you have prepared does not exceed the depth of the tray.

If the upper side of the pastry gets browned, but the lower part is not cooked, make sure that the amount of sauce you have used for the pastry is not too much at the bottom of the pastry. Try to scatter the sauce

equally between the dough layers and on the top of pastry for an even browning.



Cook the pastry in accordance with the mode and temperature given in the cooking table. If the bottom part is still not browned enough, place it on one lower rack next time.

Tips for cooking vegetables

If the vegetable dish runs out of juice and gets too dry, cook it in a pan with a lid instead of a tray. Closed vessels will preserve the juice of the dish. If a vegetable dish does not get cooked, boil the vegetables beforehand or prepare them like canned food and put in the oven.

How to operate the grill



WARNING

Close oven door during grilling. Hot surfaces may cause burns!





Grilling can be made in single whole section, only top section or in the top section when bottom-top sections are operated.

Grilling in single large section

Oven returns to stand-by display after it is powered on for the first time and the current time is set. Only the current time appears on the display.

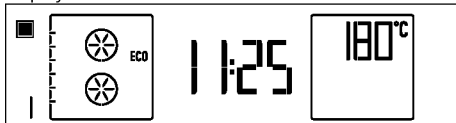
1. Remove the middle section plate from the oven. Only after the middle section plate is removed the oven timer will work in single large section cooking setting.
2. Switch on the oven touching  for two seconds.
3. When the oven is switched on, the first function peculiar to the single large section cooking will be displayed.



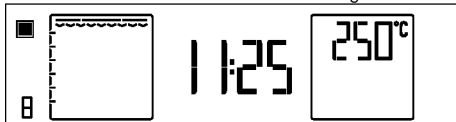

4. Touch  to enter the display for setting the operating function.
 - » The relevant function number will flash on the display.
5. Touch  to select the desired grill function.



6. After the function is selected "Temperature", "Rapid Heating (Booster)", "Cooking time" and "Cooking end time" can be set. see. (Operating the

oven as a single section) *How to operate the oven control unit, page 23*

7. If cooking function, temperature and time values are suitable, touch  key to start cooking. Cooking starts.
8. If the cooking time is set, the oven will automatically switch off at the end of this time. Two audible signals will be heard. If no cooking time is set, touch  again to end the cooking when the cooking process is complete.
9. Touch  key to switch off the oven.

Grilling in top section only mode

Oven returns to stand-by display after it is powered on for the first time and the current time is set. Only the current time appears on the display.

1. Place the middle section plate in its housing found between the 3rd and 4th rack guides.





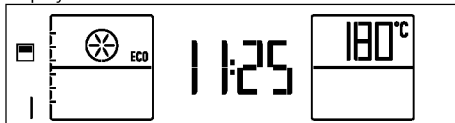

If the middle section plate is not placed, the oven timer will operate as a whole single section.

2. Switch on the oven touching  for two seconds.
3. When the oven is switched on, the first function peculiar to the single large section cooking will be displayed.

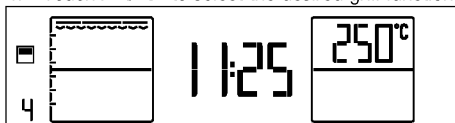

4. Touch  to select the desired grill function.



5. After the function is selected "Temperature", "Rapid Heating (Booster)", "Cooking time" and "Cooking end time" can be set. see. (Using the oven only as the top or bottom section) *How to operate the oven control unit, page 23*
6. If cooking function, temperature and time values are suitable, touch  key to start cooking. Cooking starts.
7. The oven will automatically switch off at the end of the cooking time, if set. Two audible signals will be heard. If no cooking time is set, touch  again to end the cooking when the cooking process is complete.
8. Touch  key to switch off the oven.

Grilling only in the top section while the top and bottom sections of the oven are in operation

Oven returns to stand-by display after it is powered on for the first time and the current time is set. Only the current time appears on the display.

1. Place the middle section plate in its housing found between the 3rd and 4th rack guides.





If the middle section plate is not placed, the oven timer will operate as a whole single section.

2. Switch on the oven touching  for two seconds.

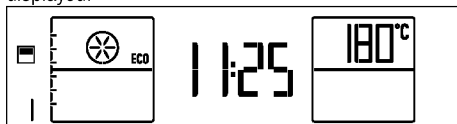
3. When the oven is switched on, the first function peculiar to the single large section cooking will be displayed.



Each time you touch , the bottom section only, both bottom and top sections and the top section only will be activated respectively.

4. Activate both sections by touching  twice.  will appear next to each oven section.

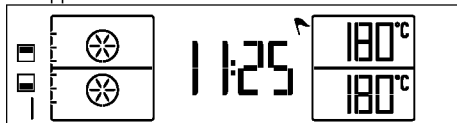

5. Touch  to enter the display for setting the operating function.

» The relevant function number will flash on the display.

6. Touching , select the desired function pair with the top section is selected as grill function.

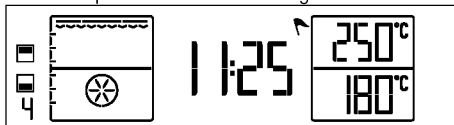

7. After the function is selected, "Temperature" and "Cooking time" can be adjusted separately for each oven section. For these settings  symbol of the active cooking section will flash. See. (Using the top and bottom sections of the oven simultaneously) *How to operate the oven control unit, page 23*

8. If cooking function, temperature and time values are suitable, touch  key to start cooking. Cooking starts.

9. The oven will automatically switch off at the end of the cooking time, if set. Two audible signals will be heard. If no cooking time is set, touch  again to end the cooking when the cooking process is complete.

10. Touch  key to switch off the oven.



Foods that are not suitable for grilling carry the risk of fire. Only grill food which is suitable for intensive grilling heat.

Do not place the food too far in the back of the grill. This is the hottest area and fatty food may catch fire.

For single large section: cooking times table for grilling

Food	Insertion level	Cooking time (approx. in min.)
Fish	4...5	20...25 min. #
Chopped chicken	4...5	25...35 min.
Lamb chop	4...5	20...25 min.
Roast Beef	4...5	25...30 min. #
Veal chop	4...5	25...30 min. #
Toast bread	5	1...2 min.
# depending on thickness		
It is suggested to perform a preheating for all foods for approx. 5 minutes.		

For top section only: cooking times table for grilling

Food	Insertion level	Cooking time (approx. in min.)
Fish	4...5	20...25 min. #
Chopped chicken	4...5	25...35 min.
Lamb chop	4...5	20...25 min.
Roast Beef	4...5	25...30 min. #
Veal chop	4...5	25...30 min. #
Toast bread	5	1...2 min.
# depending on thickness		
It is suggested to perform a preheating for all foods for approx. 5 minutes.		

6 Maintenance and care

General information

Service life of the product will extend and the possibility of problems will decrease if the product is cleaned at regular intervals.

**DANGER:**

Disconnect the product from mains supply before starting maintenance and cleaning works.
There is the risk of electric shock!

**DANGER:**

Allow the product to cool down before you clean it.
Hot surfaces may cause burns!

Clean the product thoroughly after each use. In this way it will be possible to remove cooking residues more easily, thus avoiding these from burning the next time the appliance is used.

No special cleaning agents are required for cleaning the product. Use warm water with washing liquid, a soft cloth or sponge to clean the product and wipe it with a dry cloth.

Always ensure any excess liquid is thoroughly wiped off after cleaning and any spillage is immediately wiped dry.

Do not use cleaning agents that contain acid or chloride to clean the stainless or inox surfaces and the handle. Use a soft cloth with a liquid detergent (not abrasive) to wipe those parts clean, paying attention to sweep in one direction.



The surface might get damaged by some detergents or cleaning materials.
Do not use aggressive detergents, cleaning powders/creams or any sharp objects during cleaning.

Do not use harsh abrasive cleaners or sharp metal scrapers to clean the oven door glass since they can scratch the surface, which may result in shattering of the glass.



Do not use steam cleaners to clean the appliance as this may cause an electric shock.

Cleaning the control panel

Clean the control panel and knobs with a damp cloth and wipe them dry.



Do not remove the control buttons/knobs to clean the control panel.
Control panel may get damaged!

Cleaning the inside of oven

To clean the side walls of the oven

(This feature is optional. It may not exist on your product.)

1. Remove the middle section plate from the oven
2. Pull the wire rack and take the pin no (1) out of its housing.

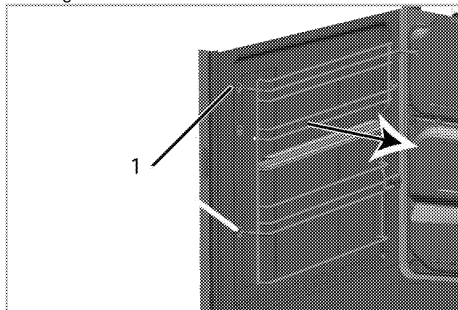

3. Remove the wire rack completely by pulling it out of the oven. Ensure that pin no 2 is removed from its housing in the back wall and that the tip no 3 is removed from the screw on side wall.

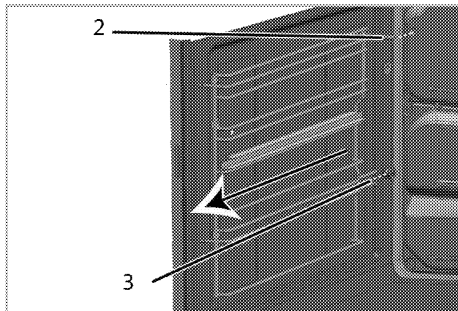

4. Clean the wire rack and the side walls of the oven by using a dish detergent, lukewarm water and a soft cloth or sponge, and dry it with a dry cloth.
5. Secure the wire rack pin to the oven, so as their pins (2) can go into the housings on the chassis and the tip no 3 goes into the screw found on the side wall.

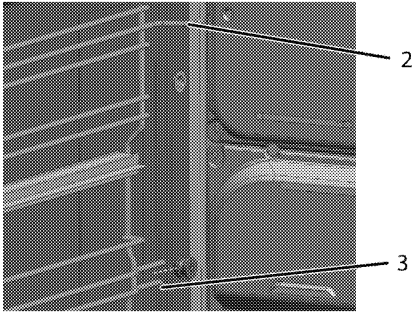

6. Insert the wire rack pin (1) to its housing found in the chassis.



Make sure that the wire rack is seated well into the housing.

Catalytic walls

(This feature is optional. It may not exist on your product.)

The inner side walls (A) and/or the rear wall (B) of your product may be coated with catalytic enamel. Catalytic walls have a light matte colour and a porous surface. Catalytic walls of the oven should not be cleaned. Porous surfaces of the catalytic walls are automatically cleaned by absorbing and converting the spilled oil (steam and carbon dioxide).

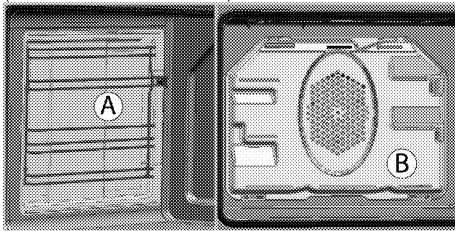

To clean oven door

Use warm water with washing liquid, a soft cloth or sponge to clean the oven door and wipe it with a dry cloth.



Do not clean the oven door and glass with materials that may damage the surface such as solid abrasive cleansers, metal scrapers, steel wool or bleachers.

Removing the oven door

1. Open the front door (1).
2. Open the clips at the hinge housing (2) on the right and left hand sides of the front door by pressing them down as illustrated in the figure.

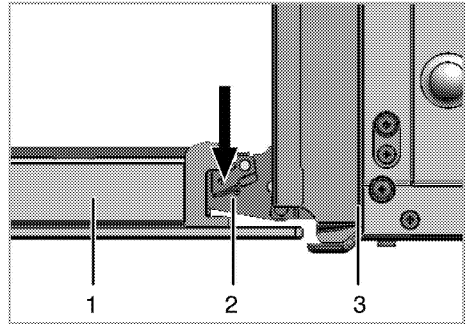

- 1 Front door
- 2 Hinge
- 3 Oven

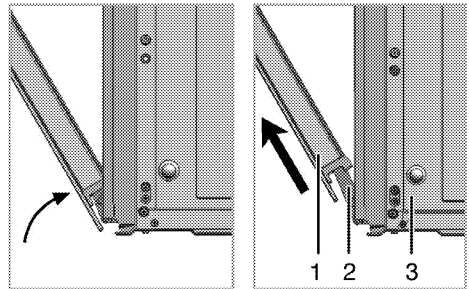

3. Move the front door to half-way.
4. Remove the front door by pulling it upwards to release it from the right and left hinges.



Steps carried out during removing process should be performed in reverse order to install the door. Do not forget to close the clips at the hinge housing when reinstalling the door.

Removing the door inner glass

(This feature is optional. It may not exist on your product.)

The inner glass panel of the oven door can be removed for cleaning. Open the oven door.

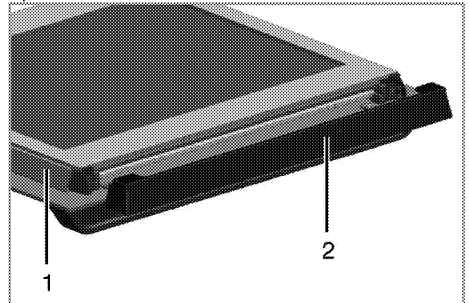

- 1 Frame

2 Plastic part

Pull towards yourself and remove the plastic part installed to upper section of the front door.

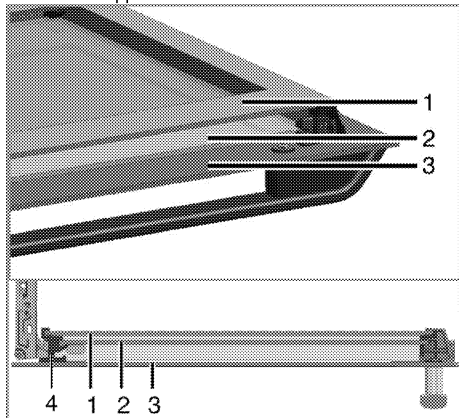

- 1 Innermost glass panel
- 2 Inner glass panel
- 3 Outer glass panel
- 4 Plastic glass panel slot-Lower

As illustrated in figure, raise the innermost glass panel (1) slightly in direction **A** and pull it out in direction **B**. Repeat the same procedure to remove the inner glass panel (2).

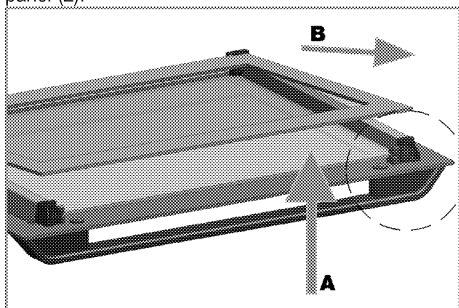

The first step to regroup the door is reinstalling inner glass panel (2).

As illustrated in figure, place the chamfered corner of the glass panel so that it will rest in the chamfered corner of the plastic slot.

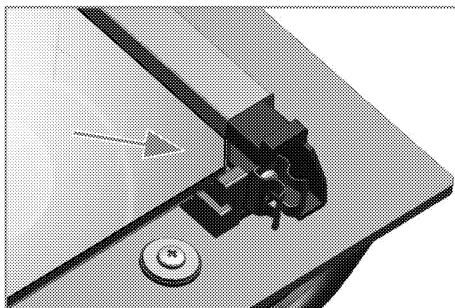

Inner glass panel (2) must be installed into the plastic slot close the innermost glass panel (1).

When installing the innermost glass panel (1), make sure that the printed side of the panel faces towards the inner glass panel.

It is important to seat lower corner of inner glass panel into the lower plastic slot.

Push the plastic part towards the frame until you hear a "click".

Replacing the oven lamp



DANGER:

Before replacing the oven lamp, make sure that the product is disconnected from mains and cooled down in order to avoid the risk of an electrical shock.
Hot surfaces may cause burns!



The oven lamp is a special electric light bulb that can resist up to 300 °C. See *Technical specifications, page 11* for details. Oven lamps can be obtained from Authorised Service Agents or technician with licence.



Position of lamp might vary from the figure.



The lamp used in this appliance is not suitable for household room illumination. The intended purpose of this lamp is to assist the user to see foodstuffs.



The lamps used in this appliance have to withstand extreme physical conditions such as temperatures above 50 °C.

If your oven is equipped with a round lamp:

1. Disconnect the product from mains.
2. Turn the glass cover counter clockwise to remove it.

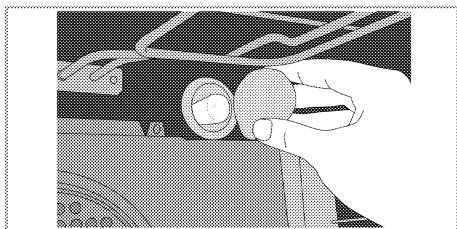

3. If your oven lamp is of type (A) shown in the figure below, remove it by rotating as shown and replace it. If it is of type (B), pull and remove it as shown in the figure and replace it.

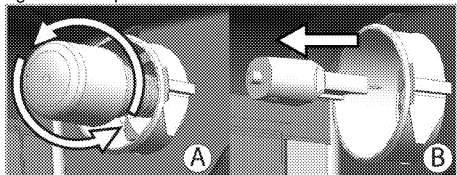

4. Install the glass cover.

If your oven is equipped with a square lamp:

1. Disconnect the product from mains.
2. Remove the wire racks as described. See .

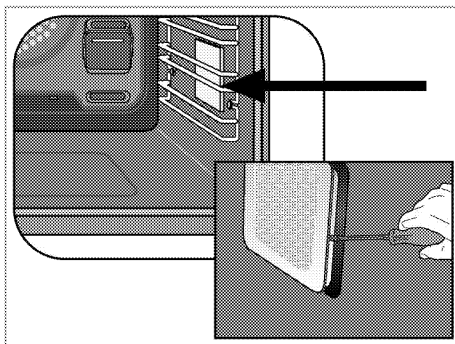

3. Remove the protective glass cover with a screwdriver.

4. If your oven lamp is of type (A) shown in the figure below, remove it by rotating as shown and replace it. If it is of type (B), pull and remove it as shown in the figure and replace it.

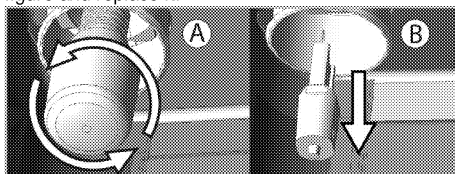

5. Install the glass cover and then the wire racks.

7 Troubleshooting

Oven emits steam when it is in use.

It is normal that steam escapes during operation. >>> *This is not a fault.*

Product emits metal noises while heating and cooling.

When the metal parts are heated, they may expand and cause noise. >>> *This is not a fault.*

Product does not operate.

The mains fuse is defective or has tripped. >>> *Check fuses in the fuse box. If necessary, replace or reset them.*

Product is not plugged into the (grounded) socket. >>> *Check the plug connection.*

Oven light does not work.

Oven lamp is defective. >>> *Replace oven lamp.*

Power is cut. >>> *Check if there is power. Check the fuses in the fuse box. If necessary, replace or reset the fuses.*

Oven does not heat.

Function and/or Temperature are not set. >>> *Set the function and the temperature with the Function and/or Temperature knob/key.*

Power is cut. >>> *Check if there is power. Check the fuses in the fuse box. If necessary, replace or reset the fuses.*



Consult the Authorised Service Agent or technician with licence or the dealer where you have purchased the product if you can not remedy the trouble although you have implemented the instructions in this section. Never attempt to repair a defective product yourself.

8 Guarantee Details

Your new Beko product is guaranteed against faulty materials, defective components or manufacturing defects. The guarantee starts from the date of original purchase of the product for a period of twelve (12) months unless Beko plc (the "Manufacturer") agrees to extend the guarantee for the product in writing. If you have any questions about the guarantee on your product (including how long it is valid), please contact your retailer or our Call Centre on 0333 207 9710.

This guarantee does not in any way diminish or affect your statutory rights in connection with the product. This guarantee is in addition to your statutory rights as a consumer. If you have any questions about these rights, please contact the retailer from which you purchased the product. In certain circumstances, it is possible that your statutory rights may offer additional or higher levels of protection than those offered under the terms of this guarantee.

What is covered by this guarantee?

Repairs to the product required as a result of faulty materials, defective components or manufacturing defects.
Functional replacement parts to repair a product.
The costs of a Beko Approved Engineer to carry out the repair.

What is not covered?

Transit and delivery damage.

Cabinet or appearance parts, including but not limited to control knobs, flaps and handles.

Accessories and/or consumable items including but not limited to ice trays, scrapers, cutlery baskets, filters and light bulbs.

Repairs necessary as a direct or indirect result of:

- Accidental damage, misuse or abuse of a product.
- An attempted repair of a product by anyone other than a Beko authorised repairer.
- Installation or use of a product where such installation or use fails to meet the requirements contained in this guarantee or the User Instructions Booklet.

Repairs to a product operated at any time on commercial or non-residential household premises (unless we have previously agreed to the installation environment).

This guarantee is limited to the cost of repairing the product. To the extent permitted by law, the Manufacturer does not accept and will not be held liable for any financial loss incurred in connection with the failure of any product to operate in accordance with the expected standards. Such financial loss includes but is not limited to loss arising from:

Time taken off work.

Damaged food, clothing or other items.

Meals taken at restaurants or from takeaways.

General compensation for inconvenience.

Important Notes

Your product is designed and built for domestic household use only.

The guarantee will automatically be void if the product is installed or is used in commercial or non-residential domestic household premises, unless we have previously agreed to the installation environment.

The product must be correctly installed, located and operated in accordance with the instructions contained in the User Instructions Booklet provided with your product.

Professional installation by a qualified Electrical Domestic Appliance Installer is recommended for all Washing Machines, Dishwashers and Electric Cookers (as incorrect installation may result in you having to pay for the cost of repairing the product).

Gas Cookers must be professionally installed by a Gas Safe (or Gas Networks Ireland for Republic of Ireland) registered gas installer.

This guarantee is given in respect of products purchased and used within the United Kingdom and the Republic of Ireland.

This guarantee is effective from the initial date of purchase of a new product from an authorised retailer and will be void if the product is resold.

This guarantee does not apply to graded sales (where the product is purchased as a "second").

Possession of a copy of these terms and conditions does not necessarily mean that a product has the benefit of this guarantee. If you have any questions, please call our Call Centre on the number set out above.

The Manufacturer reserves the right to terminate the guarantee if its staff or representatives are subjected to physical or verbal abuse in the course of carrying out their duties.

Optional extras, where available (i.e. extendable feet) are supplied on a chargeable basis only.

Does Beko offer replacements?

This is a repair-only guarantee. On occasion, the Manufacturer may at its sole discretion, replace your product with a new product instead of carrying out a repair. Where a replacement is offered, this would normally be an identical model but when this is not possible, a model of similar specification will be provided. The Manufacturer will cover the costs and arrange for the delivery of the new product and for the return of the old product. Any costs related to disconnecting the faulty product and installing the replacement product will not be borne by the Manufacturer unless previously agreed to in writing. The original guarantee will continue to apply to the replacement product; the new product will not come with a new guarantee.

When will the repair take place?

Our Engineers work Monday to Friday 9.00am to 5.00pm. Appointments outside these hours may be possible at the sole discretion of the Manufacturer but cannot be guaranteed. Whilst our Engineers will endeavour to minimize inconvenience and to meet requests for specific timed appointments, this cannot be guaranteed. We will not be liable for delays or if it is unable to carry out a repair because a convenient appointment cannot be arranged.

Will there be any charge for the repairs?

It is your responsibility to provide evidence to the Engineer that your product is covered by this guarantee with a proof of purchase. The Manufacturer reserves the right to charge for the reasonable cost of any service call if: You cannot provide evidence that your product is covered by this guarantee.

Where a service call has been made and the engineer finds that there is no fault with your product.

That your product has not been installed or operated in accordance with the User Instructions Booklet.

That the fault was caused by something other than faulty materials, defective components or manufacturing defects.

For missed appointments.

Payment of these costs are due immediately upon the Engineer providing you with an invoice. The Manufacturer reserves the right to terminate the guarantee if you fail to pay the costs for the service call in a timely manner.

If you are a resident of the United Kingdom, this guarantee will be governed by English law and subject to the English Courts, save where you live in another part of the United Kingdom, in which case the law and courts of that location will apply.

If you are resident in the Republic of Ireland, this guarantee will be governed by Irish law and the Irish courts will have jurisdiction.

HOW TO OBTAIN SERVICE

Please keep your purchase receipt or other proof of purchase in a safe place; you will need to have it should the product require attention under guarantee.

It will be useful if you complete the details below, as it will help us assist you when requesting service (the model number is printed on the Instruction Booklet and the serial number is printed on the Rating Label affixed to the appliance). Recording of these details alone will not count as proof of purchase. A valid proof of purchase is required for under guarantee service.

The area around the product must be easily accessible to the Engineer without the need for cabinets or furniture being removed.

It is your responsibility to ensure our Engineers have a clean and safe environment to carry out any repairs.

.....
Model No:

Serial No:

Retailer:

Date of purchase:
.....

For service under guarantee simply telephone the appropriate number below:

UK Mainland & Northern Ireland: 0333 207 9710 or customerservice@support.Beko.co.uk

Republic of Ireland: 01 862 3411 or customerservice@support.Beko.ie

Register your appliance: For UK registrations visit beko.co.uk/register and for the Republic of Ireland beko.ie/register.

Before requesting service please check the troubleshooting guide in the Operating Instructions as a charge may be levied where no fault is found even though your product may still be under guarantee.

Service once the manufacturers guarantee has expired

If you have purchased an extended guarantee please refer to the instructions contained within the extended guarantee agreement document, otherwise please call the appropriate number above where service can be obtained at a charge.

Should you experience any difficulty in obtaining service contact the Beko Customer Helpline on Tel: 0333 207 9710 or e-mail: CustomerService@support.beko.co.uk
.....

This guarantee is provided by Beko plc. Beko House, 1 Greenhill Crescent, Watford, Herts, WD18 8QU. Beko plc is registered in England and Wales with company registration number 02415578.

