

**BEKO**

**REFRIGERATION**

**CF1300APW**

**13.2 cu.ft.  
Chest  
Freezer**

**Operating  
Instructions**

Congratulations on your choice of a **BEKO** quality Appliance which has been designed to give you service for many years.

**WARNING!**

This appliance is not intended for use by person with reduced physical, sensory or mental capabilities or lack of experience and knowledge unless they have been given supervision or instruction concerning use of the appliance by a person responsible for their safety. Children should be supervised to ensure that they do not play with the appliance.

**IMPORTANT !**

DO NOT connect the appliance to the electricity supply until all packing and transit protectors have been removed.

- Leave to stand for at least 4 hours before switching on to allow compressor oil to settle if transported horizontally.
- If you are discarding an old product with a lock or latch fitted to the lid, ensure that it is left in a safe condition to prevent the entrapment of children.
- This freezer must only be used for its intended purpose i.e the storing and freezing of edible foodstuff.
- Do not dispose of the appliance on a fire. At **BEKO** , the care and protection of our environment is an ongoing commitment. This appliance which is among the latest range introduced is particularly environmentally friendly. Your appliance contains non CFC/HFC natural substances in the cooling system (Called R600a) and in the insulation (Called cyclopentane) which are potentially flammable if exposed to fire. Therefore, take care not to damage, the cooling circuit / pipes of the appliance in transportation and in use. In case of a damage do not expose the appliance to fire, potential ignition source and immediately ventilate the room where the appliance is situated.
- We suggest you contact your local authority for disposal information and facilities available.
- To obtain the best possible performance and trouble free operation from your appliance it is very important to carefully read these instructions.
- On delivery, check to make sure that the product is not damaged and that all the parts and accessories are in perfect condition.
- We do not recommend the use of extension leads and multi-way adapters.
- Failure to observe these instructions may invalidate your right to free service during the guarantee period.

**WARNING !** Do not use mechanical devices or other means to accelerate the defrosting process, other than those recommended by the manufacturer.

**WARNING !** Do not damage the refrigerant circuit.

**WARNING !** Do not use electrical appliances inside the food storage compartments of the appliance, unless they are of the type recommended by the manufacturer.

- We suggest you keep these instructions in a safe place for easy reference.

<b>BEKO CHEST FREEZER CF1300APW</b>	
<b>PERFORMANCE</b>	
Energy efficiency class	A+
Energy consumption - Kwh/year	318
Net storage – vol fresh food ltrs (cu.ft.)	-----
Net storage – vol frozen food ltrs (cu.ft.)	360 (12.7)
Total net vol – ltrs (cu.ft.)	360 (12.7)
Frozen food compartment rating	4 STAR
Conservation time from failure	36 hrs.
Freezing capacity fresh food – kg (lb) /24 hrs.	18 (40)
Climate class	SN-T
Operating noise level dB(A)	40

<b>CONTENTS</b>	<b>PAGE</b>
TRANSPORTATION INSTRUCTIONS	3
INSTALLATION INSTRUCTIONS	4
STARTING	5
FREEZER OPERATION	6
STORING FROZEN FOOD	7
FREEZING FRESH FOOD	7
DEFROSTING	8
CLEANING AND CARE	8
DO'S AND DON'TS	9
PROBLEM SOLVING/TROUBLE SHOOTING	10
REPLACING THE INTERIOR LIGHT BULB	10
GUARANTEE DETAILS	11
HOW TO OBTAIN SERVICE	12

## TRANSPORTATION INSTRUCTIONS

1. The appliance should be transported only in a vertical upright position. The packing as supplied must be intact during transportation.
2. If during the course of transport the product has been transported horizontally, it must only be laid on its left hand side (when facing the lid front) and it must not be operated for at least 4 hours to allow the system to settle after the appliance is brought back to upright position.
3. For the protection of the appliance during warehousing and transport, it is provided with spacers between the lid and the cabinet (in the front and rear side). These spacers will be removed before putting the appliance into operation.
4. Failure to comply with the above instructions could result in damage occurring to the appliance. The manufacturer will not be held responsible if these instructions are disregarded.
5. The appliance must be protected against rain, moisture and other atmospheric influences.

**IMPORTANT :** Care must be taken while cleaning / carrying the appliance to avoid touching the condenser metal wires at the back of the appliance, as you might injure your fingers and hands or damage your product.

**IMPORTANT :** This appliance is not designed for stacking with any other appliance. Do not attempt to sit or stand on top of your appliance as it is not designed for such use. You could injure yourself or damage the appliance.

**IMPORTANT :** Make sure that mains cable is not caught under the appliance during and after carrying / moving the appliance, to avoid the mains cable becoming cut or damaged.”

**IMPORTANT :** If the supply cord is damaged, it must be replaced by the manufacturer, its service agent or similarly qualified persons in order to avoid a hazard.

**IMPORTANT :** Excess deposit of ice on the frame and the baskets should be removed regularly with the plastic scraper provided. Do not use any metal parts to remove the ice.

The presence of this ice build-up makes impossible to close the lid correctly.

When positioning your appliance take care not to damage your flooring, pipes, wall coverings etc. Do not move the appliance by pulling by the lid or handle. Do not allow children to play with the appliance or tamper with the controls. BEKO plc. declines to accept any liability should the instructions not be followed.

## INSTALLATION INSTRUCTIONS

1. If possible avoid placing the appliance near cookers, radiators or in direct sunlight as this will cause the compressor to run for long periods. If installed next to a source of heat or refrigerator, maintain the following minimum side clearances:

From Cookers	4" (100 mm)
From Radiators	12" (300 mm)
From Fridges	4" (100 mm)

2. Make sure that sufficient room is provided around the appliance to ensure free air circulation. Ideally, ensure you allow gaps as shown in the below diagram.

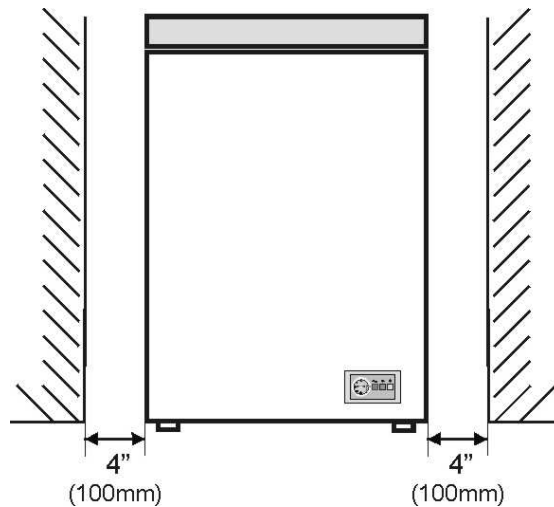

3. The appliance should be located on a smooth surface.
4. Refer to "Cleaning and Care" section to prepare your appliance for use.
5. Fit the two plastic wall spacer supplied with the appliance rotating 1/4 turn to the condenser at the back of the freezer (see diagram).

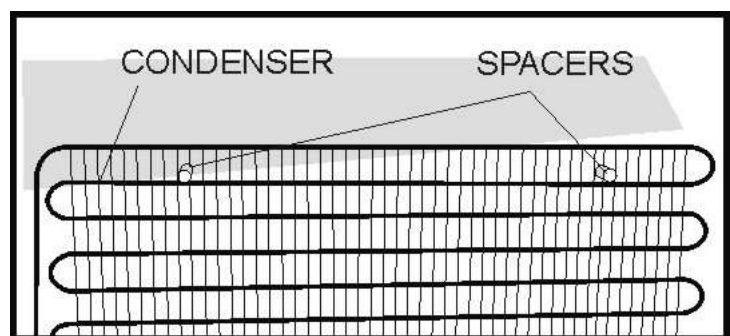

6. If the freezer is installed in unheated areas, garages etc., in cold weather condensation may form on the outer surfaces. This is quite normal and is not a fault. Remove the condensation by wiping with a dry cloth.

## STARTING

### Final Check

Before you start using the freezer check that:

1. The interior is dry and air can circulate freely at the rear.
2. Clean the interior as recommended under "CLEANING AND CARE".
3. Insert the plug into the wall socket and switch on the electricity supply. Avoid accidental disconnection by taping over the switch. Green light will glow and the compressor will start running (see Freezer Operation page 6).
4. You will hear a noise as the compressor starts up. The liquid and gases sealed within the refrigeration system may also give rise to noise, whether the compressor is running or not which is quite normal.
5. If you going to store already frozen food open the freezer lid and check that the freezer has reached the correct temperature. Then you can put in your already frozen food. (See Storing Frozen Food page 7).
6. If you are going to freeze fresh Food, you should turn the Fast Freeze switch on and wait for at least three hours before putting in your fresh food to be frozen. (See Freezing Fresh Food, Page 7).
7. Do not load the appliance immediately after it is switched on. Wait until the correct storage temperature has been reached. We recommend that you check the temperature with an accurate thermometer (see Freezer Operation page 6).

### Important Notes:

- If there is a power failure do not open the lid. Frozen food should not be affected if the failure lasts for less than 36 hours. If the failure is longer, then the food should be checked and eaten immediately or cooked and then refrozen.
- If you find that the lid of the chest freezer is difficult to open just after you have closed it, don't worry. This is due to the pressure difference which will equalize and allow the lid to be opened normally after a few minutes.

## **FREEZER OPERATION**

### ***Temperature adjustment***

The temperature of the freezer is adjusted by means of the knob assembled on the thermostat, position „MAX” being the lowest temperature.

The achieved temperatures can vary according to the conditions of use of the appliance, such as: place of the appliance, ambient temperature, frequency of lid opening, extent of filling with food of the freezer. The position of the thermostat knob will change according to these factors. Normally, for an ambient temperature of approx. 32<sup>0</sup>C, the thermostat should be adjusted to the mild position.

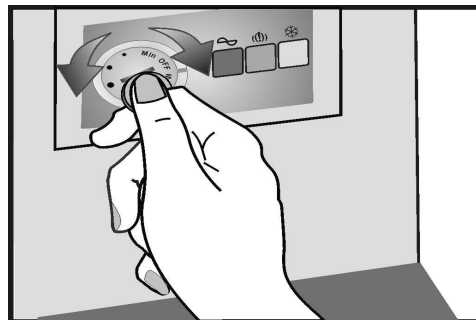

We recommended that you check the temperature with a thermometer to ensure that the Freezer is kept to the desired temperature. Remember you must take your reading very quickly since the thermometer temperature will rise very rapidly after you remove it from the freezer.

Please remember each time the lid is opened cold air escapes and the internal temperature rises. Therefore never leave the lid open and ensure it is closed: immediately after Food is put in or removed.

### ***Indicator lights***

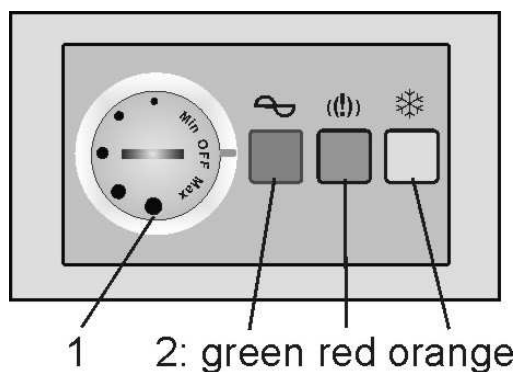

The indicator light set is placed on the front side of the freezer for easy visibility.

By using the Thermostat Adjustment Knob (1), you can adjust the internal temperature of the freezer.

Indicator lights mean the following:

- green LED – shows that the appliance is supplied with electric energy.
- red LED – lights if the temperature in the freezer is too high. The LED will operate 45 minutes after putting into operation of the freezer, then it must go off. If the LED comes on during the operation, this may mean that a defect has occurred.
- amber button and led – fast freeze is switched on.

## STORING FROZEN FOOD

Prepackaged commercially frozen food should be stored in accordance with the frozen food manufacturer's instructions for a  freezer compartment.

To ensure that the high quality achieved by the frozen food manufacturer and the food retailer is maintained the following should be remembered:

1. Put packets in the freezer as quickly as possible after purchase.
2. Do not exceed "Use By", "Best Before" dates on the packaging.

## FREEZING FRESH FOOD

Place fresh food to be frozen near the side walls to ensure fast freezing and away from already frozen food, if possible.

Freezing capacity of your appliance in a 24 hours period is 18 kg (11lb).

Never exceed this maximum capacity. If you are going to freeze fresh food in excess of 2 kg. (4.5lb) turn the Fast Freeze switch on and wait for at least three hours before placing the fresh food in the freezer. Remember to switch off the Fast Freeze after freezing. Do not freeze too large a quantity at any one time.

The quality of the food is best preserved when it is frozen right through to the centre as quickly as possible.

Take special care not to mix already frozen food and fresh food.

1. Lid handle
2. Lid
3. Lamp housing
4. Baskets
5. Tray
6. Lock housing
7. Control panel
8. Spacer for transport

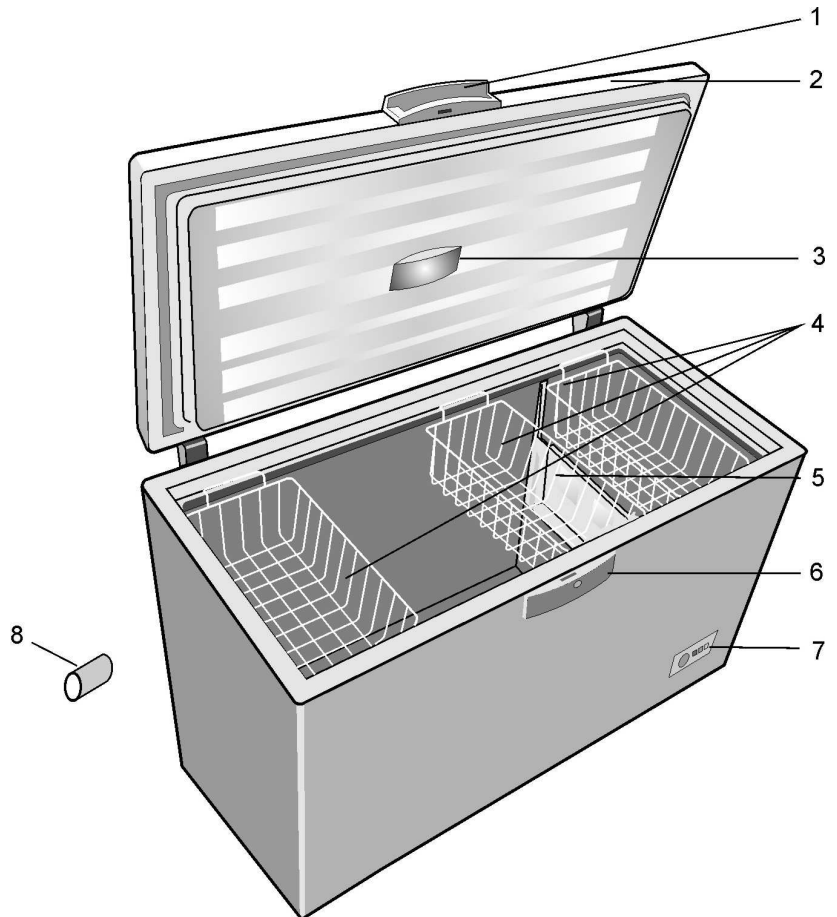



## DEFROSTING

Defrost twice a year or when a frost layer of around 7 mm (1/4") has formed.

To start the defrosting procedure turn the thermostat knob to zero position.

Alternatively you may switch off the freezer at the socket outlet and pull out the mains plug.

All food should be wrapped in several layers of newspaper and stored in a cool place (e.g. fridge or larder).

Remove the freezer baskets. Leave the lid open. Containers of warm water may be placed carefully in the freezer to speed up the defrosting.

Take out the frozen food, wrap it in several sheets of paper and put them in refrigerator or a cool place.

Take the separator panel and put it under the freezer in the direction of the dripping tube. Take out the obstructing plug. The water which results will be collected in the special tray (separator panel). After the melting of the ice and the run-off of the water please wipe with a cloth or with a sponge, then dry well. Put the obstruction plug back in its place.

For a fast thaw please leave the lid open.

Do not use pointed or sharp-edged objects such as knives or forks to remove the frost.

Never use hairdryers, electrical heaters or other such electrical appliances for defrosting.

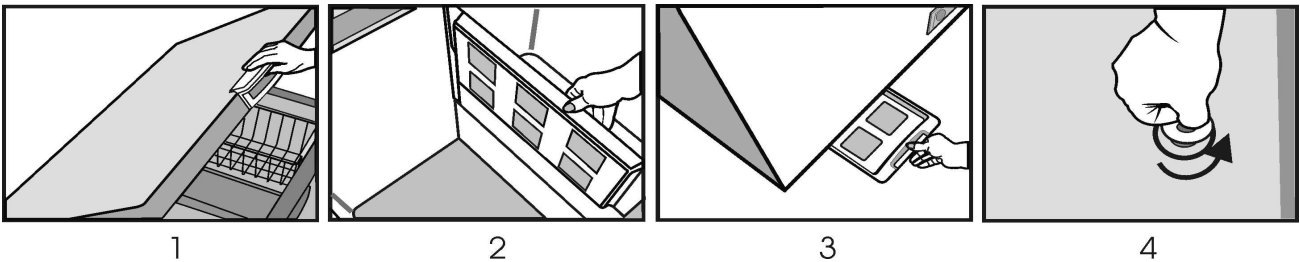

## CLEANING AND CARE

\*\* We recommend that you switch off the freezer at the socket outlet and pull out the mains plug before cleaning.

\*\* Never use any sharp abrasive instrument, soap, household cleaner, detergent and wax polish for cleaning.

\*\* Use luke warm water to clean the cabinet of the freezer and wipe it dry.

\*\* Use a damp cloth wrung out in a solution of one teaspoon of bicarbonate of soda to one pint of water to clean the interior and wipe it dry.

\*\* Excess deposit of ice should be removed on a regular basis using a plastic ice scraper available from your local store. Large accumulation of ice will impair the performance of the freezer.

\*\* If the freezer is not going to be used for a long period of time switch it off, remove all food, clean it and leave the lid ajar.

\*\* Any dust that gathers on the condenser, which is located at the back of the freezer, should be removed once a year with a vacuum cleaner.

\*\* Check lid seals regularly to ensure they are clean and free from food particles.

## DO'S AND DON'TS

**Do** – Defrost food from the freezer thoroughly in a fridge or in a microwave oven following defrosting and cooking instructions.

**Do** – Ensure that chest freezer lid is completely closed after each use.

**Do** – Defrost frozen meat completely before cooking.

**Do** – Close the lid gently.

**Do** – Check contents of the freezer at regular intervals.

**Do** – Clean and defrost your freezer regularly (See “Defrosting”)

**Do** – Keep food for as short a time as possible and adhere to “Best Before”, “Use By” dates.

**Do** – Store commercially frozen food in accordance with the instructions given on the packets that you buy.

**Do** – Always choose high quality fresh food and be sure it is thoroughly clean before you freeze it.

**Do** – Prepare fresh food for freezing in small portions to ensure rapid freezing.

**Do** – Wrap all foods in aluminium foil or freezer quality plastic bags and make sure any air is excluded.

**Do** – Wrap frozen food when you buy it and put it in to the freezer as soon as possible.

**Do** – Store small items in the basket provided.

**Do** – Remove ice cream from the freezer 10-20 minutes before serving.

**Don't** – Leave the lid open for long periods as this will make the freezer more costly to run and cause excessive ice formation.

**Don't** – Use pointed sharp edged objects such as knives, forks to remove the ice.

**Don't** – Put hot food in the freezer. Let it cool down first.

**Don't** – Put liquid-filled bottles or sealed cans containing carbonated liquids into the freezer as they may burst.

**Don't** – Store poisonous or dangerous substances in the freezer. Your freezer has been designed for the storage of edible foodstuffs only.

**Don't** – Exceed the maximum freezing capacity ( 5 kg in any 24 hours) when freezing fresh food.

**Don't** – Consume ice-cream and water ices direct from the freezer. The low temperature may cause ‘freezer burns’ on lips.

**Don't** – Freeze fizzy drinks.

**Don't** – Tray to keep frozen food which has thawed, it should be eaten within 24 hours or cooked and refrozen.

**Don't** – Remove items from the freezer with wet hands.

**Don't** – Shut the lid with force. You will damage the appliance.

## **PROBLEM SOLVING/TROUBLE SHOOTING**

- If the appliance does not operate when switched on, check;
- The plug is inserted properly in the socket and that the power supply is on. (To check the power supply to the socket, plug in another appliance)
- The fuse has blown / circuit breaker has tripped / main distribution switch has been turned off.
- The temperature control has been set correctly.
- New plug is wired correctly if you have changed the fitted moulded plug. If the appliance is still not operating after the above checks, please refer to the section on “How To Obtain Service”.

Please ensure that above checks have been made as a charge will be made if no fault is found.

## **REPLACING THE INTERIOR LIGHT BULB**

If the lamp burns out, disconnect the appliance from the mains. Take out the lamp trim. Make sure the lamp is screwed correctly. Plug in the appliance again. If the lamp still does not go on, replace it with another one model E14-15W. Mount back the lamp trim in its place.

## GUARANTEE DETAILS

Your new **BEKO** product is guaranteed against the cost of breakdown repairs for twelve months from the date of the original purchase.

### What is covered?

- Repairs necessary as a result of faulty materials, defective components or manufacturing defect.
- The cost of functional replacement parts, but excluding consumable items.
- The labour costs of a Beko approved repairer to carry out the repair.

### What is not covered?

- Transit, delivery or accidental damage or misuse and abuse.
- Cabinet or appearance parts, including knobs, flaps, handles or container lids.
- Accessories or consumable items including but not limited to, ice trays, scrapers, cutlery baskets, filters and light bulbs.
- Repairs required as a result of unauthorised repair or inexperienced installation that fails to meet the requirements contained in the user instruction book.
- Repairs to products used on commercial or non-residential household premises.
- Loss of frozen food in freezers or fridge/freezers. (Food loss insurance is often included within your household contents insurance policy, or may be available separately from your retailer).

### Important notes.

- Your Beko product is designed and built for domestic household use only.
- The guarantee will be void if the product is installed or used in commercial or non-residential domestic household premises.
- The product must be correctly installed, located and operated in accordance with the instructions contained in the User Instructions Booklet provided.
- Professional installation by a qualified Electrical Domestic Appliance Installer is recommended for all Washing Machines, Dishwashers and Electric Cookers
- Gas Cookers must only be installed by a CORGI (or BORD GAIS) registered Gas Installer.
- The guarantee is given only within the boundaries of the United Kingdom and the Republic of Ireland.
- The guarantee is applicable only to new products and is not transferable if the product is resold.
- Beko disclaims any liability for incidental or consequential damages.

The guarantee does not in anyway diminish your statutory or legal rights.

## HOW TO OBTAIN SERVICE

**Please keep your purchase receipt or other proof of purchase in a safe place; you will need to have it should the product require attention under guarantee.**

You should also complete the details below; it will help us assist you when requesting service. (The model number is printed on the Instruction Booklet and the serial number is printed on the Rating Label affixed to the appliance)

**Model No:      Serial No:      Retailer:      Date of purchase:**

**For service under guarantee simply telephone the appropriate number below**

### UK Mainland & Northern Ireland

Fridges & Freezers	0845 6004903
Electric Cookers	0845 6004902
Gas & Dual Fuel Cookers	0845 6004905
Washing Machines & Dishwashers	0845 6004906

### Republic of Ireland

All Refrigeration, All Cookers	01 862 3411
Washing Machines & Dishwashers	

**Before requesting service please check the trouble-shooting guide in the Operating Instructions as a charge may be levied where no fault is found even though your product may still be under guarantee.**

**Service once the manufacturers guarantee has expired.**

If you have purchased an extended guarantee please refer to the instructions contained within the extended guarantee agreement document. Otherwise please call the appropriate number above where service can be obtained at a charge.

Should you experience any difficulty in obtaining service please contact the Beko Customer Help-Line. Tel: 0845 850 5008 e-mail: [service@beko.co.uk](mailto:service@beko.co.uk)

#### Recycling



This product bears the selective sorting symbol for waste electrical and electronic equipment (WEEE). This means that this product must be handled pursuant to European Directive 2002/96/EC in order to be recycled or dismantled to minimize its impact on the environment. For further information, please contact your local or regional authorities.



Electronic products not included in the selective sorting process are potentially dangerous for the environment and human health due to the presence of hazardous substances.

