

beko



**Frost Free Combi
Fridge Freezer**

CFDL 7914W
CFDL 7914S

Please read this manual first!

Dear Customer,

We hope that your product, which has been produced in a 1st-class manufacturing facility and checked under the most meticulous quality control procedures, will provide you with years of good service.

For this, we recommend you to carefully read the entire manual of your product before using it and keep it at hand for future reference.



This manual

- Will help you use your appliance quickly and safely.
- Read the manual before installing and operating your product.
- Follow the instructions, especially those for safety.
- Keep the manual in an easily accessible place as you may need it later.
- Besides, read also the other documents provided with your product.

Please note that this manual may be valid for other models as well.

Symbols and their descriptions

This instruction manual contains the following symbols:

-  Important information or useful usage tips.
-  Warning against dangerous conditions for life and property.
-  Warning against electric voltage.

1 Your refrigerator	4	5 Using your refrigerator	16
2 Warnings	5	Thermostat setting button.....	16
Electrical requirements.....	7	Fridge Compartment Storage	
Warning! This appliance must be earthed.....	7	Advice.....	17
Energy saving tips.....	8	Defrosting	19
Compliance with WEEE Directive and Disposing of the Waste Product:	9	A) Fridge Compartment	19
Compliance with rohs directive:	10	B) Freezer Compartment.....	19
Package information.....	10	Icematic and ice storage container ..	19
3 Installation	11	Water Dispenser	20
Transportation Instructions.....	11	*optional.....	20
Changing the illumination lamp	12	6 Maintenance and cleaning	22
Installation Instructions	12	7 Do's and Don'ts	23
Reversing The Doors	13	Problem Solving	24
4 Before operating	15	8 Guarantee Details	25
Final Check	15	9 How To Obtain Service	26

1 Your refrigerator

Congratulations on your choice of a **Beko** quality Appliance which has been designed to give you service for many years.

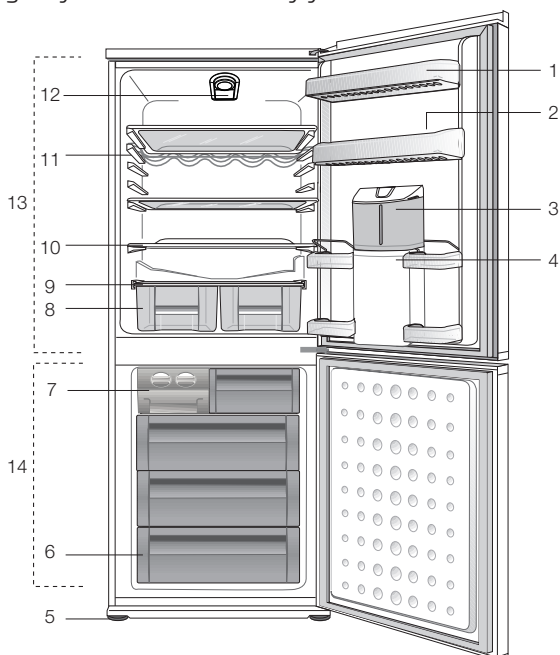

1. Door Shelves (Small bottles,cans, tubes)
2. Egg Tray
3. Water Dispenser Tank (Cold water)
4. Adjustable Shelves With Retainers (Tall large bottles)
5. Adjustable Front Feet
6. Freezing and Storage (store fresh food to be frozen lower down)
7. Twist & Serve ice cube trays and ice cube storage tray (Make and store ice cubes)

8. Crisper bins (for fresh fruit and vegetables)
9. Crisper cover
10. Adjustable Shelves
11. Bottle rack (White wine)
12. Thermostat knob
13. Fridge compartment
14. Freezer compartment

❏ Figures that take place in this instruction manual are schematic and may not correspond exactly with your product. If the subject parts are not included in the product you have purchased, then it is valid for other models.

2 Warnings

- Do not connect your appliance to the electricity supply until all packing and transit protectors have been removed.
 - If transported horizontally leave to stand upright for at least 4 hours before switching on to allow compressor oil to settle
 - If you are discarding an old refrigerator with a lock or latch fitted to the door, disable the lock/latch, ensure that it is left in a safe condition to prevent the entrapment of young children.
 - This fridge/freezer must only be used for its intended purpose i.e the storing and freezing of edible foodstuff.
 - Do not dispose of the appliance on a fire. At **Beko**, the care and protection of our environment is an ongoing commitment.
- This appliance which is among the latest range introduced is particularly environment friendly. Your appliance contains non CFC / HFC natural substances in the cooling system (Called R600a) and in the insulation (Called cyclopentane) which are potentially flammable if exposed to fire. Therefore, take care not to damage, the cooling circuit / pipes of the appliance in transportation and in use. In case of damage do not expose the appliance to fire or potential ignition source and immediately ventilate the room where the appliance is situated.
- We suggest you contact your local authority for disposal information and facilities available.
 - See Installation Instructions on page 8 for information on suitable location.

- To obtain the best possible performance and trouble free operation from your appliance it is very important to carefully read these instructions.
- On delivery, check to make sure that the product is not damaged and that all the parts and accessories are in perfect condition.
- Ensure that the plug remains readily accessible. Do not use multiple adapter or extension cable.
- Failure to observe these instructions may invalidate your right to free service during the guarantee period.
- Keep ventilation openings, in the appliance enclosure or in the built-in structure, clear of obstruction.
- Do not use mechanical devices or other means to accelerate the defrosting process, other than those recommended by the manufacturer.
- Do not damage the refrigerant circuit.
- Do not use electrical appliances inside the food storage compartments of the appliance, unless they are of the type recommended by the manufacturer.
- We suggest you keep these instructions in a safe place for easy reference.
- This appliance can be used by children aged from 8 years and above and persons with reduced physical, sensory or mental capabilities or lack of experience and knowledge if they have been given supervision or instruction concerning use of the appliance in a safe way and understand the hazards involved. Children shall not play with the appliance. Cleaning and user maintenance shall not be made by children without supervision.

- Children should be supervised to ensure that they do not play with the appliance.

Electrical requirements

Before you insert the plug into the wall socket make sure that the voltage and the frequency shown on the rating plate inside the appliance corresponds to your electricity supply.

Rating label is on the left hand side of fridge inner liner.

We recommend that this appliance be connected to the mains supply via a suitable switched and fused socket. The appliance must be positioned so that the plug is accessible.

WARNING:

When positioning the appliance ensure the supply cord is not trapped or damaged.

Should the mains lead of the appliance become damaged or should it need replacing at any time, it must be replaced

by a special purpose made mains lead which can only be obtained from a **Beko** authorised service agent.

Warning! This appliance must be earthed

If the fitted moulded plug is not suitable for your socket, then the plug should be cut off and an appropriate plug fitted. Destroy the old plug which is cut off as a plug with bared cord could cause a shock hazard if inserted into a socket elsewhere in the house.

The moulded plug on this appliance incorporates a 13 A fuse. Should the fuse need to be replaced an ASTABEAB approved BS 1362 fuse of the same rating must be used. Do not forget to refit the fuse cover. In the event of losing the fuse cover the plug must not be used until a replacement fuse cover has been fitted.

Colour of the replacement fuse cover must be the same colour as that visible on the pin face of the plug. Fuse covers are available from any good electrical store.

Important! Fitting A Different Plug

1. As the colours of the wires in the mains lead of this appliance may not correspond with the coloured markings identifying the terminals in your plug proceed as follows: (See diagram).
2. Connect the green-yellow or green (Earth) wire to the terminal in the plug marked 'E' or with the symbol  or coloured green and yellow or green.
3. Connect the blue (Neutral) wire to the terminal in the plug marked 'N' or coloured black.
4. Connect the brown (Live) wire to the terminal in the plug marked 'L' or coloured

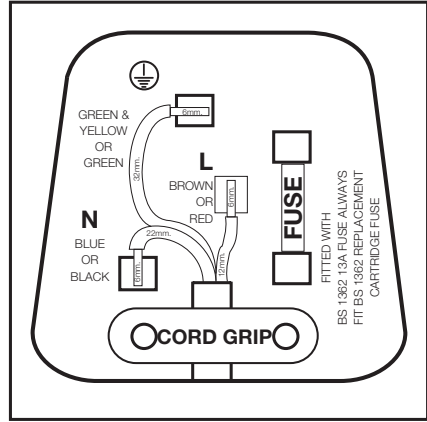

red.

5. With alternative plugs a 13 A fuse must be fitted either in the plug or adaptor or in the main fuse box. If in doubt contact a qualified electrician.

Energy saving tips

1. Ensure your appliance is installed in a well ventilated area.
2. Ensure the time between buying chilled/frozen food and placing them in your appliance is kept at minimum, particularly in summer. We recommend you use a cool bag or a special carrier bag to carry perishable food.

3. Do not leave the door (s) of your appliance open longer than necessary and ensure they are closed properly after each opening.
4. Defrost frozen food in the fridge compartment, so that frozen food acts as an ice pack to assist cooling in the fridge.
5. Energy consumption of this appliance is measured while freezer compartment is loaded without use of top shelf lid and the drawers except the bottom drawer. It is advised that freezer compartment is loaded without use of drawers except the bottom drawer in order to achieve maximum loading capacity.

Compliance with WEEE Directive and Disposing of the Waste Product:



This product complies with EU WEEE Directive (2012/19/EU).

 This product bears a classification symbol for waste electrical and electronic equipment (WEEE). This product has been manufactured with high quality parts and materials which can be reused and are suitable for recycling. Do not dispose of the waste product with normal domestic and other wastes at the end of its service life. Take it to the collection center for the recycling of electrical and electronic equipment. Please consult your local authorities to learn about these collection centers.

Compliance with rohs directive:

The product you have purchased complies with EU RoHS Directive (2011/65/EU). It does not contain harmful and prohibited materials specified in the Directive.

Package information

Packaging materials of the product are manufactured from recyclable materials in accordance with our National Environment Regulations. Do not dispose of the packaging materials together with the domestic or other wastes. Take them to the packaging material collection points designated by the local authorities.

3 Installation

Transportation Instructions

1. The appliance should be transported only in a vertical upright position. The packing as supplied must be intact during transportation.

2. If during the course of transport the appliance has to be transported horizontally, it must only be laid on its right hand side when standing in the front of the appliance. After bringing it to upright position, it must not be operated for at least 4 hours to allow the system to settle.

3. Failure to comply with the above instructions could result in damage occurring to the appliance. The manufacturer will not be held responsible if these instructions are disregarded.

4. The appliance must be protected against rain, moisture and other atmospheric influences.

5. When positioning your appliance take care not to damage your flooring, pipes, wall coverings etc. Do not move the appliance by pulling by the door or handle.

6. Empty any water in the drain tray before moving. See section 'Defrosting' and 'Care & cleaning' for further information.

7. Make sure that the defrost water pipe at the back of the product is fixed to the plastic evaporating pan on the top of the compressor, to avoid defrost water spillage on the floor.

8. The appliance must be protected against rain, moisture and other atmospheric influences.

9. The distance between ball wall and the back of refrigerator can not be bigger than 75 mm.

"Important: Care must be taken while cleaning / carrying the appliance to avoid touching the bottom of the condenser metal wires at the back of the appliance as you might injure your fingers and hands.

"Important: This appliance is not designed for stacking with any other appliance. When positioning your appliance, take care not to damage your flooring, pipes, wall coverings etc.

"Important: Care must be taken while cleaning / carrying the appliance to avoid touching the bottom of the condenser metal wires at the back of the appliance as you might injure your fingers and hands.

Do not attempt to sit or stand on top of your appliance as it is not designed for such use. You could injure yourself or damage the appliance.

"Important: Make sure that mains cable is not caught under the appliance during and after carrying / moving the appliance, to avoid the mains cable becoming cut or damaged. Do not allow children to play with the appliance or tamper with the controls.

Beko declines to accept any liability should the instructions not be followed.

Installation Instructions

1. Fitted the two plastic wall spacers supplied onto the condenser at the back of the appliance by rotating 1/4 turn.

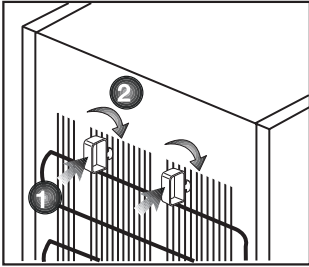

2. Locate the appliance on a smooth surface.

3. To ensure it is standing upright adjust the two front feet by turning clockwise or anti-clockwise, until it is in firm contact with the floor. Correct adjustment of feet avoids excessive vibration and noise.

4. A special receptacle is supplied to store the mains plug during transit. The receptacle is fixed at the back of the cabinet on the side of the compressor. Gently remove the plug from the receptacle. Never pull the mains cord, you may damage the appliance. In case of transportation, ensure you locate the plug in the receptacle provided to avoid transit damage.

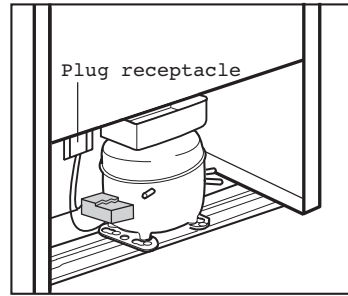
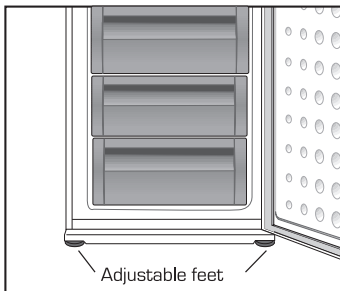

5. The space in the room where the appliance is installed must not be smaller than 10 cubic metres.

6. Fit the front grille supplied with your appliance as shown in the diagram.

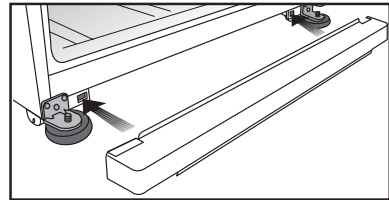

Changing the illumination lamp

To change the Bulb/LED used for illumination of your refrigerator, call your Authorized Service.

The lamp(s) used in this appliance is not suitable for household room illumination. The intended purpose of this lamp is to assist the user to place foodstuffs in the refrigerator/freezer in a safe and comfortable way.

Reversing The Doors

1. Switch off the appliance at the socket outlet and pull out the mains plug.

2. Remove all loose items and fittings and food, if any, from inside the appliance and door racks.

3. Unscrew the bolts and remove the middle hinge while holding doors. (1)

4. Remove the fridge door from the top hinge. (2)

5. Remove the freezer door. (3)

6. Remove the plastic covers on the front top trim. (4)

7. Unscrew the bolts of the top hinge and remove top hinge. (5)

8. Reposition plugs on the opposite side. (6)

9. Remove the kick plate. (7)

10. Carefully tilt the appliance on its back. (8) (You may need somebody to help you.)

11. Unscrew and remove the left hand side front feet. (9)

12. Unscrew and remove the bottom hinge. (10)

13. Remove the plastic cover and fit the tap which is in the plastic bag to the other side. (11)

14. Unscrew and remove the middle hinge bushing from fridge door. (12)

15. Screw and fix the new middle hinge bushing which is supplied in plastic bag to the other side. (13)

16. Reposition the hinge bushing and the tap on the freezer door. (14)

17. Unscrew and reposition the bottom hinge bushing. (15)

18. Unscrew bolt of the pin on the bottom hinge. Fit the pin to the other hole on the hinge and tighten the bolt on the new position. (16)

19. Fit the bottom hinge and other feet, and tighten the screws. (17)

20. Remove the plastic tap to the opposite side on the front bottom trim. (18)

21. Fit the front bottom trim to the bottom hinge and other feet. (19)

22. Rotate the top hinge 180°. Unscrew the hinge pin and re-tighten it to the opposite side. (20)

23. Fit the top hinge and tighten the bolts. (21)

24. Fit the plastic cover on the front top trim. (22)

25. Locate the freezer door to the bottom hinge and attach to the cabinet. (23)

26. Locate the middle hinge on the freezer door (24) and put the freezer door between the top and middle hinge carefully. (25)

27. Fit the middle hinge. Adjust the doors and tighten the bolts. (26)

28. Fit the door handle to the opposite side of the door and tighten the bolts. (27)

29. Carefully stand your appliance (you may need somebody to help you) adjust the front feet.

30. Put back all, loose items and fittings.

31. Wait for at least 4 hours to allow the system to settle before switching on.

32. Once the correct storage temperatures have been reached in the appliance, put back all the food.

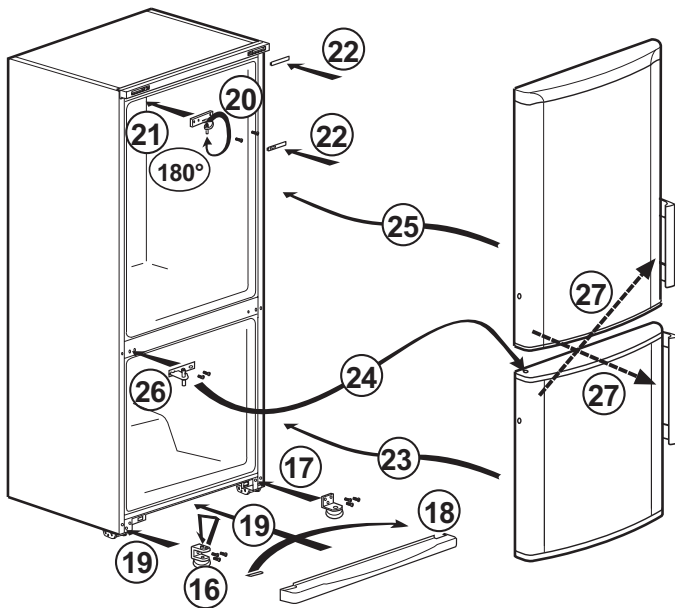
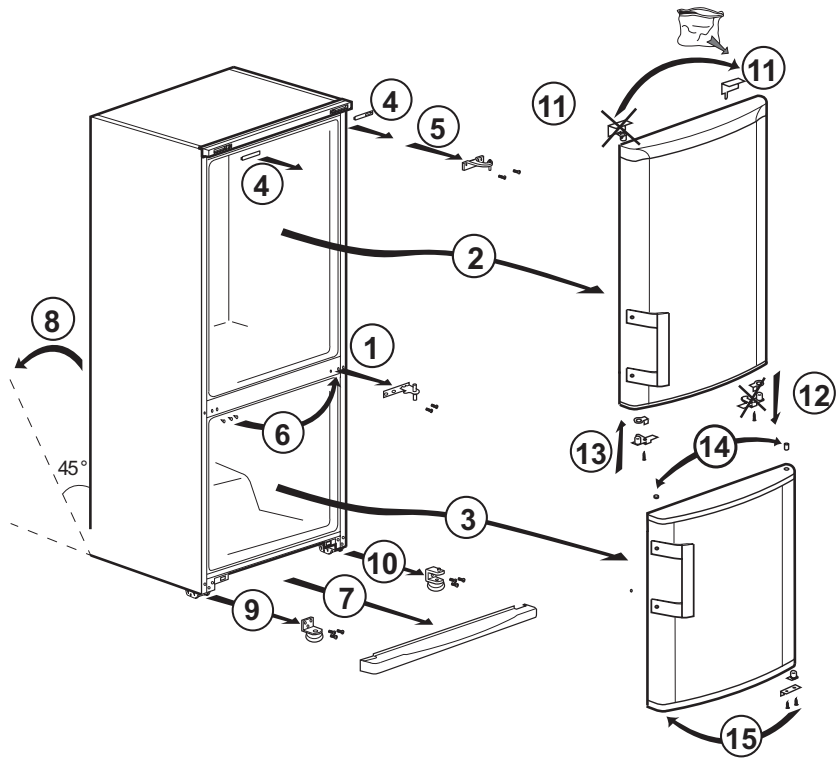

4 Before operating

Final Check

Before you start using the fridge/freezer check that:

1. The feet have been adjusted for perfect levelling.
2. The interior is dry and air can circulate freely at the rear of the cabinet.
3. Clean the interior as recommended under "CLEANING AND CARE."
4. Insert the plug into the wall socket and switch on the electricity supply.
5. When the door is open the fridge interior light will come on.
6. You will hear a noise as the compressor starts up. The liquid and gases sealed within the refrigeration system may also give rise to noise, whether the compressor is running or not which is quite normal. "Due to operation of the fan inside the frost free freezer compartment, overall noise level is slightly higher in comparison to non-frost free appliances. This is quite normal and is not a fault."
7. Set the setting knob half way between min and max.
8. Front edges of the cabinet may feel warm. This is normal. These areas are designed to be warm to avoid condensation.
9. "Do not load the appliance immediately it is switched on. Wait until the correct storage temperature has been reached. We recommend that you check the temperature with an accurate thermometer (see; Temperature Control and Adjustment)"
10. When the freezer reaches the desired temperature the freezer fan will stop. When the freezer fan is on, the noise will be louder when the freezer door is opened.
11. Avoid spillage of food particularly small items like rice, peas, beans through the fan guard as they may cause the cooling system to block and therefore operate less efficiently.

5 Using your refrigerator

Temperature Control And Adjustment

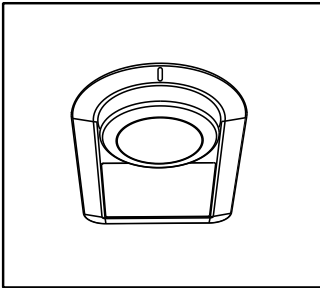

The operating temperature is regulated by the temperature control.

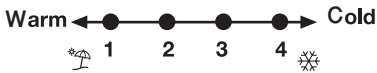

1=Lowest cooling setting (Warmest setting).

4=Highest cooling setting (Coldest setting).

The average temperature inside the fridge should be around +5°C.

Please choose the setting according to the desired temperature.

Please note that there will be different temperatures in the cooling area.

The coldest region is immediately above the vegetable compartment.

The interior temperature also depends on ambient temperature, the frequency with which the door is opened and the amount of foods kept inside.

Frequently opening the door causes the interior temperature to rise.

For this reason, it is recommended to close the door again as soon as possible after use.

Thermostat setting button

The interior temperature of your refrigerator changes for the following reasons;

- Seasonal temperatures,
- Frequent opening of the door and leaving the door open for long periods,
- Food put into the refrigerator without cooling down to the room temperature,
- The location of the refrigerator in the room (e.g. exposing to sunlight),
- You may adjust the varying interior temperature due to such reasons by using the thermostat. Numbers around the thermostat button indicates the cooling degrees.
- If the ambient temperature is higher than 32°C, turn the thermostat button to maximum position.
- If the ambient temperature is lower than 25°C, turn the thermostat button to minimum position.

Storing Fresh Food

Wrap raw meat and poultry loosely in polythene bags or aluminium foil. This prevents drying.

Wrap fish and offal in polythene bags and place on the lowest shelf. Dairy Wrap cheese firstly in greaseproof paper and then in polythene bag excluding as much air as possible. For best results take out of the fridge

compartment an hour before eating.

Wrap bread well to keep it fresh. Fruit & vegetables Take off any unusable leaves on vegetables and wipe off any soil.

Leave lettuce, cabbage, parsley and cauliflower on the stem.

Wrap pineapples, melons, cucumbers, tomatoes and similar produce in polythene bags as these types of produce may suffer damage if kept at very low temperatures.

Wrap food, which has a strong odour, or can dry out, in polythene bags, aluminium foil, or place in an airtight container.

Fridge Compartment Storage Advice

Fruit & vegetables

Don't store bananas. Don't store melon - it can be chilled for short periods as long as it is wrapped to avoid it flavouring other food.

Wrap food affected by temperatures near 0°C (pineapples, cucumbers, tomatoes etc.) in polythene bags.

Meat & poultry

Store raw meat and poultry below cooked food and dairy products. Do not allow raw meat to come into contact with cooked food to avoid contamination. For safety, only store raw meat for two to three days.

General

Cooked dishes must be stored in airtight covered containers. Don't store cooked and fresh food together in the same container. Always allow hot food and beverages to cool first. Leftover canned food should not be stored in the can.

Place chilled cooked food and similar food near the rear of the fridge where it is coldest.

Keep food for as short a time as possible and adhere to 'best before'

and 'use by' dates.

Don't let defrosting food or food juices drip onto other food. Do not fill water tank with any liquid other than drinking water; beverages such as fruit juice, carbonated fizzy soda drinks, alcoholic drinks are not suitable for use with water dispenser. If such liquids are used, water dispenser will malfunction and may be damaged beyond repair. Guarantee does not cover such uses. Some chemical ingredients and additives in such drinks / beverages may also attack and damage water tank material. Only use clean pure drinking water. Capacity of water dispenser tank is 2.2 litres [3.8 pints], do not overfill.

Push the water dispenser lever with a rigid cup. If you are using a plastic disposable cup, then push the lever with your fingers from behind the cup. Safety Locking knob is supplied for your convenience when filling the water tank and also to avoid small children tampering with the water dispenser.

Storing pre-frozen food

Take special care not to mix with fresh food.

The recommendation for  storage as stated on the food packaging must always be followed.

Pre-packed frozen food should be stored in accordance with the food manufacturer's instructions for a  frozen food storage compartment. To ensure that the high quality achieved by the food manufacturer and retailer is maintained:

1. Wrap packets when you buy them.

2. Put packets in the freezer as quickly as possible after purchase.
3. Ensure that contents are labelled and dated.
4. Do not exceed 'use by' and 'best before' dates.

Freezing fresh food

Take special care not to mix with already frozen food.

Always choose high quality fresh food and be sure it is thoroughly clean.

Prepare fresh food in small portions to ensure rapid freezing. Do not freeze too large a quantity at any one time. The quality is best preserved when the food is frozen right through to the core as quickly as possible.

Do not exceed the freezing capacity which in a 24 hour period is 6 kg (13 lbs).

When freezing the maximum amount, turn the setting knob to MAX.

When freezing average amounts, the setting knob can be kept at medium position. i.e. 2 kg (5lbs)

When freezing small quantities, up to 1/2 kg (1 lb), the setting knob will not need adjusting.

Preparation

Wrap food in aluminium foil or freezer quality polythene bags. Wrap fish and offal in polythene bags.

Wrap food which has a strong odour or can dry out, in polythene bags, aluminium foil, or place in airtight containers.

Make sure all air is excluded from foil wrapping or bags.

Freezer compartment storage info/advice

Do not leave frozen food at room temperature to thaw; the best way to defrost food is to put it in the fridge

to thaw slowly. Make sure you avoid defrosting food or food juices drip onto other food.

The freezer compartment is  rated and suitable for freezing food and the storage of pre-frozen food.

Don't freeze filled bottles or sealed cans containing fizzy (carbonated) drinks as they may burst.

Check contents of the freezer every so often. Don't close the freezer door before placing the fast freeze compartment cover in its place. Don't try to keep frozen food which has thawed, it should be eaten within 24 hours or cooked and re-frozen. If there is a power failure do not open the door. Frozen food should not be affected if the failure lasts for less than 18 hours. If the failure is longer, then the food should be checked and either eaten immediately or cooked and then re-frozen. Placing warm food into the freezer compartment causes the compressor to operate continuously until the food is frozen solid. This can temporarily lead to excessive cooling of the refrigeration compartment.

"The wire shelf between the two full depth plastic drawers can be removed temporarily if you want to store a turkey. After you remove the drawers,

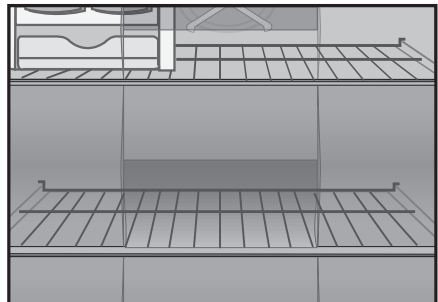

pull out the wire shelf as shown in the diagram. Reverse the sequence of operations when you re-fit the wire shelf back in to its position. Make sure you fit it properly otherwise operation of drawers will be affected."

Defrosting

A) Fridge Compartment

The fridge compartment defrosts automatically.

The defrosting water runs to the drain tube via a collection container at the back of the appliance (1). (see diagram) During defrosting water droplets may form at the back of the fridge compartment where concealed evaporator is located. Some droplets may remain on the liner and refreeze when defrosting is completed. Do not use pointed or sharp edged objects such as knives, forks to remove the droplets which have frozen.

If at any time the defrost water does not drain from the collection channel, check to ensure that no food particles have blocked the drain tube. The drain tube can be cleared by pushing the special plastic plunger provided down the drain tube (2). If the frost layer reaches about 1/4"(7 mm), reduce the setting (i.e. from 4 to 1) to restart automatic defrosting.

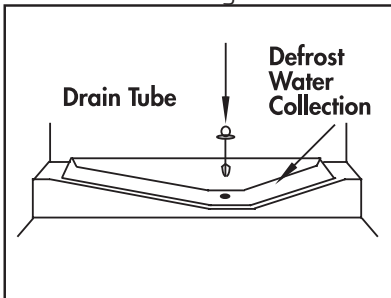

B) Freezer Compartment

The freezer compartment operation is frost free and does not need defrosting.

Icematic and ice storage container

*optional Using the Icematic

Fill the Icematic with water and place it into its seat. Your ice will be ready approximately in two hours. Do not remove the Icematic from its seating to take ice.

Turn the knobs on the ice reservoirs clockwise by 90 degrees.

Ice cubes in the reservoirs will fall down into the ice storage container below.

You may take out the ice storage container and serve the ice cubes.

If you wish, you may keep the ice cubes in the ice storage container.

Ice storage container

Ice storage container is only intended for accumulating the ice cubes. Do not put water in it. Otherwise, it will break.

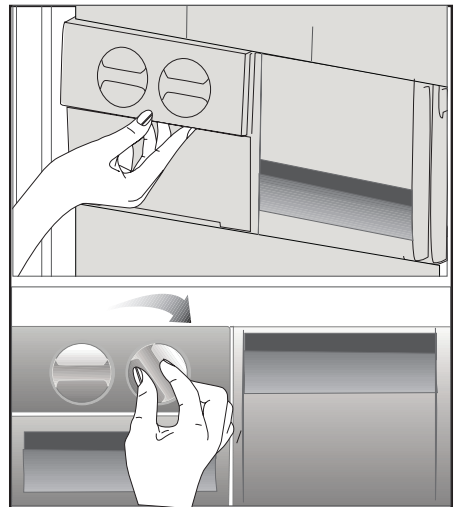

Water Dispenser

*optional

The water dispenser is a very useful feature allowing cold water on tap without opening the door of your refrigerator. As you will not have to open your refrigerator door frequently, you will have saved energy.

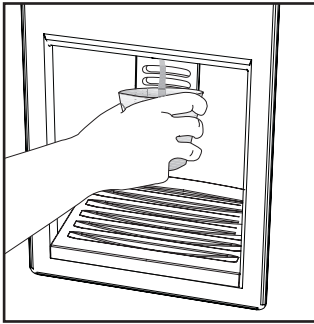

Using the water dispenser

Push the arm of the water dispenser with your glass. The dispenser will cease operating once you release the arm.

When operating the water dispenser, maximum flow can be obtained by pressing the arm fully. Please remember that the amount of flow from the dispenser is subject to the degree you press the arm.

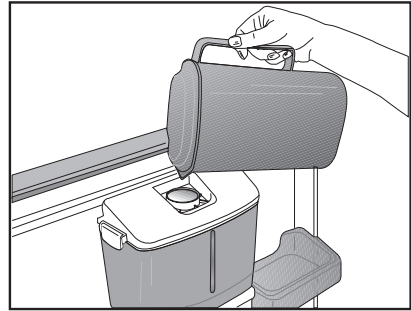

As the level of the water in your glass/container rises, slightly lessen the pressure on the arm to prevent the overspill. If you slightly press the arm, the water will drip; this is quite normal and not a failure.

Filling the water dispenser's tank

Open the cover of the water tank as shown in the figure. Fill in the pure and clean drinking water. Close the cover.

To avoid flowing of water by mistake, we recommend you to lock the water dispenser .

Warning!

- Do not fill the water tank with any other liquid except for water such as fruit juices, carbonated beverages or alcoholic drinks which are not suitable to use in the water dispenser. Water dispenser will be irreparably damaged if these kinds of liquids are used. Warranty does not cover such usages. Some chemical substances and additives contained in these kinds of drinks/ liquids may damage the water tank.
- Use clean and pure drinking water only.
- Capacity of the water tank is 2.2 Litres (3.8 pints); do not overfill.

- Push the arm of the water dispenser with a rigid glass. If you are using disposable plastic glasses, push the arm with your fingers from behind the glass.

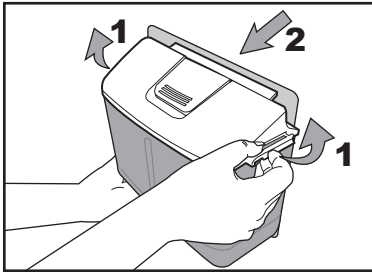

Cleaning the water tank

Release the tank cover from the water tank by opening latches on both sides. Remove the water tank and clean with warm and clean water. Place the water tank to its seating, install the tank cover and close the latches.

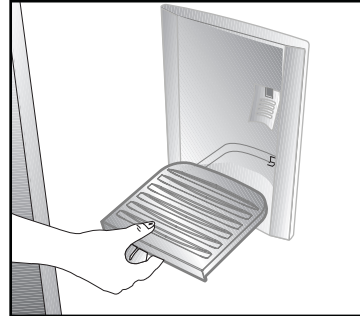
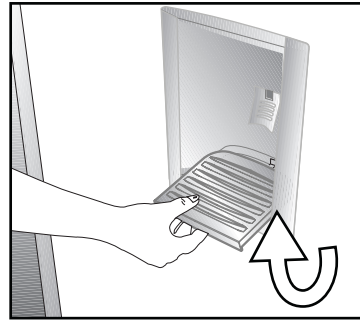
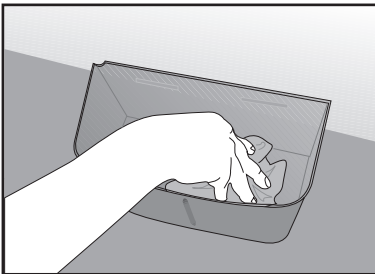
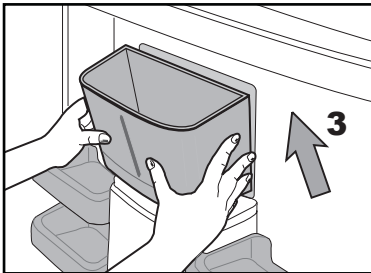

Make sure that the parts removed (if any) during cleaning are properly attached to their original places. Otherwise, water leakage may occur.

Important:

Components of the water tank and water dispenser should not be washed in dishwasher.

Water tray

Water that dripped while using the water dispenser accumulates in the spillage tray. Take out the spillage tray by pulling it towards yourself and empty it regularly.

Take out the plastic strainer by pressing it on sides.

Take the water valve out of the water tank. When replacing it, make sure that the seal is in place.

6 Maintenance and cleaning

- We recommend that you switch off the appliance at the socket outlet and pull out the mains plug before cleaning.
- Never use any sharp abrasive instrument, soap, household cleaner, detergent and wax polish for cleaning.
- Use luke warm water to clean the cabinet of the appliance and wipe it dry.
- Use a damp cloth wrung out in a solution of one teaspoon of bicarbonate of soda to one pint of water to clean the interior and wipe it dry.
- Make sure that no water enters the lamp housing.
- If the appliance is not going to be used for a long period of time switch it off, remove all food, clean it and leave the door ajar.
- Any dust that gathers on the condenser, which is located at the back of the appliance, should be removed once a year with a vacuum cleaner.
- Check door seals regularly to ensure they are clean and free from food particles.
- Removal of door tray
- To remove door racks, remove all the contents and then simply push the door rack upwards from the base.
- To remove a freezer drawer, pull it as far as possible, and then tilt it upwards, and then pull it out completely.
- To remove the freezer flap door, first open the door 3" and then gently pull it off. Make sure that the flap is in place before closing the freezer door.
- Make sure that the special plastic container (drain tray) at the back of the appliance which collects defrost water is clean at all times. If you want to remove the tray to clean it follow the instructions below :
 - Switch off at the socket outlet and pull out the mains plug.
 - Push the lug down with the tip of a screw driver & pull out with a jerk movement
 - Clean the drain tray and wipe it dry.
 - Reassemble reversing the sequence and operations.
 - Avoid spillage of food particularly small items like rice, peas, beans through the fan guard as they may cause the cooling system to block and therefore operate less efficiently.
 - ⚠ Never use cleaning agents or water that contain chlorine to clean the outer surfaces and chromium coated parts of the product. Chlorine causes corrosion on such metal surfaces.

7 Do's and Don'ts

Do- Clean your appliance regularly (See "Cleaning and Care")

Do- Keep raw meat and poultry below cooked food and dairy products.

Do- Take off any unusable leaves on vegetables and wipe off any soil.

Do- Leave lettuce, cabbage, parsley and cauliflower on the stem.

Do- Wrap cheese firstly in greaseproof paper and then in a polythene bag excluding as much air as possible. For best results take out of the fridge compartment an hour before eating.

Do- Wrap raw meat and poultry loosely in polythene or aluminium foil. This prevents drying.

Do- Wrap fish and offal in polythene bags.

Do- Wrap food which have a strong odour or can dry out in polythene bags, aluminium foil or place in an airtight container.

Do- Wrap bread well to keep it fresh.

Do- Chill white wines, beer, lager and mineral water before serving.

Do- Check contents of the freezer every so often.

Do- Keep food for as short a time as possible and adhere to "Best Before", "Use by" etc. dates.

Do- Store commercially frozen food in accordance with the instructions given on the packets that you buy.

Do- Always choose high quality fresh food and be sure it is thoroughly clean before you freeze it.

Do- Prepare fresh food for freezing in small portions to ensure rapid freezing.

Do- Wrap all food in aluminium foil or freezer quality polythene bags and make sure any air is excluded.

Do- Wrap frozen food when you buy it and put it in to the freezer as soon as possible.

Do- Defrost food in the fridge compartment.

Do- Remove ice cream from the freezer 10-20 minutes before serving.

Don't- Store bananas in your fridge compartment.

Don't- Store melon in your fridge. It can be chilled for short periods as long as it is wrapped to avoid it flavouring other food.

Don't- Store poisonous or any dangerous substances in your appliance. It has been designed for the storage of edible foodstuffs only.

Don't- Consume food which has been stored for an excessive time in the fridge.

Don't- Store cooked and fresh food together in the same container. They should be packaged and stored separately.

Don't- Let defrosting food or food juices drip onto food.

Don't- Leave the door open for long periods as this will make the appliance more costly to run and cause excessive ice formation.

Don't- Put hot food into the appliance. Let it cool down first.

Don't- Put liquid-filled bottles or sealed cans containing carbonated liquids into the freezer as they may burst.

Don't- Exceed the maximum freezing loads (6 kg in any 24 hours) when freezing fresh food.

Don't- Give children ice-cream and water ices direct from the freezer. The low temperature may cause 'freezer burns' on lips.

Don't- Freeze fizzy drinks.

Don't- Try to keep frozen food which has thawed, it should be eaten within 24 hours or cooked and refrozen.

Don't- Remove items from the freezer with wet hands.

Don't- Close the freezer door before placing the compartment cover in its place.

Don't- Leave frozen food at room temperature to thaw; the best way to defrost food is to put it in the fridge to thaw slowly. Make sure you avoid defrosting food or food juices drip onto other food.

Problem Solving

If the appliance does not operate when switched on, check whether:

- The plug is inserted properly in the socket and that the power supply is on. (To check the power supply to the socket, plug in another appliance)
- The fuse has blown/circuit breaker has tripped/main distribution switch has been turned off.
- The temperature control has been set correctly and not to "0" (OFF)
- New plug is wired correctly if you have changed the fitted moulded plug.

If the appliance is still not operating after the above checks, please refer to the section on "How To Obtain Service".

Please ensure that above checks have been made as a charge will be made if no fault is found.

8 Guarantee Details

GUARANTEE DETAILS

Your new Beko product is guaranteed against the cost of breakdown repair for twelve months from the date of the original purchase.

What is covered?

- Repairs necessary as a result of faulty materials, defective components or manufacturing defect
- The cost of functional replacement parts, but excluding consumable items.
- The labour costs of a Beko approved repairer to carry out the repair.

What is not covered?

- Transit, delivery or accidental damage or misuse and abuse.
- Cabinet or appearance parts, including control knobs, flaps, handles or container lids.
- Accessories or consumable items including but not limited to, ice trays, scrapers, cutlery baskets, filters and light bulbs.
- Repairs required as a result of unauthorised repair or inexperienced installation that fails to meet the requirements contained in the user instruction book.
- Repairs to products used on commercial or non-residential household premises.
- Loss of frozen food in freezers or fridge/freezers. (Food loss insurance is often included within your household contents insurance policy, or may be available separately from your retailer).

Important notes.

- Your Beko product is designed and built for domestic household use only.
- The guarantee will be void if the product is installed or used in commercial or non-residential domestic household premises.
- The product must be correctly installed, located and operated in accordance with the instructions contained in the User Instructions Booklet provided.
- Professional installation by a qualified Electrical Domestic Appliance Installer is recommended for all Washing Machines, Dishwashers and Electric Cookers
- Gas Cookers must only be installed by a Gas Safe (or BORD GAIS) registered Gas Installer.
- The guarantee is given only within the boundaries of the United Kingdom and the Republic of Ireland.
- The guarantee is applicable only to new products and is not transferable if the product is resold.
- Beko disclaims any liability for incidental or consequential damages. The guarantee does not in any way diminish your statutory or legal rights.

9 How To Obtain Service

HOW TO OBTAIN SERVICE

Please keep your purchase receipt or other proof of purchase in a safe place; you will need to have it should the product require attention under guarantee.

You should also complete the details below; it will help us assist you when requesting service. (The model number is printed on the Instruction Booklet and the serial number is printed on the Rating Label affixed to the appliance)

Model No: Obtaining service please contact Beko Customer Help-Line.

Serial No:

Retailer:

Date of purchase: Tel: 0845 6004911 or 0345 6004911

For service under guarantee simply telephone the appropriate number below

UK Mainland & Northern Ireland

Fridges & Freezers	0845 6004903	or	0345 6004903
Electric Cookers	0845 6004902	or	0345 6004902
Gas & Dual Fuel Cookers	0845 6004905	or	0345 6004905
Washing Machines & Dishwashers	0845 6004906	or	0345 6004906

Republic of Ireland

All Refrigeration 01 862 3411

All Cookers

Washing Machines & Dishwashers

Before requesting service please check the trouble-shooting guide in the Operating Instructions as a charge may be levied where no fault is found even though your product may still be under guarantee.

Service once the manufacturers guarantee has expired.

If you have purchased an extended guarantee please refer to the instructions contained within the extended guarantee agreement document. Otherwise please call the appropriate number above where service can be obtained at a charge.

Should you experience any difficulty in obtaining service please contact the Beko Customer Help-Line. Tel: 0845 6004911 e-mail: service@beko.co.uk

BEKO plc
Beko House
1 Greenhill Crescent
Watford
Hertfordshire
WD18 8QU
Tel: 0845 6004911
Fax: 0845 6004922
e-mail: service@beko.co.uk
website: www.beko.co.uk

www.beko.com

57 5831 0000
AA