

DG 682

# OVEN

## User Manual

## **Please read these instructions before installation or using your appliance!**

Dear Customer,

By purchasing this product you have chosen an appliance of advanced technology and high quality.

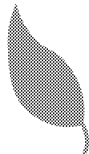

The appliance was produced in modern facilities which meet all environmental standards.

The instructions will help you to operate the appliance quickly and safely.

- Upon delivery, please check that the appliance is not damaged. If you note any transport damage, please contact your point of sale immediately and do not connect and operate the appliance!
- Before you connect and start using the appliance, please read this manual and all enclosed documents. Please note in particular the safety instructions.
- Keep all documents so that you can refer to the information again later on. Please keep your receipt for any repairs which may be required under warranty.
- When you pass on the appliance to another person, please provide all documents with it.



# Table of Contents

---

## **1 General information 4**

Overview .....	4
Technical Data .....	4
Accessories supplied with the unit .....	6
Injector Table .....	6

## **2 Safety Instructions 7**

Explanation of safety instructions .....	7
Basic safety instructions .....	7
Safety for children .....	8
Safety when working with gas .....	8
Safety when working with electricity ..	9
Intended use .....	10
Disposal .....	10
Packaging material .....	10
Old equipment .....	10
Future transportation .....	10

## **3 Installation 11**

Before installation .....	11
Installation and connection .....	12
Gas conversion .....	15

## **4 Preparation 18**

Tips for saving energy .....	18
Initial operation .....	18

First cleaning of the appliance .....	18
Initial heating .....	18

## **5 How to use the hob 19**

General information on cooking .....	19
How to use hobs .....	19

## **6 How to Operate the Oven 21**

General information on baking, roasting and grilling .....	21
How to use the gas oven .....	21
Cooking times table .....	23
How to operate the gas grill- Top oven	23
Cooking times table .....	24

## **7 Maintenance and Care 25**

General information .....	25
How to clean the hob .....	25
Cleaning the control panel .....	25
Cleaning the oven .....	25
Replacing the oven lamp .....	26

## **8 Troubleshooting 27**

## **9 Guarantee and Service 29**

# 1 General information

## Overview

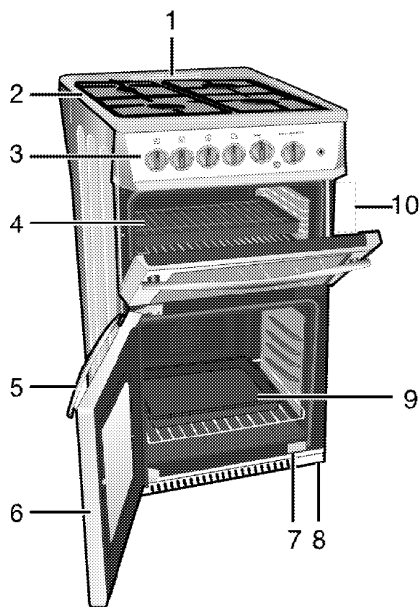

- |   |                     |    |                |
|---|---------------------|----|----------------|
| 1 | Integral air grille | 6  | Main oven door |
| 2 | Burners' plate      | 7  | Rating plate   |
| 3 | Control panel       | 8  | Foot           |
| 4 | Wire shelf          | 9  | Tray           |
| 5 | Handle              | 10 | Grill          |

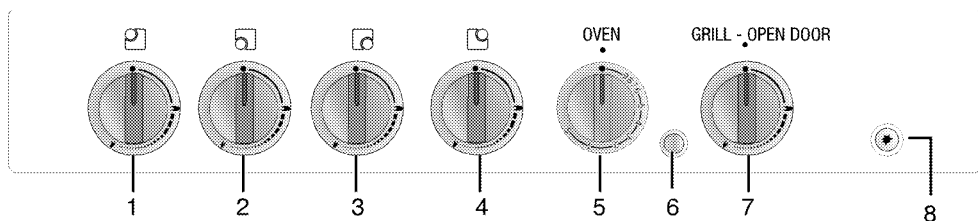

- |   |                             |   |                           |
|---|-----------------------------|---|---------------------------|
| 1 | Normal burner Rear left     | 5 | Main oven thermostat knob |
| 2 | Normal burner Front left    | 6 | Lamp button               |
| 3 | Rapid burner Front right    | 7 | Top cavity grill knob     |
| 4 | Auxiliary burner Rear right | 8 | Ignition button           |

## Technical Data

<b>GENERAL</b>	
Outer dimensions (height/width/depth)	900 mm/600 mm/600 mm
Voltage/frequency	230 V ~ 50 Hz
Total electric consumption	-
Fuse protection	min. 13 A
Cable type / cross section	H05VV-FG 3 x 0,75 mm <sup>2</sup> or equivalent
Cable length	max. 2 m
Gas device category	II <sub>2H 3P</sub>
Gas type/pressure	NG G 20/20 mbar
Total gas consumption	12,7kW
Conversion to gas type/pressure <sup>§</sup> – optional	G 31/37 mbar
<b>HOB</b>	
<b>Burners</b>	
Rear left	<b>Normal burner</b>
Power	2000 W
Front left	<b>Normal burner</b>
Power	2000 W
Front right	<b>Rapid burner</b>
Power	2900 W
Rear right	<b>Auxiliary burner</b>
Power	1000 W
<b>OVEN/GRILL</b>	
Top oven	<b>Gas Grill</b>
Inside illumination	-
Grill power consumption	2.3 kW
Main oven	<b>Gas oven</b>
Inside illumination	25–25 W
Oven power consumption	2.5 kW

## Accessories supplied with the unit



### Important

Accessories supplied can vary depending on the product model. All the accessories described in the user manual may not exist on your product.

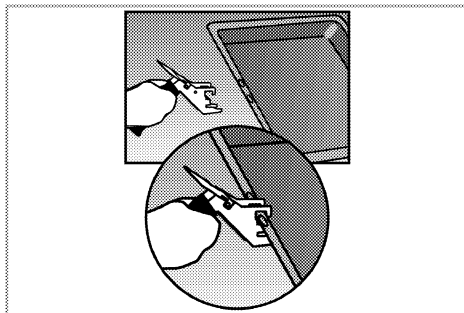

### Wire shelf and fat pan with handle

Can be used for both grilling and fat collection.

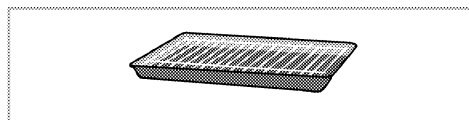

- Apply handle only at the holes in the middle of the fat pan.
- Remove handle for grilling.

### Injector Table

Position hob zone	2000 W Rear left	2000 W Front left	2900 W Front right	1000 W Rear right
Gas type / Gas pressure				
G 20/20 mbar	103	103	115	72
G 31/ 37 mbar	72	72	87	50
Gas type / Gas pressure	Gas oven		Grill	
G 20/20 mbar	110		113	
G 31/ 37 mbar	76		75	

call CUSTOMER SERVICES HELPLINE. 0845 600 4911 to order LPG injector kit.

## 2 Safety Instructions

---

### Explanation of safety instructions

The following types of safety instructions and information are used in this manual. They can be distinguished by the symbol and the initial signal word.

---



#### **DANGER**

##### **High risk of personal injury.**

Non-observance may or will cause serious injuries or death.

---



#### **CAUTION**

##### **Risk of personal injury.**

Non-observance may or will cause minor or medium injuries.

---



#### **NOTICE**

##### **Risk of material damage.**

Non-observance may or will cause damage on the appliance or other objects.

---



#### **Important**

##### **Tip for the user.**

Useful information on how to use the appliance. No injury risk information.

---

### Basic safety instructions

- The manufacturer reserves its right to make changes in the technical specifications in order to improve the appliance quality without any prior notice. Figures included in this manual are for schematic purpose only and may not match
  - exactly with your appliance. Values stated on the markings of the appliance or in other printed documents supplied with the appliance are obtained under laboratory conditions as per relevant standards. These values may vary according to the usage of the appliance and ambient conditions.
  - This appliance is not intended for use by persons (including children) with reduced physical, sensory or mental capabilities, or lack of experience and knowledge, unless they have been given supervision or instruction concerning use of appliance by a person responsible for their safety.
- Children should be supervised to ensure that they do not play with the appliance.
- "An additional protective means to avoid contact with the oven door is available. This part should be fitted when young children are likely to be present."
  - Never use when judgement or coordination is impaired by the use of alcohol and/or drugs.
  - Do not operate the appliance if it is defective or shows any visible damage.
  - Do not carry out any repairs or modifications on the appliance. However, you may remedy some malfunctions; see *Troubleshooting*, page 27.
  - Be careful when using alcoholic drinks in your dishes. Alcohol

evaporates in high temperatures and may cause fire since it will catch fire when it gets in contact with hot surfaces.

- Do not heat closed food containers and glass jars. Pressure that may build-up in the jar can cause it to burst.
- Ensure that no flammable materials are adjacent to the appliance as the sides become hot during use.
- Do not leave empty pots or pans on plates that are switched on. They might get damaged.
- Since it may be hot, do not leave plastic or aluminum dishes on the surface of appliance. These kind of dishes should not be used to keep food either.
- Do not place baking trays, dishes or aluminium foil directly onto the bottom of the oven. The heat accumulation might damage the bottom of the oven. Keep all ventilation slots clear of obstructions.
- Appliance may be hot when it is in use. Never touch the hot burners, inner sections of the oven, heating elements etc. Keep children away!
- Always use heat-resistant gloves when putting or removing the dishes into/from your oven.
- Don't use the cooker with front door glass removed.
- Rear surface of the oven gets hot when it is in use. Gas / Electric connection should not touch the rear surface, otherwise the mains cable may get damaged. Do not trap the mains cable between the

hot oven door and frame. Do not route the mains cable over the hot cooking section. Otherwise, cable insulation may melt and cause fire as a result of short circuit.

- Check all controls on the appliance are switched off after use.



### **Important**

For the warranty to be valid, the appliance must be installed by a qualified person in accordance with current regulations.

---

### **Safety for children**

- Accessible parts of the appliance will become hot whilst the appliance is in use and until the appliance has cooled, children should be kept away.
- Accessible parts may be hot when the grill is in use. Young children should be kept away.
- Do not store any items above the appliance that children may reach.
- The packaging materials will be dangerous for children. Keep the packaging materials away from children. Please dispose of all parts of the packaging according to environmental standards.
- When the door is open, do **not** load any heavy object on it and do **not** allow children to sit on it. It may overturn or door hinges may get damaged.

### **Safety when working with gas**

- Any works on gas equipment and systems may only be carried out



by authorised qualified persons who are Gas Safe registered.

- "Prior to the installation, ensure that the local distribution conditions (nature of the gas and gas pressure) and the adjustment of the appliance are compatible."
- "This appliance is not connected to a combustion products evacuation device. It shall be installed and connected in accordance with current installation regulations. Particular attention shall be given to the relevant requirements regarding ventilation;" See *Before installation, page 11*
- "The use of gas cooking appliance results in the production of heat and moisture in the room in which it is installed. Ensure that the kitchen is well ventilated: keep natural ventilation holes open or install a mechanical ventilation device (mechanical extractor hood). Prolonged intensive use of the appliance may call for additional ventilation, for example increasing the level of the mechanical ventilation where present."
- Gas appliances and systems must be regularly checked for proper functioning. Please arrange for annual maintenance.
- Clean the gas burners regularly. The flames should be blue and burn evenly.
- Good combustion is required in gas appliances. In case of incomplete combustion, carbon monoxide (CO) might develop. Carbon monoxide is a colourless,

odourless and very toxic gas, which has lethal effect even in very small doses.

- Request information about gas emergency telephone numbers and safety measures in case of gas smell from you local gas provider.

---

### What to do when you smell gas

---



#### **DANGER**

#### **Risk of explosion and poisoning!**

Do not use open fire and do not smoke.

Do not operate any electric switches (e.g. light switch or door bell).

Do not use a telephone or mobile phone.

---

1. Close all valves on gas appliances and gas meter.
2. Open doors and windows.
3. Check all tubes and connections for tightness. If you still smell gas leave the property.
4. Warn the neighbours.
5. Call the fire-brigade. Use a telephone outside the house.
6. Do not re-enter the property until you are told it is safe to do so.

### **Safety when working with electricity**

- Any work on electric equipment and systems may only be carried out by authorized qualified persons.
- In case of any damage, switch off the appliance and disconnect it from the mains supply by

removing the fuse or switching off the circuit breaker.

- Ensure that the fuse rating is correct.

## Intended use

The appliance is designed for domestic use only. Commercial use is not admissible.

This appliance should not be used for warming the plates under the grill, hanging towels and dish cloths etc. on the handles, drying and the heating purposes.

The manufacturer shall not be liable for any damage caused by improper use or handling errors.

The appliance can be used for defrosting, baking, roasting and grilling food.

## Disposal

### Packaging material

---



#### **DANGER**

#### **Risk of suffocation by the packaging materials!**

Keep children away from the packaging materials.

---

The packaging material and transport locks are made from materials that are not harmful to the environment. Please dispose of all parts of the packaging according to environmental standards. This is beneficial to the environment.

### Old equipment



This appliance bears the selective sorting symbol for waste electrical and electronic equipment (WEEE). This means that this appliance must be

handled pursuant to European Directive 2002/96/EC in order to be recycled or dismantled to minimize its impact on the environment. For further information, please contact your local or regional authorities.

Electronic appliances not included in the selective sorting process are potentially dangerous for the environment and human health due to the presence of hazardous substances.

## Future transportation

---



#### **NOTICE**

Do not place other items on the top of the appliance. The appliance must be transported upright.

---

Store the appliance's original box and transport the appliance in its original carton. Follow the guidance marks that are printed on the carton.

---



#### **Important**

Verify the general appearance of your equipment by identifying possible damage during the transportation.

---

Secure the caps and pan supports with adhesive tape.

To prevent the wire shelf and tray inside the oven from damaging the oven door, place a strip of cardboard onto the inside of the oven door that lines up with the position of the trays. Tape the oven door to the side walls.

### **If you do not have the original carton**

Pack the appliance in bubble wrap or thick cardboard and tape it securely in order to prevent damage during transportation.

### 3 Installation

#### Before installation

To ensure that critical air gaps are maintained under the appliance, we recommend that this appliance is mounted on a solid base and that the feet do not sink into any carpet or soft flooring.

The kitchen floor must be able to carry the weight of the appliance plus the additional weight of cookware and bakeware and food.

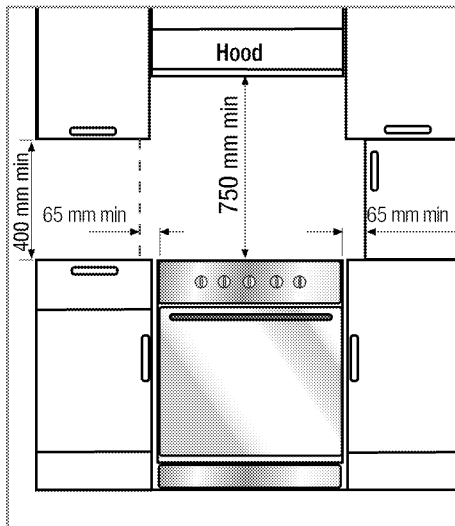

A safety distance must be left between the appliance and the kitchen walls and furniture. See figure (values in mm).

- It can be used with cabinets on either side but in order to have a minimum distance of 400mm above hotplate level allow a side clearance of 65mm between the appliance and any wall, partition or tall cupboard.

- It can also be used in a free standing position. Allow a minimum distance of 750mm from the hob surface to adjacent surfaces above the hob surface and 600mm to a cabinet above.
- If a appliance hood is to be fitted, refer to the manufacturer's instructions regarding fixing height.
- Movement of your appliance is most easily achieved by lifting the front as follows and pulling towards. Open the top oven door and the bottom oven door sufficiently to allow a comfortable grip on the underside front edge of the oven roofs. While gripping, it should be avoided to damage any grill elements or oven interior furniture.
- The appliance corresponds to device class 1, i.e. it may be placed with the rear and **one** side to kitchen walls, kitchen furniture or equipment of any size. The kitchen furniture or equipment on the **other** side may only be of the same size or smaller.
- Any kitchen furniture next to the appliance must be heat-resistant (100 °C min.).



#### Important

The appliance must be secured against overbalancing by using the supplied two safety chains on your oven. Fasten hook (1) to the kitchen wall (5) and connect safety chain (2) to the hook.

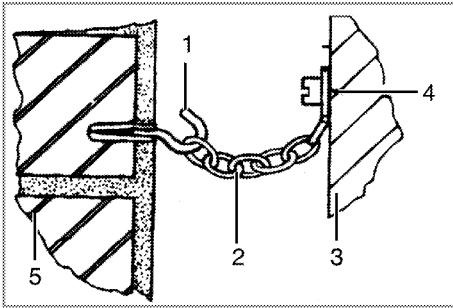

- 1 Hook (is not supplied)
- 2 Safety chain (supplied and mounted to oven)
- 3 Rear of cooker
- 4 Firmly fix chain to cooker rear
- 5 Kitchen wall

### Room ventilation

The air for combustion is taken from the room air and the exhaust gases are emitted directly into the room.

Good room ventilation is essential for safe operation of your appliance. If there is no window or door available for room ventilation, an extra ventilation must be installed.

Do not install this appliance in a room below ground level unless it is open to ground level on at least one side.

Failure to install correctly is dangerous and could result in prosecution.

Prolonged intensive use of the appliance may call for additional ventilation, for example the opening of a window, or the use of permanent fixed mechanical ventilation system, for example, an extractor fan or cooker hood that ventilates to the outside.

Room size	Ventilation opening
smaller than 5 m <sup>3</sup>	min. 100 cm <sup>2</sup>
5 m <sup>3</sup> to 10 m <sup>3</sup>	min. 50 cm <sup>2</sup>
greater than 10 m <sup>3</sup>	not required
In the cellar or basement	min. 65 cm <sup>2</sup>

## Installation and connection



### Important

Do not install the appliance next to refrigerators or freezers. The heat emitted by the appliance will lead to an increased energy consumption of cooling appliances.

- For installation the appliance must be connected in accordance with all local gas and/or electrical regulations.
- Carry the appliance with at least two persons.



### NOTICE

Material damage!

The door and/or handle must not be used for lifting or moving the appliance.

- The appliance must be placed directly on the floor. It must not be placed onto a base or a pedestal.

## Connection to the gas supply



### DANGER

**Risk of explosion or poisoning by unprofessional installation.**

The appliance may be connected to the gas distribution system only by an authorized qualified person who is Gas Safe registered.



## DANGER

### Risk of explosion!

Before starting any work on the gas installation, please shut off the gas supply.

- "The adjustment conditions for this appliance are stated on the label (or data plate)."
- In the UK, Gas Safe registered installers (Including the Regions of British Gas) undertake to work to safe and satisfactory standards.

## Regulations

The cooker must be installed in accordance with the Gas Safety (Installation and Use) Regulations and the relevant Building Regulations in force.

•



## NOTICE

Your appliance is adjusted for Natural gas.

The cooker is designed for UK installation using a flexible connection with tubing in accordance with the regulations in force. Length of 900mm is recommend.

Make sure that the natural gas valve is readily accessible.

Service Representative will remove the plug during connection and connect your appliance by means of a straight connection device (coupling).

If a flexible hose is used it must not come into contact with the top 150mm/6 inches (the shaded area on the diagram) of the rear of the appliance. Do not pass the hose through the hot region behind the oven.



## NOTICE

If you need to use your appliance later with a different type of gas, you must consult an authorised service centre for the related conversion procedure.

## Connecting the gas hose

Seal all connections with gas sealant.

1. Shut gas supply.
2. Screw connects cooker hose with bayonet fitting 3 and inlet valve.
3. Connect safety tube with valve with right angled elbow 4.

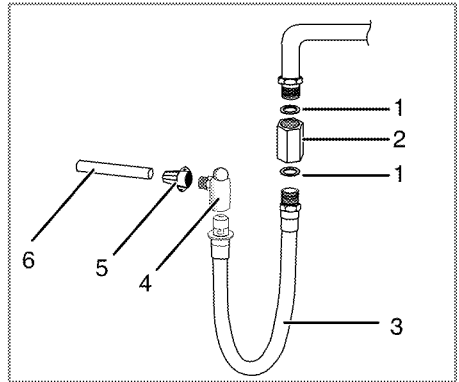

- 1 Seal
- 2 Adapter (optional) 1/2" outlet
- 3 Cooker hose with bayonet fitting
- 4 Valve with right angled elbow
- 5 Connection piece
- 6 Gas feeding tube



## DANGER

### Risk of explosion by damage of the safety tube!

The safety tube must not be clamped, bent or trapped or come into contact with hot parts of the appliance.

## Connection to the mains supply

---



### Important

#### **This appliance must be earthed!**

Our company shall not held responsible for any damage caused by using the appliance without earthed socket.

---



### DANGER

#### **Risk of electric shock, short circuit or fire by unprofessional installation!**

The appliance may be connected to the mains supply only by an authorized qualified person and the appliance is only guaranteed after correct installation.

---



### DANGER

#### **Risk of electric shock, short circuit or fire by damage of the mains lead!**

The mains lead must not be clamped, bent or trapped or come into contact with hot parts of the appliance.

If the mains lead is damaged, it must be replaced by a qualified electrician.

---

The mains supply data must correspond to the data specified on the rating plate of the appliance. The rating plate is either seen when the door or the lower cover is opened or it is located at the rear wall of the appliance depending on the appliance type.

The mains supply data must correspond to the data specified on the rating plate of the appliance. The rating plate is located at the rear housing of the appliance.

The supply cable of the appliance must correspond to the specifications; see technical data table *Technical Data*, page 5.

The moulded plug on this appliance incorporates a 13A fuse. Should the fuse need to be replaced an ASTA approved BS1362 fuse of the same rating must be used. Do not forget to refit the fuse cover. In the event of losing the fuse cover, the plug must not be used until a replacement fuse cover has been fitted. Colour of the replacement fuse cover must be the same colour as that visible on the pin face of the plug. Fuse covers are available from any good electrical store.

- **Fitting a different plug**

As the colours of the wires in the mains lead of this appliance may not correspond with the coloured markings identifying the terminals on your plug, proceed as follows:

- Brown cable = L (Live)
- Blue cable = N (Neutral)
- Green/yellow cable must be connected to ground (E)  line.

With the alternative plugs a 13A fuse must be fitted either in the plug or adaptor or in the main fuse box. If in doubt contact a qualified electrician.

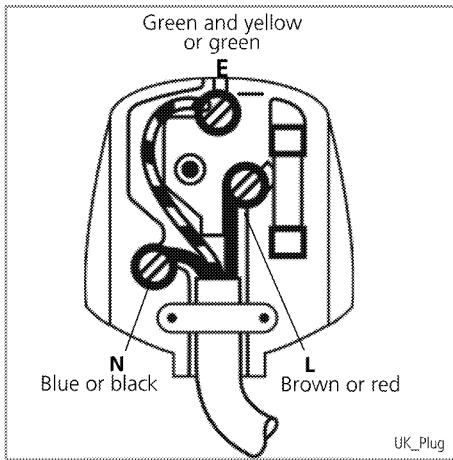

## Gas conversion



### DANGER

#### Risk of explosion!

Before starting any work on the gas installation, please shut off the gas supply.

In order to change your appliance's gas type, change all injectors and make flame adjustment for all valves at reduced flow rate position.

- **Gas conversion must only be carried out by a Gas Safe registered installer or service agent.**



### DANGER

#### Risk of electric shock!

Before starting any work on the electrical installation, please disconnect the appliance from the mains supply.

- Position appliance up to the kitchen wall.
- Securely attach safety chain to the wall behind the cooker.
- To align the appliance with the worktop, adjust the feet turning right or left hand as required.

### Final check

1. Check electrical functions.
2. Turn on gas supply.
3. Check gas installations for secure fitting and tightness.
4. Ignite burners and check appearance of the flame.



### Important

The flames should be blue and burn smoothly. If the flames appear yellowish, check secure position of the burner cap or clean the burner. Switch off gas and let burner cool before touching it.

### Adjust reduced flow for hobs

The burners plate must be removed for adjusting the gas hobs.

1. Take off all burner components from the burners plate.
2. Unscrew fastening screws of the burners plate.

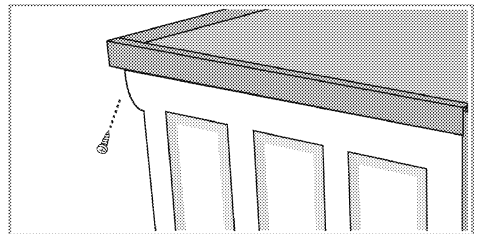

3. Lift hob and place it towards the back, and place it towards the back.

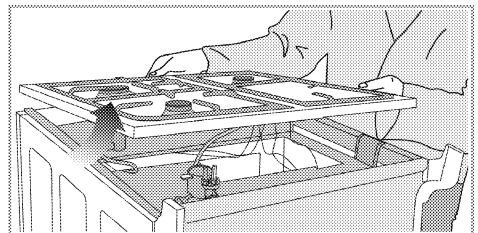

4. Unscrew upper fastening screws of the control panel.

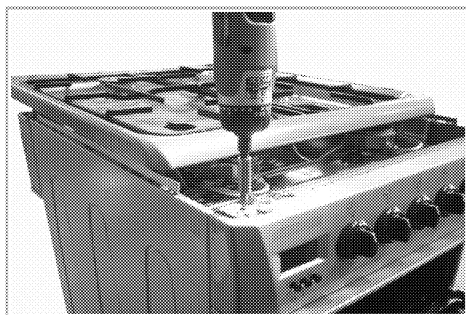

5. Open oven door.
6. Unscrew to two screws 1 located under the control panel and remove the panel bottom sheet.

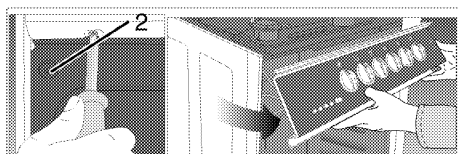

- 1 Screw
  - 2 Flow rate adjustment screw
  - 3 Control panel
7. Release the control panel by releasing it from the two notches and keep it free by taking care of the cable connections.
  8. Ignite the burner that is to be adjusted and turn the knob to the reduced position.
  9. Use an appropriately sized screwdriver to adjust the flow rate adjustment screw from the injector 2 that is on the gas tap.

It is sufficient to tight to screw for LPG (butane-propane) gas.

For the natural gas, you should turn the screw **counter-clockwise** once.

» The normal length of a straight flame in the reduced position should be 6-7 mm.

10. If the flame is higher than the desired position, turn the screw clockwise. If the smaller turn anticlockwise.
11. For the last control, bring the burner both to high-flame and reduced positions and check whether the flame is on or off.

### Exchange injector for the grill

1. Remove burner plate and control panel.
2. Separate injector holder segment 2 from spring clip 1.

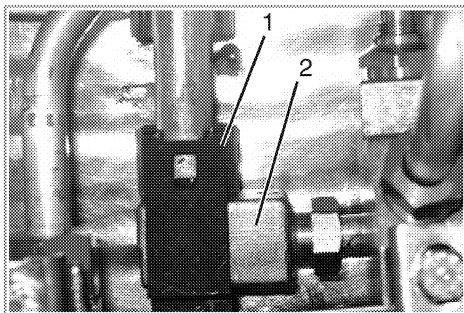

- 1 Spring clip
  - 2 Injector holder
3. Turn grill pipe 1 in clockwise direction.

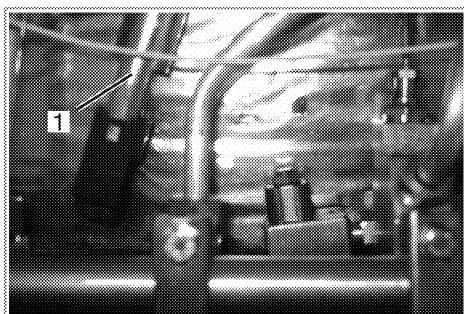

- 1 Grill pipe
- 2 Injector
- 3 Injector holder



4. Remove injector holder.
5. Unscrew injector.

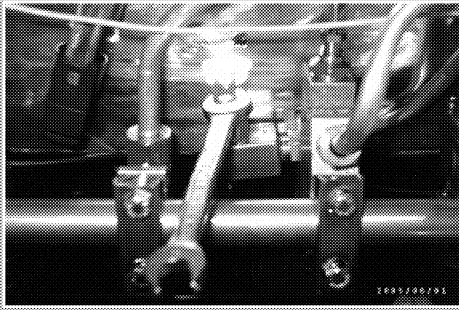

6. Fit new injector.

### Reduced flow adjustment for the gas oven

Reduced flow rate adjustment is extremely important for the appropriate functioning of the oven. In order to provide maximum security to the user these operations have to be done with care.

1. Open the front door.
2. Unscrew to two screws 1 located under the control panel and remove the panel bottom sheet.

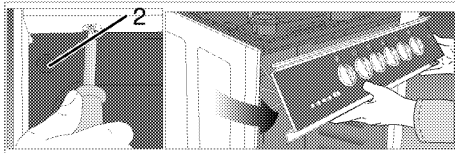

- 1 Screw
  - 2 Flow rate adjustment screw
  - 3 Control panel
3. Release the control panel by releasing it from the two notches and keep it free by taking care of the cable connections.

4. Ignite the burner that is to be adjusted and turn the knob to the high flame position.
5. Close the oven door and wait for 10 to 15 minutes until the oven becomes ready for adjustment.
6. After 15 minutes, adjust the oven to the lowest flame position.
7. Set the flame length to 2 to 3 mm by means of the screw 2 on the oven tap. Turning in clockwise direction reduces the flame, turning anticlockwise increases the flame.

### **i** Important

If the temperature of the oven increases unintendedly, turn off the oven and call the authorised service to have oven thermostat repaired.

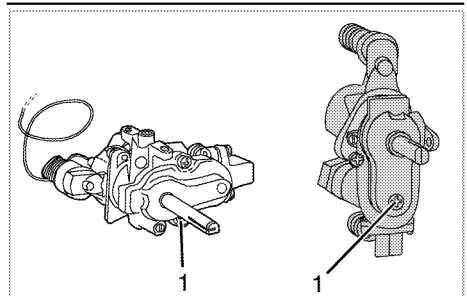

Butan/propan	Natural gas
Fasten the screw until the end	Loosen the screw 1/2 round

### **!** NOTICE

If the gas type of the unit is changed, then the rating plate that shows the gas type of the unit must also be changed.

## 4 Preparation

---

### Tips for saving energy

The following tips will help you to use your appliance in an ecological way and to save energy:

- Use dark coloured and enamel coated trays, since the heat transmission will be better.
- While cooking your meals, perform a preheating operation if it is advised in the user manual or cooking instructions.
- During cooking, do not open the oven door frequently.
- Try to cook more than one type of meal within the oven at the same time (You can cook two different meals at the same time by locating cooking bowls on the same shelf). It will be suitable to cook more than one meal after each other. The oven will already be hot.
- Defrost frozen meals before cooking them.
- Use pots/pans with lids for cooking. Without a lid, the energy consumption may be up to four times higher.
- Choose the burner/plate which is suitable to the saucepan base. Always choose the correct size of saucepans for your meals. For larger burners/plates more energy is needed.

### Initial operation

#### First cleaning of the appliance

---



#### NOTICE

The surface might get damaged by some detergents or cleaning materials.

Do not use aggressive detergents, cleaning powder/cream or any sharp objects.

---

1. Remove all packaging materials.
2. Wipe the surfaces of the appliance with a damp cloth or sponge and dry with a cloth.

#### Initial heating

---



#### WARNING

#### Hot surfaces may cause burns!

Do not touch the hot surfaces of the appliance. Use oven gloves. Keep children away from the appliance.

Allow the appliance to cool down before you take off the heat shield.

---



#### Important

Smell and smoke may emit during first heating. Ensure that the room is well ventilated.

---

Any production residues or conservation layers must be burnt off before the first use. Heat up the appliance for about 30 minutes and then switch it off.

#### Gas oven

1. Take all baking trays and wire shelf from the oven.
2. Close oven door.
3. Select largest flame of the gas oven; see *How to use the gas oven, page 21*.
4. Heat approximately 30 minutes.
5. Switch off oven; see *How to use the gas oven, page 21*

## 5 How to use the hob

### General information on cooking



#### **DANGER**

#### **Risk of fire by overheated oil!**

When you heat oil, do not leave it unattended.

**Never try to extinguish the fire with water!** When oil has caught fire, immediately cover the pot or pan with a lid. Switch off the hob if safe to do so and phone the fire service.

- Ensure handles of pans cannot accidentally be caught or knocked and do not get hot by adjacent heating zones. Avoid pans that are unstable and easily tipped. Pans that are too heavy to move easily when filled can also be a hazard. Only use flat bottomed pots or pans.
- Use pans which have sufficient capacity for the amount of food being cooked so they don't boil over and cause unnecessary cleaning.  
Do not place lids on the burners. Always position pans centrally over the burners. When transferring pans from one burner to another always lift the pans do not slide them.

### Cooking with gas

- The size of the pan and the size of the gas flame should match each other. Adjust the gas flames so that they do not go beyond the bottom of the pan always place

the pan onto the pan support in a central position.

### How to use hobs

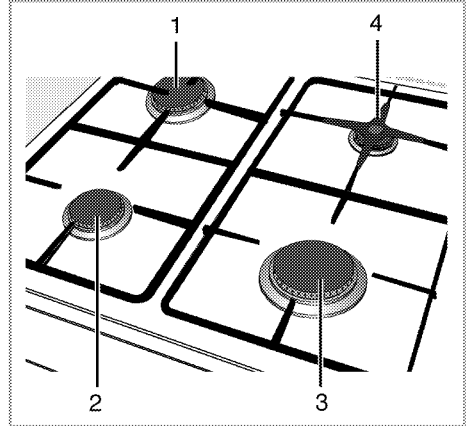

- 1 Normal burner 18-20 cm
- 2 Normal burner 18-20 cm
- 3 Rapid burner 22-24 cm
- 4 Auxiliary burner 12-18 cm is list of advised diameter of pots to be used on related burners.

The large flame symbol corresponds to the highest cooking power, the small flame symbol corresponds to the lowest cooking power. In the off position (top) the gas supply to the burner is turned off.

### Ignite the gas burners



The gas burners are ignited by means of the ignition button.

1. Keep hob control knob pressed.
2. Turn anticlockwise to the large flame symbol.

3. Press ignition button and release it again. Repeat the process until the emanating gas is lit.
4. Adjust to the desired cooking power.

### Switch off the gas burners

Turn burner control knob to off position (top).

### Flame failure device (model dependant)

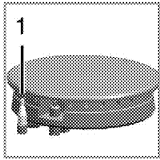

1 . Flame failure device

In case of any flame failures for any reasons in the top burners, the flame failure device immediately cuts of the gas flow.

- Turn the knob clockwise direction by pressing and wait for its ignition.
- Keep the knob at pressed position for 3-5 seconds after you see the flame around the burner.
- Repeat the sequence of operations if the flame does not continues. After you release the knob, if the ignition does not continue repeat the same process by keeping the knob pressed for 15 seconds.



### DANGER

#### Risk of deflagration incase of unburned gas!

Do not press the knob for longer than 15 seconds if there was no ignition.  
Wait for one minute and then repeat the ignition process.

---

## 6 How to Operate the Oven

---

### General information on baking, roasting and grilling

---



#### **DANGER**

#### **Risk of scalding by hot steam!**

Take care when opening the oven door as steam may escape.

---

#### **Tips for baking**

- Use non-stick coated appropriate metal plates or aluminum containers or heat-resistant silicone moulds.
- Make best use of the space on the rack.
- It is recommended to place the baking mould in the middle of the rack.
- Select the correct shelf position before turning the oven or grill on - don't move oven shelves when hot.
- Keep the oven door closed.

#### **Tips for roasting**

- Seasoning with lemon juice and black pepper will improve the cooking performance when cooking a whole chicken, turkey or a large piece of meat.
- Meat with bones takes about 15 to 30 minutes longer before it is cooked than a roast of the same size without bones.
- You should calculate about 4 to 5 minutes cooking time per centimeter height of the meat.
- Let meat rest in the oven for about 10 minutes after the cooking time. The juice is better distributed all

over the roast and does not run out when the meat is cut.

- Fish in a fire-resistant dish should be placed on the rack at the medium or lower level.

#### **Tips for grilling**

Grilling is ideal for cooking meat, fish and poultry and will achieve a nice brown surface without it drying out too much. Flat pieces, meat skewers and sausages are particularly suited for grilling as are vegetables with a high water content such as tomatoes and onions.

- Distribute the pieces to be grilled on the wire shelf.
- If the grilling is on the wire shelf, locate a dripping pan under it in order to collect the fat.
- Add some water in dripping pan for easy cleaning.

## How to use the gas oven



### Important

The appliance has a safety valve. When the flame goes out, the gas supply is automatically interrupted. So an accumulation of unburnt gas is prevented.

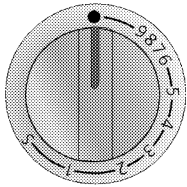

The gas oven is operated by the gas oven control knob. In off position (top) the gas supply is locked.

### Switch on the gas oven

The gas oven is ignited with the ignition button.

1. Open oven door.
2. **Keep** gas oven control knob **pressed** and turn it counterclockwise.
3. Press ignition button and release it again.
  - » Repeat the process until the emanating gas is ignited.
4. Keep the gas oven control knob pressed for another 3 to 5 seconds.
5. Be sure that gas has ignited and flame is present.
6. If there is no electricity; ignite the gas with the gas lighter from the ignition control hole.

7. Select the desired baking power.

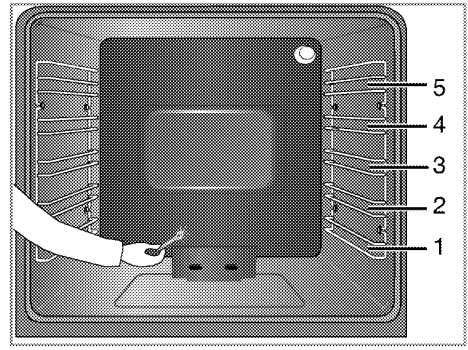

### DANGER

**Risk of deflagration by gas that is not ignited!**

"The device shall not be operated for more than 15 s. If after 15 s the burner has not lit, stop operating the device and open the compartment door and/or wait at least 1 min before attempting a further ignition of the burner."

### Switch off the gas oven

1. Turn gas oven control knob to off position (top).

### “S” Slow cooking

“S” is a low temperature setting.

Before “S” setting; when roasting joints, poultry or pot roasting, always cook at mark 6 for 30 minutes at the beginning of the cooking period.

The gas levels mean:

Gas level	S	1	2	3	4	5	6	7	8	9
Temperature in °C	105 – 120	135	150	160	175	190	200	220	230	240
Temperature in °F	225 – 250	275	300	325	350	375	400	425	450	460

## Cooking times table

### **i** Important

The values indicated in the table below are data indicative. They may vary according to the type of food as well as your preferences of cooking.

### **i** Important

Level 1 is the **bottom** level in the oven.

### **!** NOTICE

Maximum load for the oven tray:  
4 kg (8,8 lbs).

## Baking and roasting

Food	Preheating *	Insertion level	Control knob position	Cooking time
Roast beef	10 min.	3...4	5...6	25...30 min. per 450 g + 30 min.
Roast lamb	10 min.	3...4	5...6	25...30 min. per 450 g + 30 min.
Roast pork	10 min.	3...4	5...6	30...35 min. per 450 g + 30 min.
Poultry	10 min.	5	5...6	25...30 min. per 450 g + 25 min.
Casseroles	-	4	2...3	90...120 min. <sup>§</sup>
Fruit cake	10 min.	2...3	2...3	..... <sup>#</sup>
Small cakes	10 min.	4	4...5	25...30 min.
Victoria sandwich	10 min.	3	4...5	22...28 min.

\* at control knob position 7 / <sup>§</sup> depending on quantity / <sup>#</sup> depending on size

## How to operate the gas grill- Top oven

### **i** Important

The appliance has a safety valve. When the flame goes out, the gas supply is automatically interrupted. So an accumulation of unburnt gas is prevented.

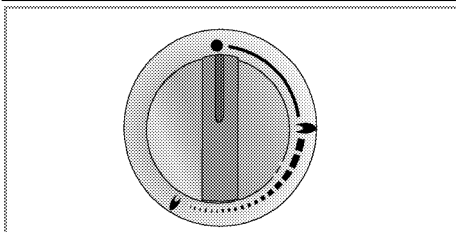

The grill is operated by the grill control knob. In off position (top) the gas supply is locked.

During grill operation, the oven door must remain open.

**The door has a door switch.** As a safety feature, this switch prevents the grilling when the door is closed.

When the door is open, grill switch is on, the grill burner can be activated. When the door is closed, the grill can not be activated

### Switch on grill

The gas grill is ignited with the ignition button.

1. Open oven door.

2. Keep grill control knob **pressed** and turn it in **clockwise** onto the grill symbol.
3. Press ignition button and release it again.
  - » Repeat the process until the gas is ignited.
4. Keep the grill control knob pressed for another 3 to 5 seconds.
5. Be sure that ignited and flame occurred.
6. If there is no electricity; ignite the gas with the gas lighter direct to grill burner.

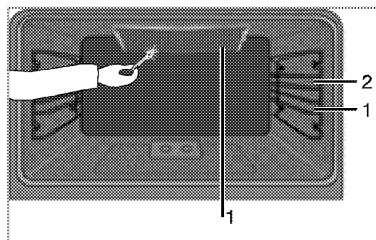

1 Grill burner

### Switch off grill

1. Turn grill control knob to off position (top).

### Cooking times table



#### **DANGER**

**Risk of deflagration by gas that is not ignited!**

"The device shall not be operated for more than 15 s. If after 15 s the burner has not lit, stop operating the device and open the compartment door and/or wait at least 1 min before attempting a further ignition of the burner."



#### **Important**

The values indicated in the table below are data indicative. They may vary according to the type of food as well as your preferences of cooking.



#### **Important**

Level 1 is the **bottom** level in the oven.



#### **NOTICE**

Do not use the upper level for grilling.

<b>Food</b>	<b>Preparation/setting</b>	<b>Grilling time <sup>#</sup></b>
Toasting of bread products	.....	3...10 min.
Small cuts of meat, sausages, bacon, etc.	.....	15...20 min.
Chops, gammon steaks, chicken pieces, etc.	Chicken with wire rack in upturned position.	20...25 min.
Whole fish, fish fillets, fish fingers	Whole fish and fish fillets placed in the base of the grill pan.	10...20 min.
Fish in breadcrumbs	.....	15...20 min.
Pre-cooked potato products	.....	15...20 min.
Pizza	Placed in the base of the grill pan.	12...15 min.
Grilling/browning of food	Dish placed directly on the base of the grill compartment.	8...10 min.

<sup>#</sup> depending on size resp. thickness



## 7 Maintenance and Care

---

### General information

---



#### **DANGER**

##### **Risk of electric shock!**

Switch off the electricity before cleaning appliance to avoid an electric shock.

---



#### **DANGER**

##### **Hot surfaces may cause burns!**

Allow the appliance to cool down before you clean it.

---



#### **NOTICE**

The surface might get damaged by some detergents or cleaning materials.

Do not use aggressive detergents, cleaning powder/cream or any sharp objects.

---

Clean the appliance thoroughly after each use; in this way it will be possible to remove cooking residues more easily, thus avoiding these from burning the next time the appliance is used.

No special cleaning agents are required for cleaning the appliance. It is recommended to use warm water with washing liquid, a soft cloth or sponge and use a dry cloth for drying.

**Do not use any abrasive cleaning materials!**

---



#### **Important**

Do not use steam cleaners for cleaning.

---

### How to clean the hob

#### **Gas hobs**

1. Remove pan supports and burner caps and clean them.
2. Clean the hob.
3. Refit burner caps and check that they are securely positioned.
4. While placing pan supports, take care that burners centered to pan supports.

### Cleaning the control panel

---



#### **NOTICE**

Damage of the control panel!  
Do not remove the control knobs for control panel cleaning.

---

Clean control panel and control knobs.

### Cleaning the oven

No oven cleaner or any other special cleaning agent is required for cleaning the oven. It is recommended to wipe the oven with a damp cloth while it is still warm.

#### **Clean oven door**

Don't use any harsh abrasive cleaners or sharp metal scrapers for cleaning the oven door. They could scratch the surface and destroy the glass.

## Replacing the oven lamp

---



### **DANGER**

#### **Hot surfaces may cause burns!**

Make sure that the appliance is switched off and cooled down in order to avoid the risk of an electrical shock.

---

The oven lamp is a special heat-resisting (T 300 °C) electric light bulb; see *Technical Data, page 5*. Oven lamps can be obtained from a good local electrical store.

---



### **NOTICE**

Position of lamp might vary from diagram.

---

1. Switch off the appliance at the mains.
2. Unscrew glass cover by turning anti-clockwise.

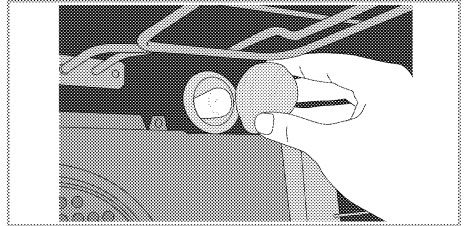

3. Unscrew oven lamp by turning anti-clockwise and replace it with new one.
4. Refit the glass cover.

## 8 Troubleshooting



### DANGER

**Risk of electric shock, short circuit or fire by unprofessional repairs!**

Repairs on the appliance must be carried out by an approved service centre.



### DANGER

**Risk of explosion or poisoning by unprofessional repair.**

Repairs on the appliance must be carried out by an approved service centre.

### Normal operating conditions

- Smoke and smell may emit for a couple of hours during the first operation.
- It is normal that steam escapes during operation.
- When the metal parts are heated, they may expand and cause noise.

**Before you call the service, please check the following points.**

### Electrical equipment

Malfunction/problem	Possible cause	Advice/remedy
The appliance does not work.	The mains fuse is defective or has tripped.	Check fuses in the fuse box. If necessary, replace or reset them.
Oven light does not work	Oven lamp is defective.	Replace oven lamp.
	No current.	Check fuses in the fuse box. If necessary, replace or reset them.
Oven does not heat.	Function knob and/thermostat knob are not set.	Set function knob and thermostat knob.
	If the appliance has a timer, the timer may not be set.	Set the time.
	No power.	Check mains supply and fuse box.

### Gas

Malfunction/problem	Possible cause	Advice/remedy
No ignition spark is produced.	No electric supply to the appliance.	Check fuses in the fuse box.
No gas is emitted.	Main gas tap is closed.	Open gas tap.
	Safety tube is bent.	Install safety tube without bends.
Burners do not burn smoothly or not at all.	Burners are dirty.	Clean burner parts.
	Burners are not dry.	Dry burner parts.

Malfunction/problem	Possible cause	Advice/remedy
	Burner cap is not securely positioned.	Position burner correctly.
	Gas tap is closed.	Open gas tap.
	Gas container is empty (in case of LPG connection).	Replace gas container.

If the problem has not been solved:

1. Separate unit from the mains supply (deactivate or unscrew fuse). Call the appropriate telephone number for your area as shown in the

Guarantee and Service section of this user manual.



**Important**

Do not attempt to repair the appliance yourself. There are no customer service items inside the appliance.

## 9 Guarantee and Service

Your Beko product is guaranteed against the cost of breakdown repairs for twelve months from the date of the original purchase.

### What is covered?

- All repairs necessary as a result of faulty materials, defective components or manufacturing defect.
- The cost of all functional replacement parts.
- The labour costs of a Beko approved repairer to carry out the repair.

### What is not covered?

- Transit or delivery damage
- Accidental damage
- Misuse, or abuse.
- Cabinet or appearance parts, including knobs and flaps
- Accessory items, including ice trays, scrapers, cutlery baskets,
- Repairs required as a result of unauthorised repairs or inexpert installation that fails to meet the requirements contained in the user instruction book.

Repairs to products used on commercial or non-residential household premises.

### Important notes.

- The product is guaranteed for domestic household use only.
- The guarantee will be void if the product is installed or used in commercial or non-residential household premises.
- The product must be correctly installed, located and operated in accordance with the instructions contained in the User Instructions Booklet provided.
- Professional Installation by a qualified plumber/electrical appliance installer is recommended for all Washing & Dishwashing Machines and Electric Cookers
- Gas appliances must only be installed by a Gas Safe (or BORD GAS) registered Gas Installer.
- The guarantee is given only within the boundaries of the United Kingdom.
- The guarantee is not transferable if the product is resold.
- Beko plc disclaims any liability for incidental or consequential damages.
- The guarantee does not in anyway diminish your statutory or legal rights.

## HOW TO OBTAIN SERVICE UNDER THE MANUFACTURERS WARRANTY

Please keep your purchase receipt or other proof of purchase in a safe place; you will need to have it should the product require attention in the guarantee period

You should also complete the details below; it will help us assist you quicker when requesting service. (The model number is printed on the Instruction Booklet)

Model Number: \_\_\_\_\_

Purchased From: \_\_\_\_\_

Date of purchase: \_\_\_\_\_

For service under guarantee simply telephone the appropriate number below  
UK Mainland & Northern Ireland

Fridges & Freezers	0845 600 4903
Electric Cookers	0845 600 4902
Gas & Dual Fuel Cookers	0845 600 4905
Washing Machines & Dishwashers	0845 600 4906

Republic of Ireland

All Refrigeration, Cooking, Washing & Dishwashing Machines 01 862 3411

Before requesting service please check the trouble-shooting guide in the Operating instructions as a charge may be levied where no fault is found even though your product may still be under guarantee.

If you have purchased an extended guarantee please refer to the instructions contained within the extended guarantee agreement document. Otherwise please call the above numbers where service can be obtained at a charge.

Service once the manufacturers guarantee has expired.

Should you experience any difficulty in obtaining service please call the

**Beko Customer Help-Line on 0845 600 4911**

**Beko House, Caxton Way, Watford, Herts, WD18 8UF, Tel: 0845 600 4911**





Beko plc  
Beko House  
Caxton Way  
Watford  
Herts WD1 8UF  
Tel: 0845 6004904

Printed in Turkey  
Part no: 285.9205.80  
Rev: A.A/ 11.03.2010