

# Dryer

## User Manual

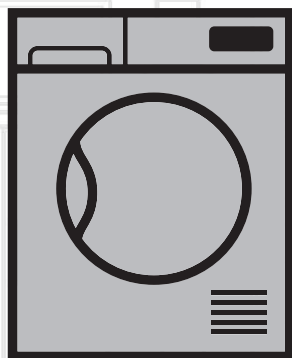

DTBP 8001 W  
DTBP 8001 A  
DTGP 8000 W

EN

2960311755/241018.1140

CE

**beko**

## Please read these instructions first before using your appliance

Thank you for choosing a Beko appliance. Please take some time to read this user manual before using your appliance, to ensure you know how to safely operate the controls and functions.

Carefully follow all unpacking and installation instructions to ensure the appliance is correctly connected and fitted prior to use.

Please write your product model and serial number on the last page of this user manual, and store in a safe location close to the appliance for easy future reference.

This user manual may also be applicable for several other models. Differences between models will be listed.

If you have any questions or concerns, please call our contact centre or find help and information online at [www.beko.co.uk](http://www.beko.co.uk)

## Explanation of symbols used throughout this User Manual



- Read the instructions.



### DANGER!

- Warning against electric shock.



### DANGER!

- Warning against fire hazard.



### WARNING!

- Warning for hazardous situations with regard to life and property.



### WARNING!

- Warning against hot surfaces.



### WARNING!

- Warning against scalding hazard.



### NOTE

- Important information or useful hints about usage.



Packaging materials of the product are manufactured from recyclable materials in accordance with our National Environment Regulations.

Do not dispose of the packaging wastes with the domestic waste or other wastes, discard them to the dedicated collection points designated by the local authorities.



This product was manufactured using the latest technology in environmentally friendly conditions.

# 1 Important instructions for safety and environment



## NOTE

- This section contains safety instructions that will help protect from risk of personal injury or property damage. Failure to follow these instructions shall void any warranty.

## 1.1 General safety



### WARNING!

The dryer can be used by children at and above 8 years old and by persons whose physical, sensory or mental capabilities were not fully developed or who lack experience and knowledge provided that they are supervised or trained on the safe usage of the product and the risks it brings out. Children should not play with the product. Cleaning and maintenance works should not be performed by children unless they are supervised by someone. Children of less than 3 years should be kept away unless continuously supervised.

- Adjustable feet should not be removed. The gap between the dryer and the floor should not be reduced with materials such as carpet, wood and tape. This will cause problems with the dryer.



### WARNING!

Always have the installation and repairing procedures carried out by the Authorized Service. Manufacturer shall not be held liable for damages that may arise from procedures carried out by unauthorized persons.

- Never wash the dryer by spraying or pouring water onto it! There is the risk of electric shock!

### For the products with a steam function:



### WARNING!

- Use only distilled water or water condensed in the water tank of the machine in steam programs. Do not use mains water or additives. When using condensed water in the water tank, it should be filtered and cleared of fibres.
- Do not open the door when steam programs are running. Hot water may be expelled.
- Before putting laundry in a steam program, stains on it should be removed.
- You may only put laundry that is not dirty or stained but permeated with unpleasant odour in steam (odour removal) program.
- Do not use any dry cleaning sets or additional materials in a steam program or in any program.

## 1.1.1 Electrical safety



### DANGER!

- Electrical safety instructions should be followed while electrical connection is made during the installation.
- The appliance must not be supplied through an external switching device, such as a timer, or connected to a circuit that is regularly switched on and off by utility.
- Connect the dryer to a grounded outlet protected by a fuse at the value specified on the type label. Have the grounding installation performed by a qualified electrician. Our company shall not be liable for any damages that will arise when the dryer is used without grounding in accordance with the local regulations.
- The voltage and allowed fuse protection is stated on the type label plate.
- The voltage specified on the type label must be equal to your mains voltage.
- Unplug the dryer when it is not in use.
- Unplug the dryer from the mains during installation, maintenance, cleaning and repair works.
- Do not touch the plug with wet hands! Never unplug by pulling on the cable, always pull out by grabbing the plug.



### DANGER!

- Do not use extension cords, multi-plugs or adaptors to connect the dryer to power supply in order to decrease the risk of fire and electric shock.
- Power cable plug must be easily accessible after installation.
- Damaged mains cable should be changed notifying the Authorized Service.
- If the dryer is faulty, it must not be operated unless it is repaired by an authorized service agent! There is the risk of electric shock!

## 1.1.2 Product safety



### DANGER!

- Superheating of the clothes inside of the dryer can occur if you cancel the programme or in the event of a power failure whilst the dryer is running, this concentration of heat can cause self-combustion and fire so always activate the ventilation programme to cool down or quickly remove all laundry from the dryer in order to hang them up and dissipate the heat.



## DANGER!

### Points to be taken into consideration for fire hazard:

Below specified laundry or items must not be dried in the dryer considering fire hazard.

- Unwashed laundry items
- Items soiled with oil, acetone, alcohol, fuel oil, kerosene, stain removers, turpentine, paraffin or paraffin removers must be washed in hot water with plenty of detergent before being dried in the dryer.

For this reason especially the items containing the above specified stains must be washed very well, to do this use adequate detergent and choose a high washing temperature.

### Below specified laundry or items must not be dried in the dryer due to the fire hazard:

- Garments or pillows bolstered with rubber foam (latex foam), shower bonnets, water resistant textiles, materials with rubber reinforcement and rubber foam pads.

Clothing cleaned with industrial chemicals.

Items such as lighter, match, coins, metal parts, needle etc. may damage the drum set or may lead to functional problems. Therefore check all the laundry that you will load into your dryer.

Never stop your dryer before the programme completes. If you must do this, remove all laundry quickly and lay them out to dissipate the heat.



## DANGER!

- Clothes that are washed inadequately may ignite on their own and even may ignite after drying ends.
- You must provide enough ventilation in order to prevent gases exiting from devices operating with other types of fuels including the naked flame from accumulating in the room due to the back fire effect.



## WARNING!

- Underwear that contains metal reinforcements should not be dried in the dryer. Dryer may be damaged if metal reinforcements come loose and break off during drying.



## NOTE

- Use softeners and similar products in accordance with the instructions of their manufacturers.

Always clean the lint filter before or after each loading. Never operate the dryer without the lint filter installed.



## WARNING!

- Never attempt to repair the dryer by yourself. Do not perform any repair or replacement procedures on the product even if you know or have the ability to perform the required procedure unless it is clearly suggested in the operating instructions or the published service manual. Otherwise, you will be putting your life and others' lives in danger.
- There must not be a lockable, sliding or hinged door that may block the opening of the loading door in the place where your dryer is to be installed.
- Install your dryer at places suitable for home use. (Bathroom, closed balcony, garage etc.)
- Make sure that pets do not enter the dryer. Check the inside of the dryer before operating it.
- Do not lean on the loading door of your dryer when it is open, otherwise it may fall over.
- The lint must not be allowed to accumulate around the tumble dryer
- The tumble dryer is not to be used if industrial chemicals have been used for cleaning.
- Fabric softeners, or similar products, should be used as specified by the fabric softener instructions.
- Exhaust air must not be discharged into a flue which is used for exhausting fumes from appliances burning gas or other fuels.

## 1.2 Mounting over a washing machine

- A fixing device should be used between the two machines when installing the dryer above a washing machine. The fitting device must be installed by the authorized service agent.
- Total weight of the washing machine and the dryer -with full load- when they are placed on top of each other reaches to approx. 180 kilograms. Place the products on a solid floor that has sufficient load carrying capacity!



## WARNING!

- Washing machine cannot be placed on the dryer. Pay attention to the above warnings during the installation on your washing machine.

Installation Table for Washing Machine and Dryer

Dryer Depth	Washing Machine Depth				
	62 cm	60 cm	54 cm	50 cm	49 cm
54 cm	Can be installed				
60 cm	Can be installed				

Installation Table for Washing Machine and Dryer

Dryer Depth	Washing Machine Depth	
	45 cm	40 cm
54 cm	Can be installed	Cannot be installed
60 cm	Can be installed	

## 1.3 Intended use

- Dryer has been designed for domestic use. It is not suitable for commercial use and it must not be used out of its intended use.
- Use the dryer only for drying laundry that are marked accordingly.
- The manufacturer waives any responsibility arisen from incorrect usage or transportation.
- The service life of the dryer that you purchased is 10 years. During this period, original spare parts will be available to operate the dryer properly.

## 1.4 Child safety

- Packaging materials are dangerous for the children. Keep packaging materials away from children.
- Electrical products are dangerous for the children. Keep children away from the product when it is operating. Do not let them tamper with the dryer. Use the child-proof lock in order to prevent the children to tamper with the dryer.



### NOTE

Child-proof lock is on the control panel.  
(See Child lock)

- Keep loading door closed even when the dryer is not in use.

## 1.5 Compliance with the WEEE regulation and disposing of the waste product



This product complies with EU WEEE Directive (2012/19/EU). This product bears a classification symbol for waste electrical and electronic equipment (WEEE).

This product has been manufactured with high quality parts and materials which can be reused and are suitable for recycling. Do not dispose of the waste product with normal domestic and other wastes at the end of its service life. Take it to the collection center for the recycling of electrical and electronic equipment. Please consult your local authorities to learn about these collection centers.

## 1.6 Compliance with RoHS Directive:

The product you have purchased complies with EU RoHS Directive (2011/65/EU). It does not contain harmful and prohibited materials specified in the Directive.

## 1.7 Package information

Packaging materials of the product are manufactured from recyclable materials in accordance with our National Environment Regulations. Do not dispose of the packaging materials together with the domestic or other wastes. Take them to the packaging material collection points designated by the local authorities.

## 1.8 Technical Specifications

EN

Height (Min. / Max.)	84,6 cm / 86,6 cm*
Width	59,7 cm
Depth	56,8 cm
Capacity (max.)	8 kg**
Net weight (± 4 kg)	44 kg
Voltage	See type label***
Rated power input	
Model code	

\* Min. height: Height with adjustable feet are closed.

Max. height: Height with adjustable feet are opened maximum.

\*\* Dry laundry weight before washing.

\*\*\* Type label is located behind the loading door.



### NOTE

- Technical specifications of the dryer are subject to specification without notice to improve the quality of the product.
- Figures in this manual are schematic and may not match the product exactly.
- Values stated on markers on the dryer or in the other published documentation accompanying with the dryer are obtained in laboratory in accordance with the relevant standards. Depending on operational and environmental conditions of the dryer, these values may vary.





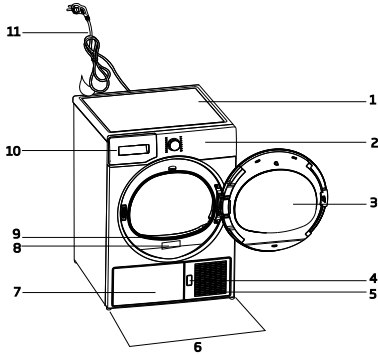

## 2 Your Dryer

### 2.1 Overview

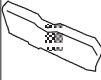
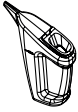

1. Top panel
2. Control panel
3. Loading door
4. Kick plate opening button
5. Ventilation grids
6. Adjustable legs
7. In models where the tank is placed below, the water tank is inside the toe board
8. Type label
9. Lint filter
10. Water tank drawer (in models where the tank is placed above)
11. Power cord

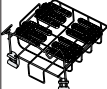
### 2.2 Package Contents

	1. Water drain hose *		5. Drying basket user manual*
	2. Filter drawer spare sponge*		6. Water Filling Container*
	3. User Manual		7. Pure Water*
	4. Drying basket*		8. Fragrance Capsules Group*

\*It can be supplied with your machine depending on its model.

## 3 Installation

Before the calling the nearest Authorized Service for the installation of the dryer, ensure that electrical installation and water drain is appropriate referring to the user's manual. If they are not suitable, contact a qualified electrician and technician to make necessary arrangements.



### NOTE

- Preparation of the dryer's location as well as the electrical and waste water installations is under customer's responsibility.



### WARNING!

- Prior to installation, visually check if the dryer has any defects on it. If the drier is damaged, do not have it installed. Damaged products cause risks for your safety.
- Let your dryer wait for 12 hours before starting to use it.

### 3.1 Appropriate installation location

Install the dryer on a stable and level surface. Dryer is heavy. Do not move it by yourself.

- Operate your dryer in a well ventilated, dust-free environment.
- The gap between the dryer and the surface should not be reduced by the materials such as carpet, wood and tape.
- Do not cover the ventilation grills of the dryer.
- There must not be a lockable, sliding or hinged door that may block the opening of the loading door in the place where your dryer is to be installed.
- Once the dryer is installed, it should stay at the same place where its connections have been made. When installing the dryer, make sure that its rear wall does not touch anywhere (tap, socket, etc.).
- Place the dryer at least 1 cm away from the edges of other furniture.
- Your dryer can be operated at temperatures between +5°C and +35°C. If the operating conditions fall outside of this range, operation of the dryer will

be adversely affected and it can get damaged.

- The rear surface of the tumble dryer shall be placed against a wall.



## DANGER!

Do not place the dryer on the power cable.

### 3.2 Removing the transportation safety assembly



## WARNING!

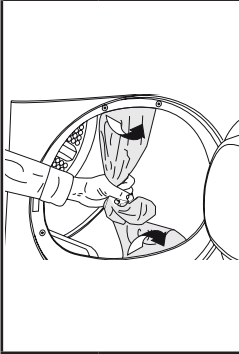

- Remove the transportation safety assembly before using the dryer for the first time.
- If the door swing side of your appliance can be modified, see the reversible door mounting instructions.

### 3.3 Connecting to the drain

You can directly drain accumulated water through the water drain hose supplied with the product instead of periodically draining the water collected in the water tank.

#### Connecting the water drain hose

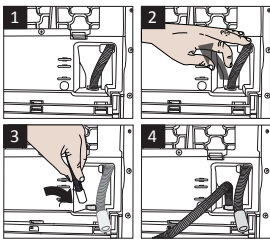

1-2 Pull hose at the behind of the dryer by hand in order to disconnect it from where it is connected. Do not use any tools to remove the hose.

- 3 Connect one end of the drain hose supplied with the dryer to the connection point from where you removed the hose of the product in previous step.
- 4 Connect the other end of the drain hose directly to the wastewater drain or to the washbasin.



## NOTE

- Water drain hose should be attached to a height of maximum 80 cm.
- Make sure that the water drain hose is not stepped on and it is not folded between the drain and the machine.
- If there is an accessories pack supplied with your product, please see the detailed description.

### 3.4 Adjusting the feet

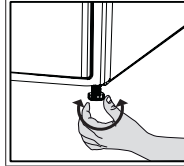

- Turn the feet to left or right until the dryer stands level and firmly.

### 3.5 Transportation of the dryer

Drain all water that has remained in the dryer. If direct water drain connection is made, then remove the hose connections.



## WARNING!

- We recommend carrying the dryer in upright position. If it is not possible to carry the machine in the upright position, we recommend carrying it by tilting towards the right side when looked from the front.

### 3.6 Warnings about sounds



## NOTE

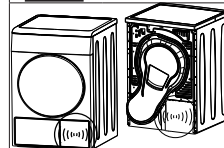

- It is normal to hear a metallic noise from the compressor sometimes during operation.
- Water collected during operation is pumped to water tank. It is normal to hear pumping noise during this process.

### 3.7 Changing the illumination lamp

In case an illumination lamp is used in your laundry dryer. To change the Bulb/LED used for illumination of your tumble dryer, call your Authorized Service. The lamp(s) used in this appliance is not suitable for household room illumination. The intended purpose of this lamp is to assist the user to place laundry in the tumble dryer in a comfortable way. The lamps used in this appliance have to withstand extreme physical conditions such as vibrations and temperatures above 50 °C

## 4 Preparation

### 4.1 Laundry suitable for drying in the dryer

Always obey the instructions given on the garment tags. Dry only the laundry having a label stating that they are suitable for drying in a dryer and make sure that you select the appropriate programme.

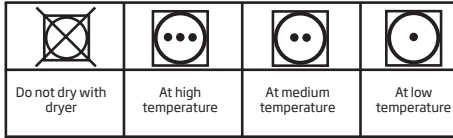

### 4.2 Laundry not suitable for drying in the dryer

	<b>NOTE</b>
<ul style="list-style-type: none"> <li>Delicate embroidered fabrics, woollen, silk garments, delicate and valuable fabrics, airtight items and tulle curtains are not suitable for machine drying.</li> </ul>	

### 4.3 Preparing laundry for drying

- Laundry may be tangled with each other after washing. Separate the laundry items before placing them into the dryer.
- Dry garments having metal accessories such as zippers, inside out.
- Fasten the zippers, hooks and buckles and button sheets.

### 4.4 Things to be done for energy saving

- Spin your laundry at the highest speed possible when washing them. Thus, the drying time is shortened and energy consumption is reduced.
- Sort out the laundry depending on their type and thickness. Dry the same type of laundry together. For example thin kitchen towels and tablecloths dries earlier than thick bathroom towels.
- Follow the instructions in the user manual for programme selection.
- Do not open the loading door of the machine during drying unless necessary. If you must open the loading door, do not keep it open for a long time.

- Do not add wet laundry while the dryer is in operation
- For models with a condenser unit: clean the condenser once in a month or after every 30 operations regularly. .
- Clean the filter periodically when there is visible air collection on it or when the symbol lights up, if there is a filter drawer cleaning warning symbol available.
- For models with flue unit: comply with the flue connection instructions and clean the flue.
- During the drying process, air the room well where your tumble dryer is operating.

### 4.5 Correct load capacity

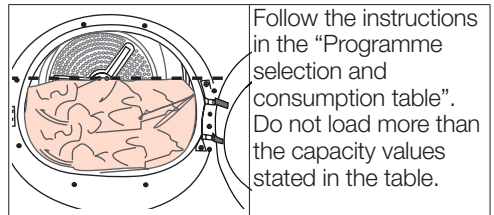

Following weights are given as examples.

Laundry	Approximate weights (g)*	Laundry	Approximate weights (g)*
Cotton quilt covers (double)	1500	Blouses	150
Cotton quilt covers (single)	1000	Cotton shirts	300
Bed sheets (double)	500	Shirts	250
Bed sheets (single)	350	Cotton dresses	500
Large tablecloths	700	Dresses	350
Small tablecloths	250	Jeans	700
Tea napkins	100	Handkerchiefs (10 pieces)	100
Bath towels	700	T-Shirts	125
Hand towels	350		

\*Dry laundry weight before washing.

## 5 Operating the product

### 5.1 Control Panel

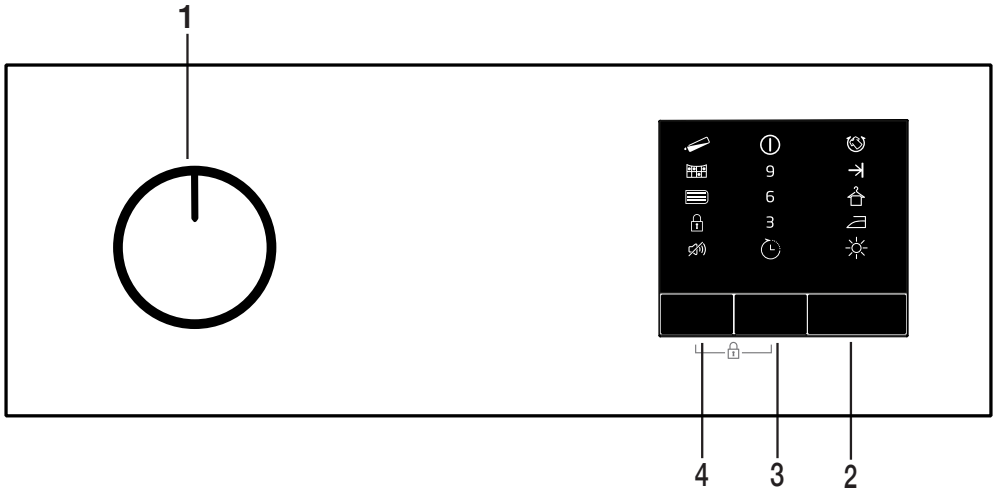

1. On/Off/Programme selection button
2. Start/Pause button

3. End Time button
4. Audio warning level button

### 5.2 Symbols



### 5.3 Preparation of drying machine

- Plug the drying machine.
- Open the loading door.
- Place the laundry to the drying machine without jamming them.
- Push and close the loading door.

Select the desired programme using the On/Off/Programme selection knob, the machine will turn on.

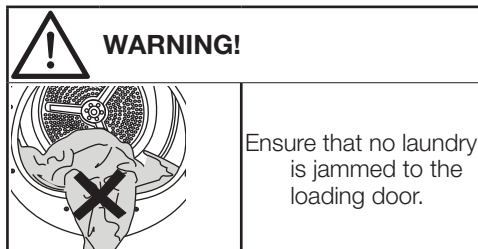

#### NOTE

- Selecting a programme using the On/Off/Programme selection button does not mean that the programme started. Press the Start / Stand-by button to start the programme.

## 5.4 Programme selection and consumption table

EN				
Programmes	Programme Description	Capacity (kg)	Spin speed in washing machine (rpm)	Drying Time (minutes)
Cotton Iron Dry	You may dry your cotton laundry to be ironed in this programme to have them slightly damp for ease of ironing. (Shirt, T-shirt, tablecloth, etc.)	8	1000	145
Cotton Eco	You may dry all your cotton laundry in this programme. (T-shirt, pants, pyjamas, baby clothes, underwear, linen, etc.) You can put your laundry in the wardrobe without ironing.	8	1000	197
Cotton Cupboard Dry	You may use this programme for extra dryness in thick laundry such as pants, tracksuit. You can put your laundry in the wardrobe without ironing.	8	1000	205
Cotton Extra Dry	You may dry your thick cotton laundry in this programme such as towels, bathrobe, etc. You can put your laundry in the wardrobe without ironing.	8	1000	210
Synthetic Iron Dry	You may dry your synthetic laundry to be ironed in this programme to have them slightly damp for ease of ironing. (Shirt, T-shirt, tablecloth, etc.)	4	800	60
Synthetic Cupboard Dry	You may dry all your synthetic laundry in this programme. (Shirt, T-shirt, underwear, tablecloth, etc.) You can put your laundry in the wardrobe without ironing.	4	800	70
Sport	You may dry your sports clothes that are appropriate for tumble drying in this programme.	4	1000	135
Freshen up	It just provides airing for 10 minutes without any hot air. You can air the cotton and linen laundry that have been stored for a long time, and eliminate the odour in them.	-	-	10
Time Programmes	You may select from time programmes between 30 and 60 minutes to achieve the desired drying level at low temperature. In this programme, tumble drier's operation lasts for the set time independently from the dryness of laundry.	-	-	-
Mix	Use this programme to dry non-pigmenting synthetic and cotton laundry items together.	4	1000	95
Babyprotect	Program used for baby clothing with can be dried approval on the label.	3	1000	85
Jeans	You may dry denim pants, skirts, shirts or jackets in this programme.	4	1200	150
Gentle Care	It dries the shirts in a more sensitive manner, and causes less creasing and easier ironing.	2	600	60
Express Super Short	Dries shirts more delicately and thus causes less wrinkles for easy ironing.	0,5	1200	30

Energy consumption values				
Programmes	Capacity (kg)	Spin speed in washing machine (rpm)	Approximate amount of remaining humidity	Energy consumption value kWh
Cotton cupboard dry*	8	1000	60%	2,47
Cotton Iron dry	8	1000	60%	2,1
Synthetic cupboard dry	4	800	40%	0,80
Contains fluorinated greenhouse gases covered by the Kyoto Protocol. R450a / 0,20 kg - GWP:604 - 0,121 tCO2e Hermetically sealed.				
	"Cotton Eco programme" used at full and partial load is the standard drying programme to which the information in the label and the fiche relates, that this programme is suitable for drying normal wet cotton laundry and that it is the most efficient programme in terms of energy consumption for cotton.			

\* : Energy Label standard programme (EN 61121:2012)

All the values on the chart are identified according to EN 61121:2012 standard. Consumption values may vary from the values in the chart depending on laundry type, wringing speed, ambient conditions and voltage levels.

## 5.5 Auxiliary functions

### Audible warning

Drying machine makes an audible warning when the programme is completed. If you don't want it to make an audible warning, press the "Buzzer" button. When you press the Buzzer button, a light will illuminate and no audible warning will be made when the programme ends.



### NOTE

- You can select this function before or after the programme starts.

### End time

If you prefer to dry your laundry at a later time, you can delay start time of the programme up to 3 hours, 6 hours or 9 hours using the Delay function.

Open the loading door and place the laundry.

Select the drying programme.

Press the End Time selection button and set the delay time you wish. When the End Time button is pressed once, 3 hours delay is selected and the delay indicator will light up.

If you press the same button again, 6 hours delay will be selected and when you press for the third time, 9 hours delay will be selected. If you press the End Time button once again, the delay will be cancelled.

After the End Time selection is made, start delayed running for the programme selected pressing the "Start/Stand-by" button.



## NOTE

- You can add or remove laundry within end time. At the end of the Time Delay countdown, the Time Delay warning indicator turns off and drying begins

### Changing the end time

If you want to change the duration during the countdown:

Cancel the programme by turning the On/Off/Programme selection knob. Select the programme you want and repeat the End Time selection process.

### Cancelling the end time function

If you want to cancel the end time countdown and start the programme immediately:

Cancel the programme by turning the On/Off/Programme selection knob. Select the programme you want and press the Start/Stand-by button.

## 5.6 Warning indicators



## NOTE

- Warning indicators may vary depending on the model of your dryer.

### Filter cleaning

When the programme is completed, the warning indicator for filter cleaning turns on.

### Water tank

If the water tank fills up while the programme continues, the warning indicator starts flashing and the machine goes into stand-by. In this case, empty the water tank and start the programme by pressing the Start / Stand-by button. Warning indicator turns off and programme resumes.

### Filter drawer /Heat exchanger cleaning

When the programme is finished, the cleaning symbol of the heat exchanger or filter drawer may light up.

## 5.7 Starting the programme

Press the Start/Stand-by button to start the programme.

Drying indicator will light up, indicating that the programme has started.

## 5.8 Child Lock

The drying machine has a child lock which prevents the programme flow from being interrupted when the buttons are pressed during a programme. When the child lock is activated, all buttons on the panel except the On/Off/Programme selection knob are deactivated.

Press the End Time and Buzzer buttons simultaneously for 3 buttons to activate the child lock.

The child lock has to be deactivated to be able to start a new programme after the current programme is finished or to be able to interfere with the programme. To deactivate the child lock, keep the same buttons pressed for 3 seconds.



## NOTE

- When the child lock is activated, the child lock warning indicator on the screen turns on.
- Child lock deactivates when the drying machine is turned off and on by the On/Off/Cancel knob.

When the child lock is active:

When the drying machine runs, or in stand-by state, the indicator symbols won't change upon changing the position of the programme selection knob.



## NOTE

- When the drying machine runs and the child lock is active, it beeps twice when the programme selection knob is turned. If the child lock is deactivated without returning the programme selection knob to its previous position, programme will terminate due to the change in the programme selection knob position.

## 5.9 Changing the programme after it is started

You can change the programme you selected to dry your laundry with a different programme after the drying machine starts running

- For instance, select Extra Dry programme by turning the On/Off/Programme selection knob to select Extra Dry instead of Iron Dry.
- Press the Start/Stand-by button to start the programme.

## Adding and removing clothes during stand-by

If you want to add or remove clothes to/from the drying machine after the drying programme starts:

- Press the Start/Stand-by button to put the drying machine in Stand-by state. The drying operation stops.
- Open the loading door while in Stand-by state, and close the door after you remove or add laundry.
- Press the Start/Stand-by button to start the programme.



### NOTE

- Adding laundry after the drying operation starts may cause the dried laundry inside the machine to mix with wet laundry and leave the laundry damp at the end of operation.
- Adding or removing laundry during drying may be repeated as many times as you wish. But this operation continuously interrupts the drying operation, and thus increases programme duration and energy consumption. So, it is recommended to add laundry before the programme starts.
- If a new programme is selected by turning the programme selection knob while the drying machine is in stand-by, the running programme terminates.

## 5.11 End of programme

When the program ends, the Last/Anti-Wrinkle and Fibre Filter Cleaning Warning LEDs on the program follow up indicator will illuminate. Loading door may be opened and the dryer machine becomes ready for another run. Bring the On/Off/Programme selection knob to On/Off position to turn the drying machine off.



### NOTE

- If the laundry is not removed after the programme is completed, the wrinkle prevention function activates for 2 hours to prevent the laundry inside the machine to get wrinkled. The programme tumbles the laundry with 10-minute intervals to prevent them from wrinkling.



### WARNING!

- Do not touch the inner surface of the drum while adding or removing clothes during a continuing programme. The drum surface is hot.

## 5.10 Cancelling the programme

If you want to cancel the programme and terminate the drying operation for any reason after the drying machine starts running, turn the On/Off/Cancel knob, the programme will be cancelled.



### WARNING!

- The inside of the drying machine shall be extremely hot when you cancel the programme during machine operation, so run the refresh programme to allow it to cool down.

## 6 Maintenance and cleaning

Service life of product extends and frequently experienced problems will be reduced if it is cleaned at regular intervals.



### WARNING!

- Please unplug your product before performing maintenance and cleaning instructions. (eg control panel, body, etc.)

### 6.1 Cleaning Lint Filter / Loading Door Inner Surface

Lint and fiber released from the laundry to the air during the drying cycle are collected in the Lint Filter.



### NOTE

- You can clean the lint filter housing with a vacuum cleaner.



### WARNING!

- Always clean the lint filter and the inner surfaces of the loading door after each drying process.

To clean the lint filter:

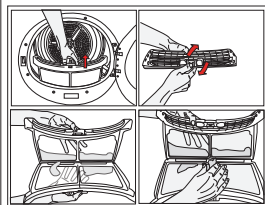

- Open the loading door.
- Remove the lint filter by pulling it up and open the lint filter.

- Clean lint, fiber, and cotton raveling by hand or with a soft piece of cloth.
- Close the lint filter and place it back into its housing.

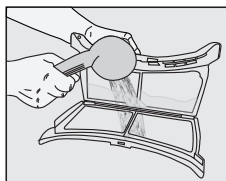

A layer can build up on the filter pores that can cause clogging of the filter after using the dryer for a while. Wash the lint filter with warm water to remove the layer that builds up on the lint filter surface. Dry the lint filter completely before reinstalling it.

- Clean the entire inner surface of the loading door and loading door gasket with a soft damp cloth.

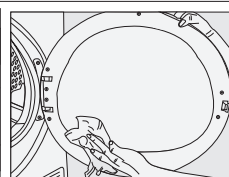
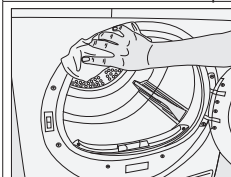

### 6.2 Cleaning the sensor

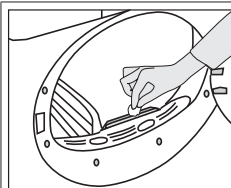

There are dampness sensors in the dryer that detect whether the laundry is dry or not. To clean the sensors:

- Open the loading door of the dryer.
- Allow the machine to cool down if it is still hot due to the drying process.
- Wipe the metal surfaces of the sensor with a soft cloth, dampened with vinegar and dry them.



### NOTE

- Clean metal surfaces of the sensors 4 times a year.
- Do not use metal tools when cleaning metal surfaces of the sensors.



### WARNING!

- Never use solvents, cleaning agents or similar substances for cleaning due to the risk of fire and explosion!

### 6.3 Draining the water tank

Dampness of the laundry is removed and condensed during drying process and the water that arise accumulates in the water tank. Drain the water tank after each drying cycle.

	<b>WARNING!</b>
<ul style="list-style-type: none"><li>• Condensed water is not drinkable!</li><li>• Never remove the water tank when the program is running!</li></ul>	

If you forget to drain the water tank, the machine will stop during the subsequent drying cycles when the water tank is full and the Water Tank warning symbol will flash. If this is the case, drain the water tank and press Start / Pause button to resume the drying cycle. To drain the water tank:

1. Remove the water tank in the drawer or container carefully.

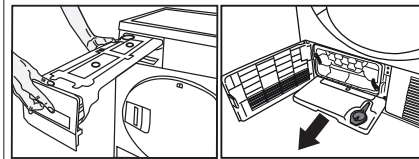

2. Drain the water in the tank.

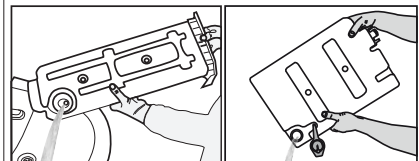

- If there is lint accumulation in the funnel of the water tank, clean it under running water.
- Place the water tank into its seat.

	<b>NOTE</b>
<ul style="list-style-type: none"><li>• If the direct water draining is used as an option, there is no need to empty the water tank.</li></ul>	

### 6.4 Cleaning the filter drawer

Lint and fiber that could not be captured by the lint filter are blocked in the filter drawer behind the kick plate. Clean the filter periodically when there is visible air collection on it or when the symbol lights up, if there is a filter drawer cleaning warning symbol available. There is an one stage filter. This one stage filter is from sponge

To clean the filter drawer:

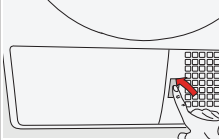
	<ul style="list-style-type: none"><li>• Press the kick plate button to open the kick plate.</li></ul>
-----------------------------------------------------------------------------------	-------------------------------------------------------------------------------------------------------

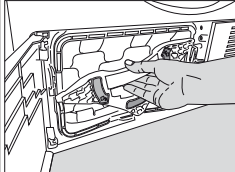
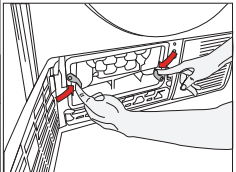
<ul style="list-style-type: none"><li>• Open the filter drawer cap turning the cap lock on it and pull it out..</li></ul>	
	

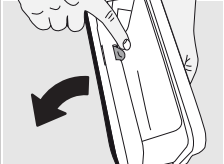
	<ul style="list-style-type: none"><li>• Open the filter drawer by pressing the red button.</li></ul>
-----------------------------------------------------------------------------------	------------------------------------------------------------------------------------------------------

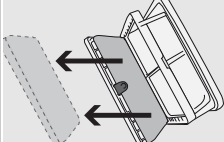
	<ul style="list-style-type: none"><li>• Take out the filter drawer sponge.</li></ul>
------------------------------------------------------------------------------------	--------------------------------------------------------------------------------------

<ul style="list-style-type: none"><li>• Clean the fluff and lint over the filter sponge washing it with your hands. Remove the moisture squeezing the sponge with your hands after washing it.</li><li>• Clean the fluff, lint and cotton pellets with your hands or with a soft cloth.</li></ul>	
---------------------------------------------------------------------------------------------------------------------------------------------------------------------------------------------------------------------------------------------------------------------------------------------------	--



- If you observe a layer over the filter which can block the filter, remove the layer washing with a water and then cleaning it. Dry the filter cloth properly before replacing the filter drawer.

- Replace the filter drawer and tighten the cap turning the filter drawer lock turning it in the arrow direction.

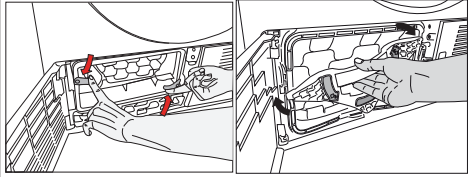

**i NOTE**

- There may be no cloth in the filter cassette of your drying machine, depending on its model.

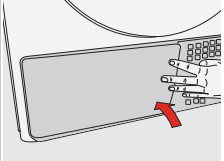

- Close the kick plate cover.



- Place the sponge back into its place.

**! WARNING!**

- Drying without the filter drawer sponge in place will damage the machine!

**i NOTE**

- Please place the sponge carefully inside the frame of the filter cassette shown by arrows in order to avoid squeezing when filter drawer closed”.::

**i NOTE**

- A dirty lint filter and filter drawer will cause longer drying periods and higher energy consumption.

### 6.5 Cleaning the evaporator

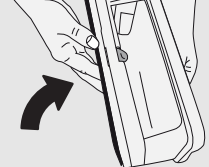

- Close the filter drawer as to lock the red button.

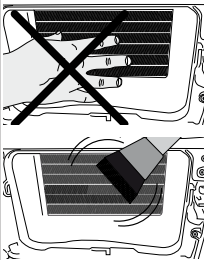

- Clean the lint accumulated on the fins of the evaporator located behind the filter drawer with a vacuum cleaner.

**! WARNING!**

- You can also clean by hand provided that you wear protective gloves. Do not attempt to clean with bare hands. Evaporator fins can harm your hand.

## 7 Troubleshooting

### Drying operation takes too long.

Fibre filter pores might be clogged. >>> Wash the filter with warm water.

Filter drawer might be clogged. >>> Clean the sponge and filter cloth (if any) in the filter drawer. (for the products with a heat pump)  
The condenser might be blocked. >>> Wash the condenser.(for the products with a condenser )

The ventilation grills in front of the machine may be closed. >>> Remove any objects in front of the ventilation grills that blocks air. Ventilation may be inadequate because the area the machine is installed in is too small. >>> Open the door or windows to prevent the room temperature from rising very high.

A lime layer may have accumulated on the humidity or temperature sensors. >>> Clean the humidity or temperature sensors.

Excessive amount of laundry might be loaded. >>> Do not load the drying machine excessively.

Laundry might not have been wrung adequately. >>> Perform a higher speed wringing on the washing machine.

### Clothes come out damp after drying.

A program not suitable for the laundry type may have been used.>>> Check the maintenance labels on the clothes and select a program suitable for the clothes' type or use time programs as extra.

Fibre filter pores might be clogged. >>> Wash the filter with warm water.

The condenser might be blocked. >>> Wash the condenser. (for the products with a condenser)

Filter drawer might be clogged. >>> Clean the sponge and filter cloth (if any) in the filter drawer.(For the products with a heat pump)  
Excessive amount of laundry might be loaded. >>> Do not load the drying machine excessively.

Laundry might not have been wrung adequately. >>> Perform a higher speed wringing on the washing machine.

### Drying machine does not turn on or program cannot be started.

Drying machine does not run after it is configured.

Power plug might be unplugged. >>> Make sure the power cord is plugged in.

Loading door might be open. >>> Ensure that the loading door is properly closed.

A program might not be set or Start/Stand-by button might not be pressed. >>> Check that the program is set and it is not in Stand-by position.

Child lock may be activated. >>> Turn off the child lock.

### Program terminated prematurely for no reason.

Loading door might not be closed completely. >>> Ensure that the loading door is properly closed.

There might be a power outage. >>> Press the Start/Stand-by button to start the program.

Water tank may be full. >>> Empty the water tank.

### Clothes have shrunk, hardened or spoiled.

A program not suitable with the laundry type might have been used. >>> Check the maintenance labels on the clothes and select a program suitable for the clothes.

The lighting inside the drying machine does not turn on. (For models with a lamp)

Drying machine might not be turned on with the On/Off button or program might not be selected for machines without an On/Off button. >>> Make sure that the drying machine is turned on.

Lamp might be malfunctioning. >>> Contact Authorized Service to replace the lamp.

Filter cleaning warning symbol/LED is on/flashing.

Fibre filter might not be cleaned. >>> Clean the filter.  
The filter slot might be clogged with lints. >>> Clean the filter slot.  
A layer of fluff might have accumulated clogging up the lint filter pores. >>> Wash the filter with warm water.  
The condenser might be blocked. >>> Wash the condenser.

### Water drips from the loading door.

Fibres might have gathered on the inner sides of the loading door and the loading door gasket. >>> Clean the inner surfaces of the loading door and the loading door gasket surfaces.

### Loading door opens by itself.

Loading door might not be closed completely. >>> Push the loading door until the closing sound is heard.

### Water tank warning symbol / led is on/flashing.

Water tank may be full. >>> Empty the water tank.  
Water discharge hose might have collapsed. >>> If the product is connected directly to the water drain check the water discharge hose.

### Steam symbol is flashing.(For the products with a steam function)

Steam tank may be empty => Fill the steam tank with distilled or condensed water.

### Steam programs do not start (For the products with a steam function)

Steam tank may be empty, steam tank warning icon may light up on the screen => Fill the steam tank until the steam icon goes off.

Wrinkles are not removed with wrinkle removing program. (For the products with a steam function)

Excess amount of laundry may have been placed => Place specified amount of laundry.  
Steam application time may be selected in low level => Choose a program with high amount of steam.  
After completion of the program, the laundry may have stayed in the machine for a long time => Take the laundry out as soon as the program finishes, and hang it out.

Laundry odour not lessened with the odour removal program.(For the products with an odour removal program)

Excess amount of laundry may have been placed => Place specified amount of laundry.  
Steam application time may be selected in low level => Choose a program with high amount of steam.



## WARNING!

- If the problem persists after following the instructions in this section, contact your vendor or an Authorized Service. Never try to repair your product yourself.



## NOTE

- In an event that you encounter an issue on any part on your appliance, you can ask for a replacement by contacting the authorized service with the appliance model number.
- Operating the appliance with non-authentic parts may lead the appliance to malfunction.
- Manufacturer and distributor are not liable for malfunctions resulting from using non-authentic parts.

## 8 Electrical Connection

Make sure that you have an earthed power outlet socket rated at 13 amps (minimum).

### 8.1 Attention!

When installed, the socket must be reachable after installation, or a separate switch (which can disconnect the two poles) must be used in the installation. Check for suitability. For a permanent connection, a master switch with at least 3mm contact clearance and minimum 13 A rating must be used.

### 8.2 Electrical requirements

Before you insert the plug into the wall socket make sure that the voltage and the frequency shown in the rating label corresponds to your electricity supply.

We recommend that this appliance be connected to the mains supply via a suitable switched and fused socket in a readily accessible position. Should the mains lead of the appliance become damaged or need replacing at any time, it must be replaced by a special purpose made mains lead which can only be obtained from a Authorised Service Agent.



### WARNING!

This appliance must be earthed. If the fitted moulded plug is not suitable for your socket, then the plug should be cut off and an appropriate plug fitted. The moulded plug on this appliance incorporates a 13A fuse. Should the fuse need to be replaced an ASTA approved BS1362 fuse of the same rating must be used. Do not forget to refit the fuse cover. In the event of losing the fuse cover, the plug must not be used until a replacement fuse cover has been fitted. Colour of the replacement fuse cover must be the same colour as that visible on the pin face of the plug. Fuse covers are available from any good electrical store. In order to avoid hazards, damaged supply cord should be replaced by the manufacturer, its service agent or similarly qualified people. Built-under installation  
This appliance can be installed under a worktop.



### WARNING!

Do not operate without the top cover fitted.  
Risk of injury.



### IMPORTANT!

### 8.3 Fitting a different plug

As the colours of the wires in the mains lead of this appliance may not correspond with the coloured markings identifying the terminals on your plug, proceed as follows:

- 1 Connect the green - yellow or green (earth) wire to the terminal in the plug marked 'E' or with the symbol or coloured green and yellow or green.
  - 2 Connect the blue (neutral) wire to the terminal in the plug marked 'N' or coloured black.
  - 3 Connect the brown (live) wire to the terminal in the plug marked 'L' or coloured red.
- With the alternative plugs a 13A fuse must be fitted either in the plug or adaptor or in the main fuse box. If in doubt contact a qualified electrician.

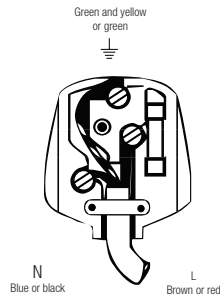

### 8.4 Washer/dryer combination

Do not stack washing machine on top of the tumble dryer. This would damage both appliances and guarantees would become void. It is also unsafe to stack an appliance on top of another without using a suitable and approved stacking kit obtained from the manufacturer of the appliances.

- A special stacking kit is required as an optional extra please contact customer service.

## PRODUCT FICHE

### Complying Commission Delegated Regulation (EU) No 392/2012

Supplier name or trademark		BEKO
Model name		DTBP8001W / DTBP8001A DTGP 8000 W
Rated capacity (kg)		8
Type of Tumble Dryer	Air Vented	-
	Condenser	•
Energy efficiency class <sup>(1)</sup>		A+
Annual Energy Consumption (kWh) <sup>(2)</sup>		297
Type of Control	Automatic	•
	Non-automatic	-
Energy consumption of the standard cotton programme at full load (kWh)		2,47
Energy consumption of the standard cotton programme at partial load (kWh)		1,35
Power consumption of the off-mode for the standart cotton programme at full load, P <sub>O</sub> (W)		0,5
Power consumption of the left-on mode for the standart cotton programme at full load, P <sub>L</sub> (W)		1,0
The duration of the left on mode (min)		30
Standard cotton programme <sup>(3)</sup>		
Programme time of the standard cotton programme at full load, T <sub>dry</sub> (min)		197
Programme time of the standard cotton programme at partial load, T <sub>dry1/2</sub> (min)		115
Weighted programme time of the standard cotton programme at full and partial load (T <sub>w</sub> )		150
Condensation efficiency class <sup>(4)</sup>		B
Average condensation efficiency of the standard cotton programme at full load, C <sub>dry</sub>		81%
Average condensation efficiency of the standard cotton programme at partial load, C <sub>dry1/2</sub>		81%
Weighted condensation efficiency of the standard cotton programme at full load and partial load, C <sub>w</sub>		81%
Sound power level for the standard cotton programme at full load <sup>(5)</sup>		65
Built-in		-

• : Yes    - : No

(1) Scale from A+++ (most efficient) to D (least efficient)

(2) Energy consumption based on 160 drying cycles of the standard cotton programme at full and partial load, and the consumption of the low-power modes. Actual energy consumption per cycle will depend on how the appliance is used.

(3) "Cotton cupboard dry programme" used at full and partial load is the standard drying programme to which the information in the label and the fiche relates, that this programme is suitable for drying normal wet cotton laundry and that it is the most efficient programme in terms of energy consumption for cotton

(4) Scale from G (test efficient) to A (most efficient)

(5) Weighted average value — L<sub>WA</sub> expressed in dB(A) re 1 pW

## BEKO UK AND IRELAND STANDARD MANUFACTURER GUARANTEE TERMS AND CONDITIONS

Your new Beko product is guaranteed against faulty materials, defective components or manufacturing defects.

**The standard guarantee starts from the date of original purchase of the product, and lasts for a period of twelve (12) months unless Beko plc (the “Manufacturer”) agrees to extend the guarantee for the product in writing.**

**If you have purchased an American style Fridge freezer, the standard guarantee starts from the date of original purchase of the product, and lasts for a period of twenty four (24) months unless Beko plc (the “Manufacturer”) agrees to extend the guarantee for the product in writing.**

If you have any questions about the guarantee on your product (including how long it is valid), please contact your retailer or our contact centre on **0333 207 9710** (UK and Northern Ireland) or **01 862 3411** (Republic of Ireland)

This guarantee does not in any way diminish or affect your statutory rights in connection with the product. This guarantee is in addition to your statutory rights as a consumer. If you have any questions about these rights, please contact the retailer from which you purchased the product. In certain circumstances, it is possible that your statutory rights may offer additional or higher levels of protection than those offered under the terms of this guarantee.

### What is covered by this guarantee?

- Repairs to the product required as a result of faulty materials, defective components or manufacturing defects.
- Functional replacement parts to repair a product.
- The costs of a Beko Approved Engineer to carry out the repair.

### What is not covered?

- Transit and delivery damage.
- Cabinet or appearance parts, including but not limited to control knobs, flaps and handles.
- Accessories and/or consumable items including but not limited to ice trays, scrapers, cutlery baskets, filters and light bulbs.
- Repairs necessary as a direct or indirect result of:
  - Accidental damage, misuse or abuse of a product.
  - An attempted repair of a product by anyone other than a Beko Approved Engineer (the “Engineer”).
  - Installation or use of a product where such installation or use fails to meet the requirements contained in this guarantee or the User Instructions Booklet.
- Repairs to a product operated at any time on commercial or non-residential household premises (unless we have previously agreed to the installation environment).

This guarantee is limited to the cost of repairing the product. To the extent permitted by law, the Manufacturer does not accept and will not be held liable for any financial loss incurred in connection with the failure of any product to operate in accordance with the expected standards. Such financial loss includes but is not limited to loss arising from:

- Time taken off work.
- Damaged food, clothing or other items.
- Meals taken at restaurants or from takeaways.
- General compensation for inconvenience.

### Important Notes

1. Your product is designed and built for domestic household use only.
2. The guarantee will automatically be void if the product is installed or is used in commercial or non-residential domestic household premises, unless we have previously agreed to the installation environment.
3. The product must be correctly installed, located and operated in accordance with the instructions contained in the User Instructions Booklet provided with your product.
4. Professional installation by a qualified Electrical Domestic Appliance Installer is recommended for all Washing Machines, Dishwashers and Electric Cookers (as incorrect installation may result in you having to pay for the cost of repairing the product).
5. Gas Cookers must be professionally installed by a Gas Safe (or Gas Networks Ireland for Republic of Ireland) registered gas installer.
6. This guarantee is given in respect of products purchased and used within the United Kingdom and the Republic of Ireland.
7. This guarantee is effective from the initial date of purchase of a new product from an authorised retailer and will be void if the product is resold.
8. This guarantee does not apply to graded sales (where the product is purchased as a “second”).

9. Possession of a copy of these terms and conditions does not necessarily mean that a product has the benefit of this guarantee. If you have any questions, please call our Call Centre on the number set out above.
10. The Manufacturer reserves the right to terminate the guarantee if its staff or representatives are subjected to physical or verbal abuse in the course of carrying out their duties.
11. Optional extras, where available (i.e. extendable feet) are supplied on a chargeable basis only.

#### **Does Beko offer replacements?**

This is a repair-only guarantee. On occasion, the Manufacturer may at its sole discretion, replace your product with a new product instead of carrying out a repair. Where a replacement is offered, this would normally be an identical model but when this is not possible, a model of similar specification will be provided. The Manufacturer will cover the costs and arrange for the delivery of the new product and for the return of the old product. Any costs related to disconnecting the faulty product and installing the replacement product will not be borne by the Manufacturer unless previously agreed to in writing. The original guarantee will continue to apply to the replacement product; the new product will not come with a new guarantee.

#### **When will the repair take place?**

Our Engineers work Monday to Friday 9.00am to 5.00pm. Appointments outside these hours may be possible at the sole discretion of the Manufacturer but cannot be guaranteed. Whilst our Engineers will endeavour to minimize inconvenience and to meet requests for specific timed appointments, this cannot be guaranteed. We will not be liable for delays or if it is unable to carry out a repair because a convenient appointment cannot be arranged.

#### **Will there be any charge for the repairs?**

It is your responsibility to provide evidence to the Engineer that your product is covered by this guarantee with a proof of purchase. The Manufacturer reserves the right to charge for the reasonable cost of any service call if:

- You cannot provide evidence that your product is covered by this guarantee.
- Where a service call has been made and the engineer finds that there is no fault with your product.
- That your product has not been installed or operated in accordance with the User Instructions Booklet.
- That the fault was caused by something other than faulty materials, defective components or manufacturing defects.
- For missed appointments.

Payment of these costs are due immediately upon the Engineer providing you with an invoice. The Manufacturer reserves the right to terminate the guarantee if you fail to pay the costs for the service call in a timely manner.

If you are a resident of the United Kingdom, this guarantee will be governed by English law and subject to the English Courts, save where you live in another part of the United Kingdom, in which case the law and courts of that location will apply.

If you are resident in the Republic of Ireland, this guarantee will be governed by Irish law and the Irish courts will have jurisdiction.

This guarantee is provided by Beko plc. Beko House, 1 Greenhill Crescent, Watford, Hertfordshire. WD18 8QU.

Beko plc is registered in England and Wales with company registration number 02415578.

#### **BEKO UK AND IRELAND BUILT-IN APPLIANCES GUARANTEE TERMS AND CONDITIONS**

If you have purchased a built-in or integrated appliance, and registered it within 90 days of purchase by completing the online registration form, then the standard 12 month guarantee will be extended to 24 months, under the same terms and conditions as detailed in our Standard Guarantee Terms and Conditions.

## BEKO UK AND IRELAND PROSMART INVERTER MOTOR GUARANTEE TERMS AND CONDITIONS

**This 10 year guarantee relates to Beko products that feature the ProSmart Inverter Motor.**

The ProSmart Motor guarantee terms and conditions are in addition to our Standard guarantee terms and conditions detailed in the previous section.

**In order to activate the 10 year guarantee you MUST register the appliance within 90 days of the original purchase date. You can register by first visiting [Beko.co.uk/register](http://Beko.co.uk/register) and by following the online instructions.**

Beko Free standing appliances come with a 12 month parts and labour guarantee as standard,

Beko Built-in appliances come with a 12 month parts and labour guarantee as standard. This is extended to 24 months, free of charge, upon registration of the appliance. When you register your appliance for additional guarantee, you will automatically activate the ProSmart Motor 10 year guarantee. You do not need to register twice. ([beko.co.uk/guarantee-terms](http://beko.co.uk/guarantee-terms)).

To make a claim against your Beko ProSmart Inverter Motor Guarantee (the "Guarantee"), all customer and product details must be registered with Beko plc using the procedure outlined below.

1. This extra 9 years (for free standing appliances) or 8 years (for built-in or integrated appliances) guarantee is only effective after the expiration of the standard manufacturer's guarantee.
2. It is only valid for the ProSmart Inverter motors of selected washing machines, washer-dryers, tumble dryers and dishwashers. It does not cover any labour charge or any other components of the product. In addition, it is only valid for one replacement of the ProSmart motor during the extra 9-year (for free standing appliances) or 8 year (for built-in appliances) guarantee period.
3. To activate your guarantee, you MUST register your appliance within 90 days of the original purchase date, by visiting [beko.co.uk/register](http://beko.co.uk/register).
4. Customers will receive a unique reference code as proof of guarantee validation by email or post, which must be quoted at the time of a claim being made.
5. Any repair/replacement of the ProSmart Inverter motor must only be carried out by an authorised Beko Service Agent (the "Service Agent").
6. Labour for the repair/replacement of the ProSmart Inverter motor is not included in this guarantee and is chargeable directly by the Service Agent.
7. Any additional components fitted to the product at any time will not be covered by this guarantee and will be chargeable directly by the Service Agent.
8. The guarantee is not transferable and cannot be exchanged for cash.
9. There are no alternative or additional offers to this Guarantee.
10. The guarantee is exclusive of the manufacturer's standard guarantee
11. The Terms and Conditions shown above are in addition to the standard terms and conditions of your product guarantee. Please read and refer to such Terms and Conditions when making any claim.
12. We may use the information you provide for marketing purposes and to analyse your purchasing preferences. We may keep your information for a reasonable period for these purposes in accordance with the applicable Data Protection Laws and General Data Protection Regulations (GDPR). You can opt into this service during the registration process. Further details are available at <http://www.beko.co.uk/cookie-and-privacy>.
13. These Terms and Conditions are governed by the laws of England and Wales; manufacturer: Beko plc, Beko House, 1 Greenhill Crescent, Watford WD18 8QU. Company Registration Number: 02415578.

## HOW TO OBTAIN SERVICE FOR YOUR APPLIANCE

Please keep your purchase receipt or other proof of purchase details in a safe place; you will need to have this documentation available should the product require attention under guarantee.

Please take a few moments to complete the details below, as you will need this information when you call us, or to use our online services. When you call us you may be required to input your serial number into your telephone keypad. For help please visit [beko.co.uk/support/model-finder](http://beko.co.uk/support/model-finder)

- The product model number is printed on the Operating Instruction Booklet / User guide
- The product model and serial number is printed on the Rating Label affixed to the appliance.
- The Retailer (Purchased from) and Date of purchase will be printed on your purchase receipt or other proof of purchase paperwork

Recording of these details alone will not count as proof of purchase. A valid proof of purchase is required for requesting service under guarantee.

Model number	Serial number	Purchased from	Date of purchase

### For service under guarantee or for product advice please call our Contact centre

Before requesting service please check the troubleshooting guide in the Operating Instructions booklet, as a charge may be levied where no fault is found, and even though your product may still be under guarantee.

After arranging service the area around the product must be easily accessible to the Engineer, without the need for cabinets or furniture to be removed or moved.

It is your responsibility to ensure our Engineers have a clean and safe environment to carry out any repairs.

Please have your Model number and Serial number available when you call us, as you may be required to input your serial number into your telephone keypad during your call.

**UK Mainland & Northern Ireland:**

# 0333 207 9710

*Landline or mobile calls to 0333 numbers cost no more than calls to geographic numbers 01 or 02, and are charged at the basic rate. Calls from landlines and mobiles are included in free call packages but please check with your telephone service provider for exact call charges.*

**Republic of Ireland:**

# 01 862 3411

### Service once the manufacturers guarantee has expired

*If you have purchased an extended guarantee please refer to the instructions contained within the extended guarantee agreement document, otherwise please call us using the appropriate number above, where service can be obtained at a charge.*

Should you experience any difficulty in obtaining service please call us on **0333 207 9710** or **01 862 3411**

### Contact us though our website

Send us a secure message through our online contact us form. Please visit our website, click Contact Us and choose a product support topic from the list of options. Complete the required details and click send message.

### Product registrations

For UK registrations please visit [beko.co.uk/register](http://beko.co.uk/register) and for the Republic of Ireland visit [beko.ie/register](http://beko.ie/register).





