

BEKO

BEKO

*installation & operating
instructions and cooking guidance*

Double oven
electric cooker with
ceramic hob

Model
DVC665

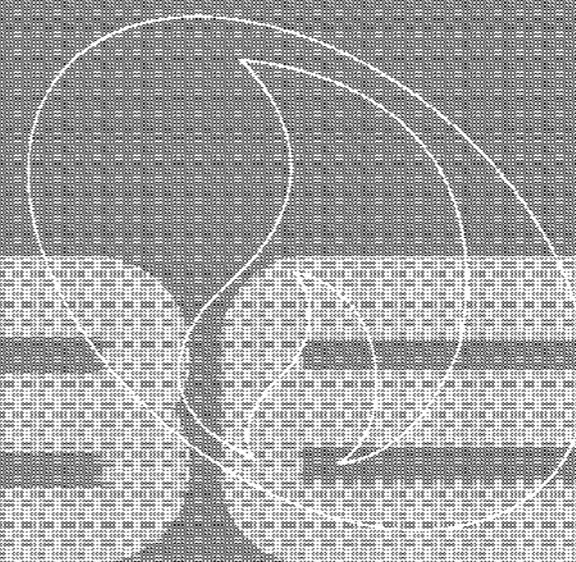
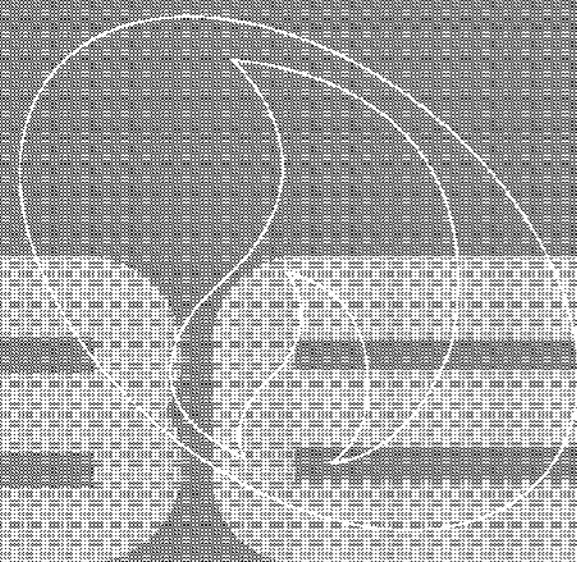

get the **best** from your new cooker

Beko plc
Beko House
Caxton Way
Watford
Herts WD1 8UF
Tel: 01923 818121

Printed in Turkey

Part no.285.9204.39

Dear customer

Congratulations on your choice of a Beko quality cooker which has been designed to give you lasting service.

The cooker must be installed by a qualified electrician in accordance with current regulations and used in a well ventilated space.

Please read these instructions thoroughly before installing or using - and keep for handy reference. Make sure you understand the controls prior to using your appliance. This cooker must only be used for its intended purpose, ie the cooking of food in the home. Failure to observe these instructions may invalidate your right to free service during the guarantee period.

If you have any questions, or if you are not sure about any information contained in this booklet please contact us - details are on the back cover.

Your Customer Service

safety symbols

The use of any electrical appliance and cookers in particular (which use high temperatures) require the following of basic common sense safety rules.

There is a danger of injury to the person and of damage to the cooker, the kitchen and your home.

These are itemised in the first section 'Safety in the home'. Where accidents are most common, we repeat these warnings in the main text using the following symbols:



Where you, other people, toddlers and children are at risk



Where there is a danger of damage to the cooker, utensils, surrounding areas and property

Please note them for your own safety.



Introduction

Welcome/Safety symbols	2
Safety in the home	4

Installation

Know your cooker/specification	6
Electrical connection and location	7
Installation	8

For the very first time

Preparation and burning off	8
-----------------------------	---

Operating

Operating the hob	9
Saucepan types/deep fat frying	10
Operating the grill/top oven	11
Operating the fan oven	13
Operating the digital programmable timer	14-15

Cooker care

Care & cleaning	19
Trouble shooting	20
Future transportation	21
Replacing the oven light	21
Guarantee & service	22

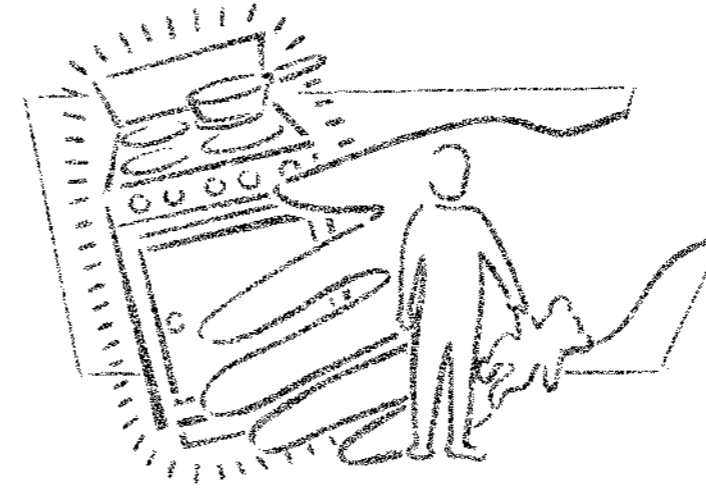

! Look after yourself, family and friends

- Ensure that children are kept away whilst the cooker is in use and until it has cooled as parts become very hot. Don't leave them unsupervised.
- During use surfaces get hot. Don't touch hot surfaces during use.
- Close supervision while cooking is essential at all times.
- Special care should be taken when cooking oily and fatty food as overheating of such food can cause them to catch fire.
- Always use good quality oven gloves when removing hot utensils and the grill pan from the oven.
- Ensure handles of pans can not accidentally be caught or knocked and do not get heated by adjacent heating zones.
- Check all controls on the appliance are switched off after use.
- Take care when opening the door. Let steam and hot air escape before removing the food.
- Select the correct shelf position before turning the oven or grill on - don't move oven shelves when hot.
- Don't use water to extinguish oil or fat fires.
- Don't heat up unopened food containers as pressure can build up causing the container to burst.
- Don't use round-bottomed traditional woks. Use flat-bottomed types.
- Don't store items above the cooker that children may try to reach.

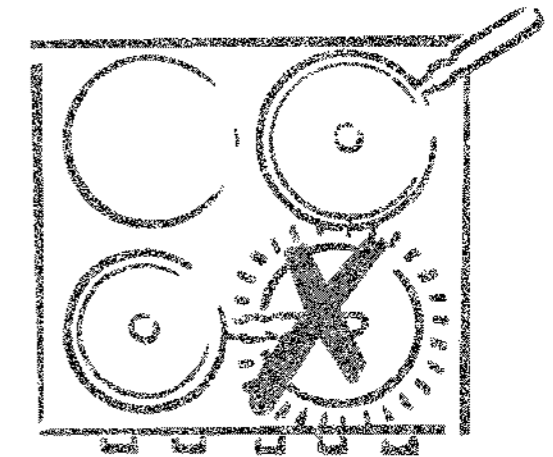

Look after your cooker and home

- Clean your cooker regularly, ideally after each use. Always turn off the mains electricity supply and allow the appliance to cool first.
- Spillage should be dealt with as soon as it occurs, taking due care as the hob surface may be hot. Any spillage left on the surface after cooking should be cleaned off before the hob is switched on again to prevent baking on.
- Don't use biological washing powder or bleach products, harsh abrasives or chemical cleaners for cleaning the oven inner panels.
- Don't allow anyone to sit or stand on the cooker or door.
- Don't move the cooker by pulling by the door and/or handle.
- Don't use large preserving pans or fish kettles across the hob as this will damage the ceramic hob.
- Ensure that no flammable materials are adjacent to the cooker as the sides become hot during use.
- Don't store flammable materials, aerosols etc in adjacent cabinets.
- Don't place flammable or plastic items on or near the hob, and never place wet cloths etc. on the hob to dry.
- Keep all ventilation slots clear of obstructions.
- Don't leave a burner on for long periods when not covered by a pan.
- Don't cover shelves with metal foil as the air circulation in the oven will be disrupted.
- Don't place dishes, pans and/or trays directly on the oven compartment base.
- Don't line the grill pan with aluminium foil. As this could result in an increased risk of fire or damage to your cooker.
- Don't use the cooker with glass panels removed.

Don't use the cooker for

- Hanging towels and dish cloths etc on the handles.
- Warming plates under the grill.
- Heating the kitchen.
- Drying.

Food hygiene

- Ensure meat and poultry is thoroughly defrosted before cooking.
- Check food is thoroughly cooked and is piping hot.
- **Always refer servicing to a qualified appliance service engineer.**

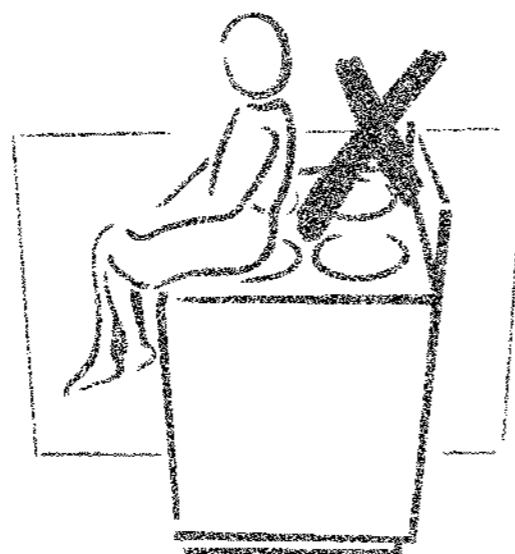

Your Beko product is guaranteed against the cost of breakdown repairs for twelve months from the date of the original purchase.

What is covered?

- All repairs necessary as a result of faulty materials, defective components or manufacturing defect.
- The cost of all functional replacement parts.
- The labour costs of a Beko approved repairer to carry out the repair.

What is not covered?

- Transit or delivery damage
 - Accidental damage
 - Misuse, or abuse.
 - Cabinet or appearance parts, including knobs and flaps
 - Accessory items, including ice trays, scrapers, cutlery baskets,
 - Repairs required as a result of unauthorised repairs or inexperienced installation that fails to meet the requirements contained in the user instruction book.
- Repairs to products used on commercial or non-residential household premises.

Important notes.

- The product is guaranteed for domestic household use only.
- The guarantee will be void if the product is installed or used in commercial or non-residential household premises.
- The product must be correctly installed, located and operated in accordance with the instructions contained in the User Instructions Booklet provided.
- Professional Installation by a qualified plumber/electrical appliance installer is recommended for all Washing & Dishwashing Machines and Electric Cookers
- Gas Cookers must only be installed by a CORGI (or BORD GAIS) registered Gas Installer.
- The guarantee is given only within the boundaries of the United Kingdom.
- The guarantee is not transferable if the product is resold.
- Beko plc disclaims any liability for incidental or consequential damages.
- The guarantee does not in anyway diminish your statutory or legal rights.

HOW TO OBTAIN SERVICE UNDER THE MANUFACTURERS GUARANTEE

Please keep your purchase receipt or other proof of purchase in a safe place; you will need to have it should the product require attention in the guarantee period

You should also complete the details below; it will help us assist you quicker when requesting service. (The model number is printed on the Instruction Booklet)

Model Number: _____ Purchased From: _____ Date of purchase: _____

For service under guarantee simply telephone the appropriate number below

LOCATION	TELEPHONE
UK Mainland & Northern Ireland	
Fridges & Freezers	0870 241 0638
Electric Cookers	0870 241 1320
Gas & Dual Fuel Cookers	0870 241 1321
Washing Machines & Dishwashers	0870 241 0357
Republic of Ireland	
All Refrigeration, Cooking, Washing & Dishwashing Machines	01 862 3411

Before requesting service please check the trouble-shooting guide in the Operating Instructions as a charge may be levied where no fault is found even though your product may still be under guarantee.

Service once the manufacturers guarantee has expired.

If you have purchased an extended guarantee please refer to the instructions contained within the extended guarantee agreement document. Otherwise please call the above numbers where service can be obtained at a charge.

Should you experience any difficulty in obtaining service please call the

Beko Customer Help-Line on 0870 774 1050

Beko House, Caxton Way, Watford, Herts, WD18 8UG, Tel: 0870 774 1050

future transportation

Keep the original carton and other packaging material in a safe place. Transport the cooker in its original carton. Follow the instructions that are printed on the carton.

To prevent the accessories inside the oven from damaging the oven door, tape a strip of cardboard onto the inside of the oven door that lines up with the position of the trays. Tape the oven door to the side walls.

If you do not have the original carton

Take the necessary precautions in order to prevent the exterior panels, and the glass surfaces of the oven from being damaged.

Pack the oven in bubble wrap or thick cardboard and tape it securely in order to prevent damage during transportation.

The oven must be transported upright. Do not place other items on the top of the cooker.

replacing the oven lamp



Ensure that the appliance is switched off at the mains supply, before replacing the lamp to avoid the possibility of electric shock.

- 1 Switch off at the mains.
- 2 Remove the protective glass cover of the lamp inside your oven by turning it anti-clockwise.
- 3 Remove the bulb by turning it anti-clockwise.
- 4 After installing the correct replacement bulb, reinstall the protective glass of the lamp.

Replacement light bulb can easily be obtained from a good local electrical or DIY store.

know your cooker

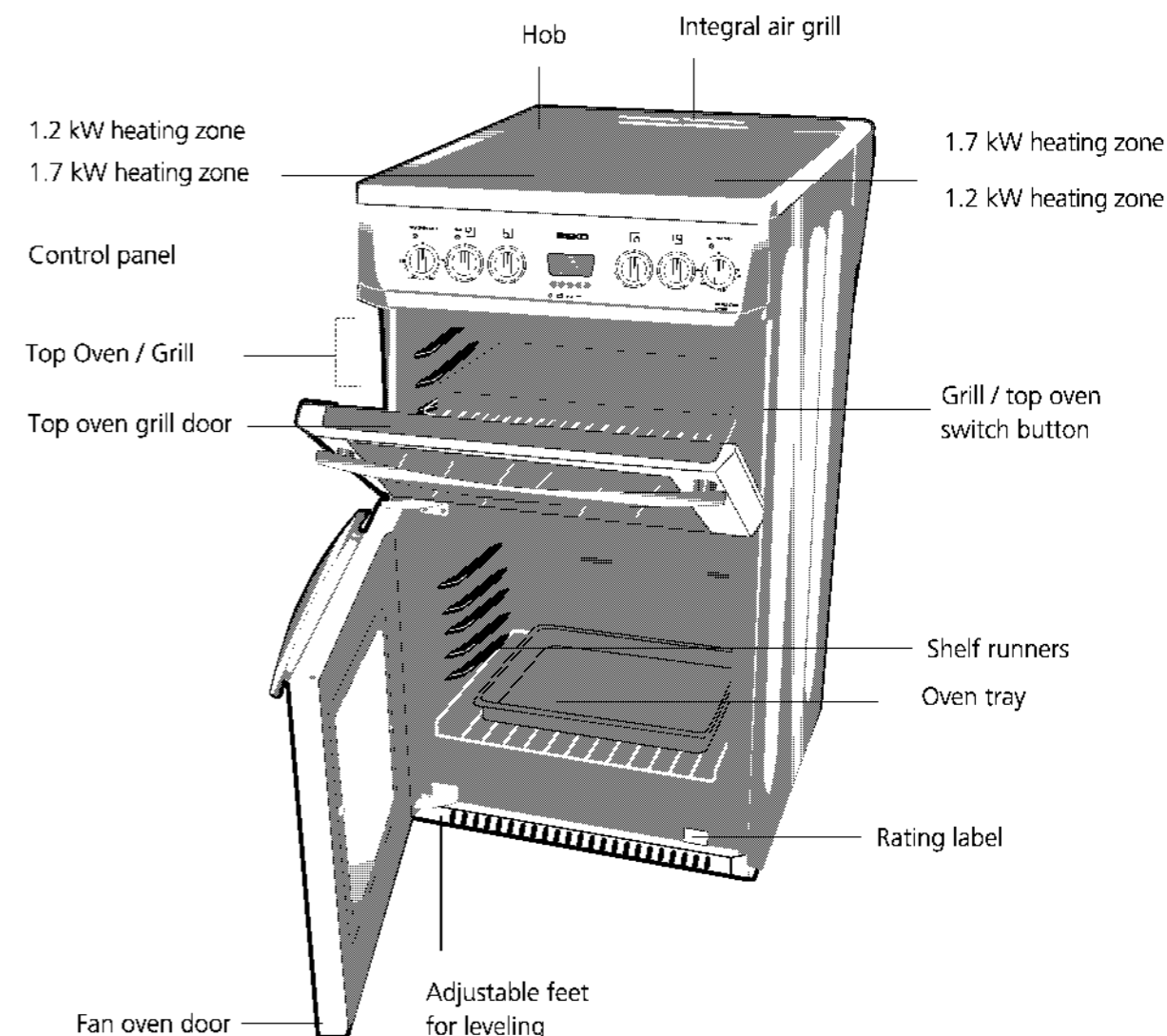

specification

Supply voltage	230V AC
Supply frequency	50 Hz
Maximum wattage	9900 W
Grill wattage	2200 W
Top oven wattage	1100 W
Fan oven wattage	1800 W
Hotplate wattage - Front left	1700 W
Hotplate wattage - Rear left	1200 W
Hotplate wattage - Front right	1200 W
Hotplate wattage - Rear right	1700 W

Unpacked external dimensions H:	900mm
W:	600mm
D:	600mm
Packed external dimensions H:	1000 mm
W:	680 mm
D:	700 mm
Net weight	70 kg
Gross weight	77 kg

Accuracy

Note that times and temperatures in this book are for guidance only.

Because we continually strive to improve our products, we may change our specifications and designs without prior notice.

electrical connection

- Do not connect the cooker to the electricity supply until all packing and transit protectors have been removed.

1 Before your appliance is connected to the mains electricity supply, check to ensure that the voltage and frequency shown on the rating label corresponds with your power supply. The label is located on the plinth below the oven door.

2 This product must only be installed by a qualified electrician eg local electricity company or NICEIC registered contractor to a suitable double-pole control unit with a minimum contact clearance of 3mm in all poles and with a minimum rating of 32A which should be fitted adjacent to (but not above) the cooker in accordance with IEE regulations. Failure to observe this instruction may result in operational problems and invalidation of the product warranty.

3 Access to the mains terminal is gained by removing the small rear cover. The cable must have conductors of sufficiently high cross sectional area to prevent overheating and deterioration.

Recommended cross-section area is six square millimetres (6.00 mm²). The mains cable must conform to BS6004.

! This appliance must be earthed.

4 The mains cable must pass through the cable clamp.

5 The mains cable should be routed away from the appliance and in particular ventilation slots, the vent outlet and should not be obstructed when pushed in to position between the appliance and the wall and/or cabinets.

- The appliance conforms to BS 800: 1988 and EEC directive 87/308 regarding suppression of radio and television interference.
- Type with regard to protection against overheating of surrounding surfaces=X.

Models with removeable inner glass panels

When you wish to clean the interior glass of the oven door, use a screwdriver to remove the top and bottom washers that secures the interior glass to the door, remove the glass with care.

Clean as above, but do not use house hold detergents, bleach, scouring pads or rust removers. After drying, position the gasket back into its place. Reinstall the glass panels carefully preventing sudden shocks.



Over time...

- Slight discolouration of liners and other surfaces may occur in time. This does not affect the functioning of the appliance.
- Discolourations and marks that occur on the ceramic hob are normal and not a fault.

location

• Excess steam from the oven is expelled at the rear of the appliance therefore the wall behind the cooker needs to be protected against grease and moisture.

• The cooker is designed to fit between kitchen cabinets spaced over 600 mm apart. The space either side of the cooker need only be sufficient to allow withdrawal of the cooker for servicing. It can be used with cabinets on one side or both sides as well as in a corner setting. It can also be used free-standing.

• Adjacent side walls above the appliance must not be nearer to the cooker than 150mm and should be of heat resistant material. Leave at least 750 mm clearance above the hob.

• The cooker should not be placed on a raised base.

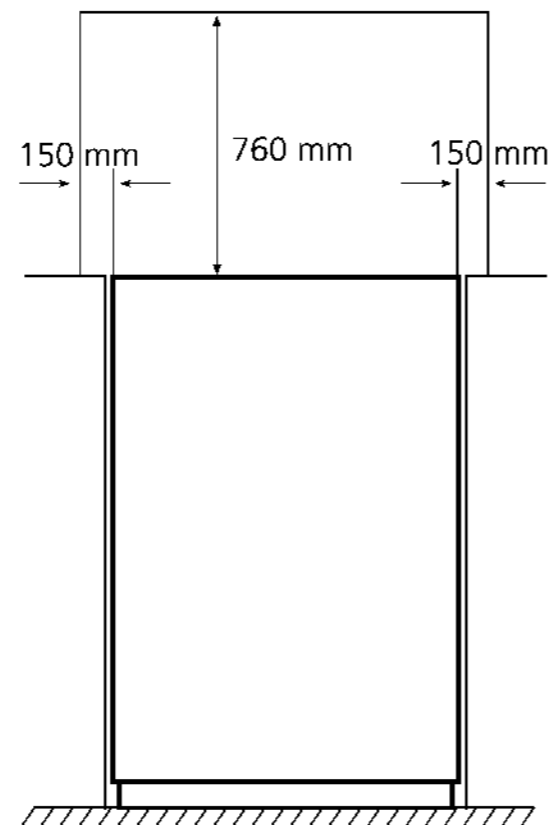

trouble shooting

If the cooker does not work

If the appliance does not operate check whether:

- The power supply is on.
- The fuse has blown/circuit breaker has tripped/main distribution switch has been turned off.
- The control has been set correctly.
- Oven programmer has been reset.

If the appliance is still not operating after the above checks, please refer to the section on how to obtain service.

Please ensure that the above checks have been made as a charge will be made if no fault is found.

Performance characteristics when in use

- When using your appliance for the first few times, an odour and/or smoke may be emitted which is normal** - see page 8.
- It is normal for the metal parts to produce noise when in use, this is due to expansion and contraction.
- When in use, steam may be produced which is normal and not a fault of the cooker.
- At the end of a cooking session, it is normal to have a momentary puff of steam when the oven door is opened. This should disperse in a few seconds.
- If, whilst cooking, steam produced comes in to contact with cool surface's on the outside of the appliance, it will condense and produce water droplets. This is quite normal and is not a fault.

! Turn OFF at the mains before cleaning.

- Before switching on again ensure that all controls are in the OFF position.
- **Make sure that the oven, grill and hobs are sufficiently cool before you start cleaning.**
- Never mix different cleaning products as different active ingredients may react with unforeseen results.

Exterior

Use a damp cloth to clean the outside. Never use any sharp instruments, abrasive household cleaner, or detergents for cleaning. For hard stains use suitable washing liquid.

Ceramic hob

Clean daily to avoid soilage being burnt on.

- 1 Be sure to use a cleaning agent that does not scratch the ceramic glass surface. We recommend Hob Brite Ceramic Hob Cleaner which is available from your local supermarket. Follow the manufacturer's instructions.
 - 2 Always rinse off fully with a clean cloth wrung out in clean water (as residue could damage the ceramic glass surface next time the hob is used).
 - 3 Wipe the surface dry with a soft cloth.
- **Do not use steel wool, abrasive powders, detergents or bleach-based cleaning agents as these will damage the surface.**
 - You can use a ceramic hob scraper (available through Hob Brite and good local stores) to remove spilled food remains and stubborn marks from the surface.
 - **Sugar-based food such as custard and syrup should immediately be scraped off without waiting for the surface to cool down. Otherwise the hob may be permanently damaged.**
 - Cleaning material that is suitable for ceramic hobs may damage other parts of your cooker, so take care with surrounding parts.

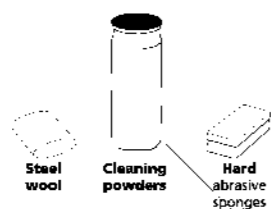

Control panel

Wipe over the control panel with a damp cloth and polish with a dry cloth. Do not use oven cleaners or aerosols, scouring pads or abrasive powder for cleaning the plastic knobs or end caps as damage will occur. Do not attempt to remove any of the control knobs from the panel as this may cause damage and is a safety hazard.

Grill interior

Wipe the grill elements with a damp cloth (ensuring they are sufficiently cool first) to remove any fat splashes. This will prevent fumes from any fat being burned off when the cooker is next used.

Oven interior

Remove the rod shelves for washing in the sink. Use a fine steel wool soap pad for removing stubborn stains from the rod shelves and floor of the oven. Take care during cleaning not to damage, bend or dislodge from the surrounding clips the thermostat sensor which is located at the top right hand side of the oven.

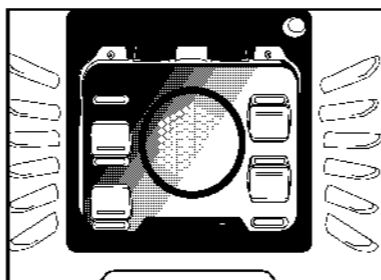

Catalytic liners should never require cleaning if very hot temperatures are used regularly.

Grill / Oven doors

Wipe over the door outer panels with a cloth wrung out in hot soapy water, then after wiping with a cloth wrung out in clean water, dry with a soft clean cloth. Do not use scouring pads or abrasive powder which may scratch the surface. Take care during cleaning not to damage or distort the door seal. Ensure that the door seal is dry after cleaning. Do not lift the door seal.

Levelling

The appliance should be located on a level surface. The two front feet can be adjusted as required. To ensure that your appliance is standing level adjust the two front feet by turning clockwise or anticlockwise until the product is in firm contact with the floor.

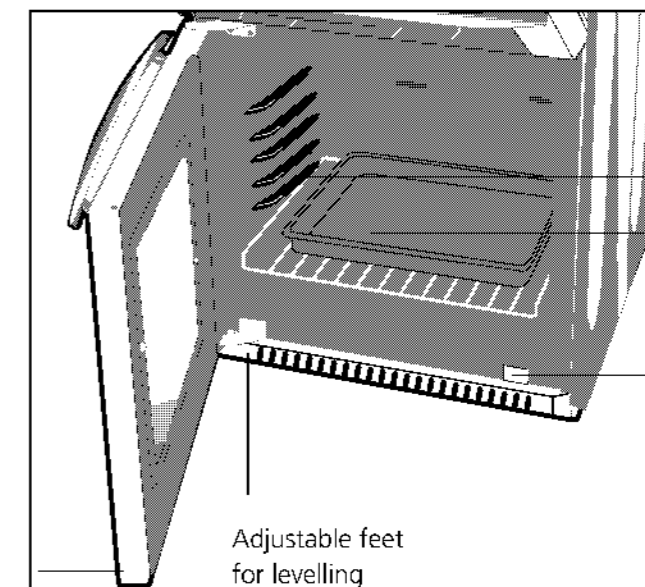

preparation and burning off



Important for asthmatic sufferers

Before using for the first time, protective coatings need to be burnt off. Fumes will be emitted but this is quite normal.

Ensure the room is very well ventilated during the burning off process. Avoid directly inhaling the fumes during this process.

Hotplates

Adjust the hotplates to the mid position and leave on for about 8 minutes. Do not place any pans or other cooking utensil on the hotplates during this process.

Grill

Open the grill door. Remove wire rack, baking tray and handle, and set the control to 200°C for about 15 minutes. Then close the door leave for a further 15 minutes.

Fan oven

Remove shelves and baking tray and turn the oven control knob to 200°C for about 15 minutes.

Cleaning

Before you start using your cooker, clean the appliance as recommended under Care and cleaning on page 19.

operating the hob

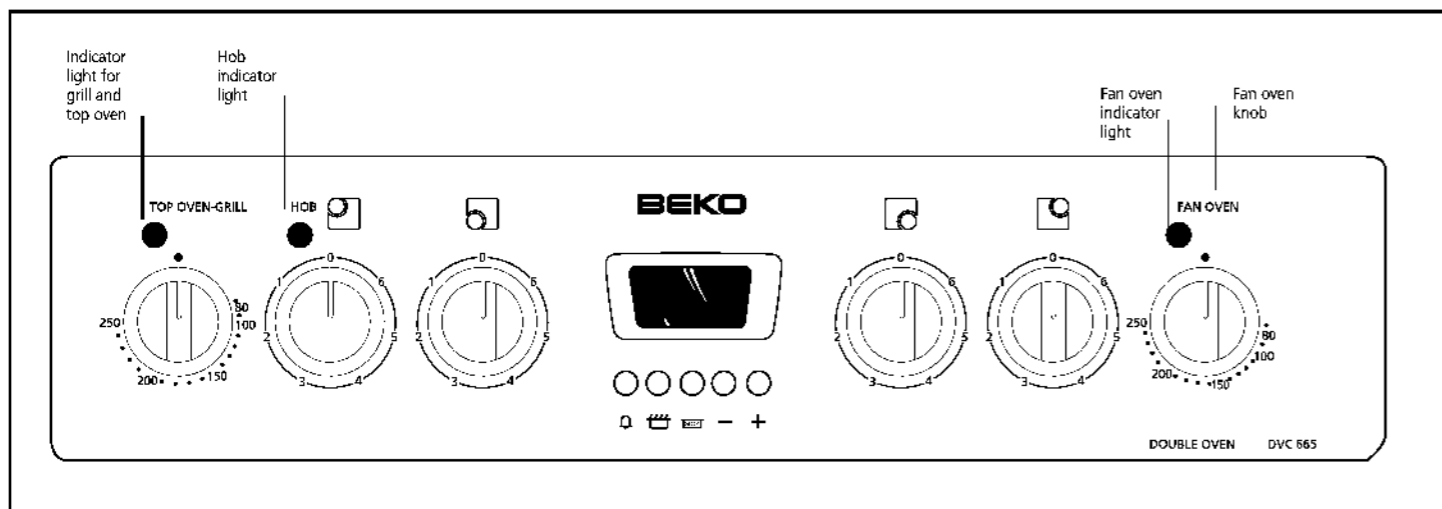

Control knobs

- 1 Rotate in either direction to switch on and select a heat level.
 - The four heating zones have 6 fixed positions.
- 2 When any one of the heating zones is on, the red indicator light on the control panel is on.
- 3 To switch a heating zone off turn the corresponding knob to 0.

Before retiring for the evening it is advisable to check that all the cooker controls have been switched off.

- A slight buzzing sound can be heard if any of the heating zones comes on. This is normal and not a fault.
- For best simmering, we recommend you use the rear left heating zone.

Rapid zone	Normal zone	Use
1	1	Warming
1, 2	2-3	Simmering
2, 3	4-5-6	Cooking-Frying-Boiling

Diameter 140mm 1200W Use 6" diameter saucepan Diameter 180mm 1700W Use 7" diameter saucepan

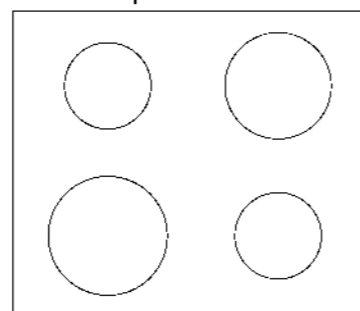

Diameter 180mm 1700W Rapid Use 7" diameter saucepan Diameter 140mm 1200W Use 6" diameter saucepan

Hob hot indicator lights

For your safety, these illuminate to show which hob is hot. They remain alight even when the hob is switched off. The light will go off when the temperature falls below 64°C.

Do not touch and keep children away from the heating zones and appliance at all times.

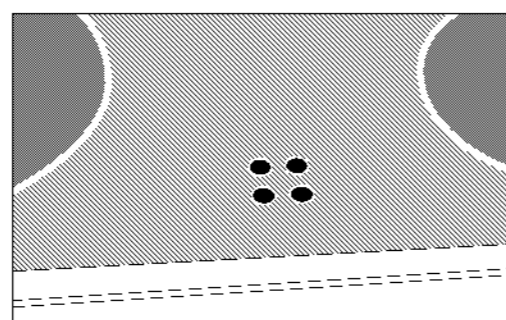

At the end of the cook period the **A** symbol will flash and an intermittent beeping sound will be heard. The symbol will go out. The beeping sound will continue for several minutes unless cancelled (see Step 6). The **A** symbol will continue to flash until the timer is returned to manual operation (see below).

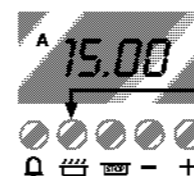

Step 6 Press the cook period button to cancel the beeping.

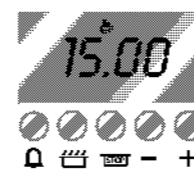

Step 7 Turn the oven control to the OFF position.

Step 8 Press the cook period and end time buttons together to return the cooker to manual operation. The **A** symbol will go out and the symbol will light up.

When cooking automatically the cook period can be checked at any time by simply pressing the cook period button. To cancel the auto cooking programme before or after automatic cooking starts, press the cook period and end time buttons together. This will return the cooker to manual operation.

A 16.20

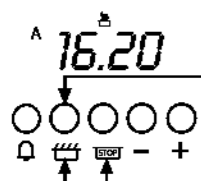

At the end of the automatic cook period the **A** symbol will flash and an intermittent bleeping sound will be heard. The  symbol will go out.

The bleeping sound will continue for several minutes unless cancelled (see step 8). The **A** symbol will continue to flash until the timer is returned to manual operation (see below).







Step 8 Press the  cook period button to cancel the bleeping sound.

Step 9 Turn the oven control to the OFF position.

Step 10 Press the  cook period and  end time buttons together to return the oven to manual operation. The **A** symbol will go out and the  symbol will light up.



Notes:

When cooking automatically the cook period can be checked at any time by simply pressing the  cook period button and the  end time button. To cancel the auto cooking programme before or after auto cooking starts, press the  cook period and  end time buttons together. This will return the cooker to manual operation.



(b) To set the timer to switch ON immediately and OFF automatically after a set cook period.

Step 1 Check that the correct time of day is set. If not follow instructions for setting the time of day.

Step 2 Place food onto the correct shelf position in the oven and close the oven door.

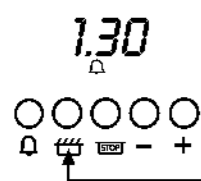
Step 3 Turn the oven control to the required temperature. The oven will automatically commence cooking..



Step 4 Press and hold the  cook period button, the display will read **0.00** and the  symbol will light up.



Note: The cook period is the length of time the food requires to cook.

With the cook period button still held set the required cook period using the "+" and "-" buttons the **A** symbol will light up. e.g. 1 hour 30 minutes.

Step 5 Release all buttons.

The timer display will revert to the time of day with the **A** and  symbols remaining lit.

Ceramic hob care

The ceramic glass surface is tough in everyday use and its flat surface makes it easy to clean but please follow the following precautions.



Immediately switch off the appliance from the mains if a crack is detected on the ceramic glass surface and refer to the Guarantee section.



Keep children away from hot surfaces.
In order to avoid hob soilage, make sure the bottom of the utensils and the hob surface are clean and dry before use.

Do not use the surface for food preparation eg cutting bread or slicing vegetables and fruit.

Do not use the surface for storing or any other non-cooking purpose.

- The scratching or dropping of sharp cornered pots onto the surface may cause damage.
- Do not place any material on the surface, such as plastic, aluminium, etc.
- Any such material that may have melted onto the surface should immediately be removed with a hob scraper.
- Never use a dishcloth or sponge to clean the ceramic hob as these may leave a layer of soiled detergent on the hob which will burn and discolour the next time the hob is used.
- Avoid heating up empty enamel pots.
- Splashes may damage the ceramic surface and can cause fire.

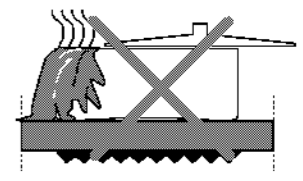

saucepan types

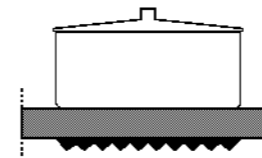

Optimum efficiency is achieved by using pans that match the diameters of the elements

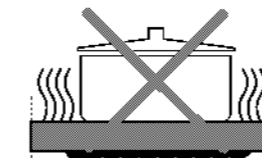

If the pan is too small energy is wasted.

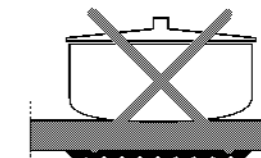

Do not use pots that have concave or convex bottoms.

- Do not use aluminum-bottomed pots. (This results in the deterioration of the ceramic glass surface).
- Use steel or heat-resistant glass pots. Do not use pots made from materials such as "boron glass", or "Pyrex", which are generally oven-type containers.

deep fat frying



- Never fill the pan more than one-third full of fat or oil.
- Never leave unattended during heating or cooking.
- Do not fry too much food at the same time especially frozen food. This only lowers the temperature of the oil or fat too much resulting in greasy food.
- Always dry food thoroughly before frying and lower it slowly into the hot oil or fat. Frozen foods in particular will cause frothing and spitting if added too quickly.
- Never heat fat or fry with a lid on the pan.
- Keep the outside of the pan clean and free from streaks of oil or fat.

In the event of a chip pan or other pan fire

- Switch off the electricity supply.
- Smother flames with a fire blanket or damp cloth.
Burns and injuries are caused almost invariably by picking up the burning pan and rushing outside with it.



Do not use water on the fire.
Leave the pan to cool for at least 30 minutes.

operating the grill/top oven

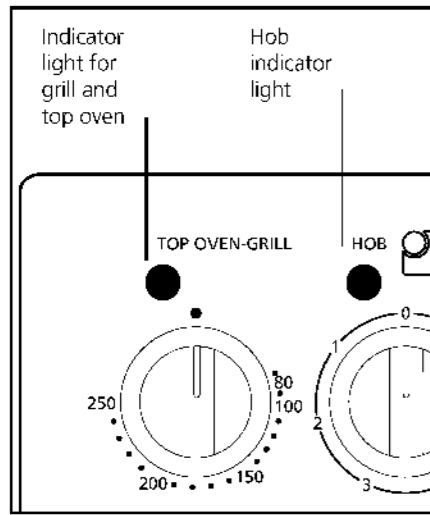

Don't touch the heating elements or other parts that may become hot when the grill/top oven is in use - children must be kept away!

A switch operated by the door changes the heating element configuration between grill and oven operation. When the door is open, the top inner element is activated for intense downward heat; when the door is closed, the top outer and lower elements are activated to provide even oven heating.

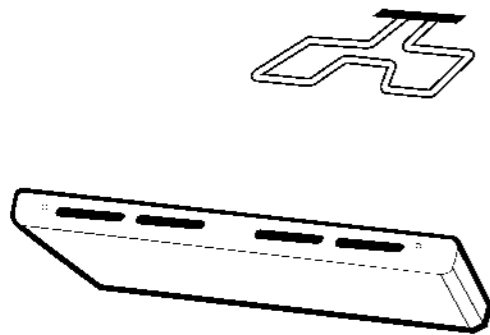

As a grill door open

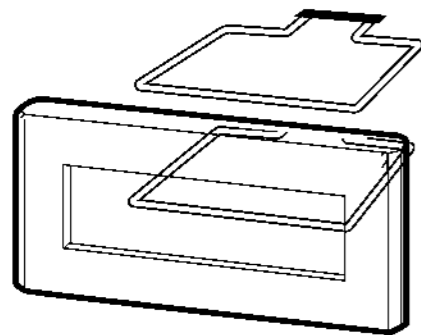

As an oven door closed (lower element is concealed)

Using as a grill

When the door is fully open, it remains tilted slightly, so that any spillage will be directed away from you.

1 Open the door.

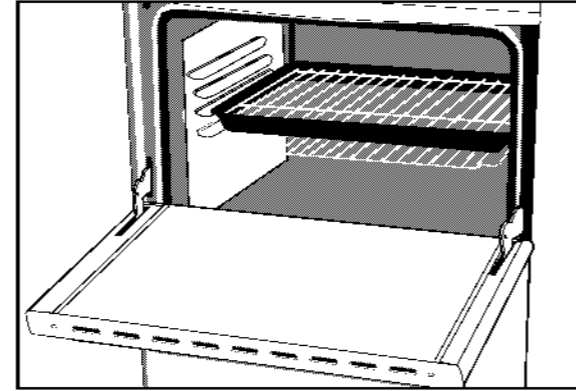

- 2 Turn the grill on by turning the control knob to 150°C and allow to preheat for around 5 minutes.
- 3 The red indicator light will glow to show that the grill has been switched on.
- 4 Then choose the desired setting.
- 5 To turn the grill off by rotating the control anti-clockwise to the • mark.

- **Only use the middle and bottom rack position for grilling. Do not use the top position.**
- Ensure the food is correctly positioned under the grill element.
- Food which requires browning only should be placed under the hot grill, either in the grill pan, or on the floor of the grill compartment, according to the depth of the dish. The grill pan wire grid can be removed.
- Do not line the grill pan with aluminium foil.
- Plates and dishes placed on the floor of the grill compartment will be heated when the main oven is in use.
- Do not switch on the grill when using the compartment for storage.

Grilling guidelines

Use the 230° position for toast, for sealing and fast cooking of foods.

For thicker foods requiring longer cooking, turn the control to a lower setting after the initial sealing on both sides. The thicker the food, the lower the control should be set. When grilling thicker food, the grill rack should be turned over to its lowest position.

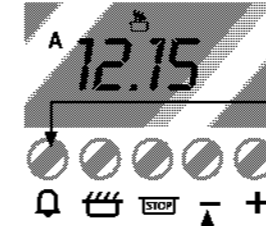

To cancel the minute minder before the minute minder period has finished.

Step 1 Press the minute minder button.

Step 2 Press the "-" button until 0.00 and the symbol appears in the display window.

Step 3 To cancel the beeping sound press the minute minder button.

Automatic Cooking Programmes

The main oven only is programmable.

When the timer has been set for the main oven it is possible to use the top oven manually during the same automatic programme.

There are two automatic cooking programmes that can be selected using your timer:

- (a) To set the timer to switch the oven ON and OFF automatically.
- (b) To set the timer to switch on immediately and OFF automatically after a set cook period.

(a) To set the timer to switch the oven ON and OFF automatically.

This allows you to cook at a specific time for a chosen period before the oven switches off automatically.

Step 1 Check that the correct time of day is set. If not follow instructions for setting the time of day.

Step 2 Place food onto the correct shelf position in the oven and close the oven door.

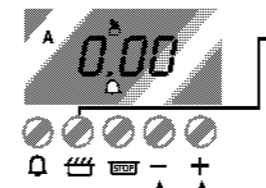

Step 3 Press and hold the cook period button. The display will read 0.00 with the cookpot symbol lit.

Step 4 With the cook period button still held in set the required cook period using "+" and "-" buttons.

Release the buttons and the timer display will revert to the time of day with the **A** symbol and symbol lit.

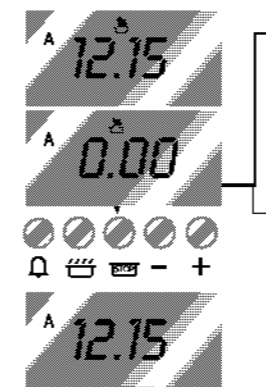

Step 5 Press and hold the end time button. The display will read the earliest possible time for the cook period that you have set above.

Step 6 With the end time button still held in, use the "+" and "-" buttons to set the end time. **i.e.** The time you require the oven to switch off and the food is cooked.

Release all the buttons and the timer will revert back to the time of day.

The **A** symbol will remain lit to signify that an automatic cooking programme has been set. The symbol will go out.

Step 7 Turn the oven control to the required temperature.

When the auto cook programme starts the symbol will then light up again.

Setting the Time of Day

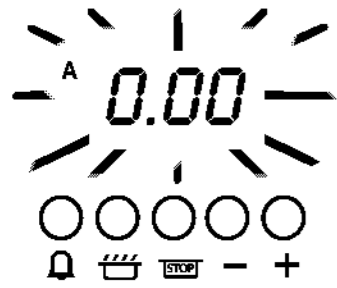

Step 1 Make sure all oven controls are turned **OFF**.

Step 2 Check the electricity supply to the cooker is turned **ON**.

When switched on the display will show **0.00** and the **A** symbol, both will be flashing.

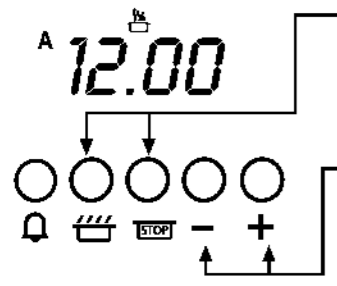

Step 3 Press hold in both the grill icon & stop end time buttons together.

Step 4 With the grill icon & stop end time buttons still held in, press either + or - buttons to set to correct time of day.

Step 5 Release all the buttons simultaneously.

The time of day is now set and the grill icon symbol will light up to show that the timer is in Manual Mode.

NOTE: To change the time of day repeat steps 3, 4 & 5 above.

Setting the Minute Minder

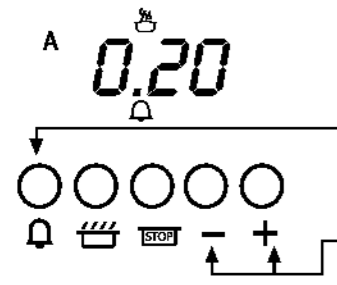

Step 1 Ensure the time of day is set correctly.

Step 2 Press and hold the alarm bell icon minute minder button.

Step 3 With the button still held in set the required minute minder time using "+" and "-" buttons. **A** alarm bell icon symbol will light up.

Step 4 Release all buttons and the timer display will revert back to the time of day.

The alarm bell icon symbol will remain lit to signify that a minute minder period has been set.

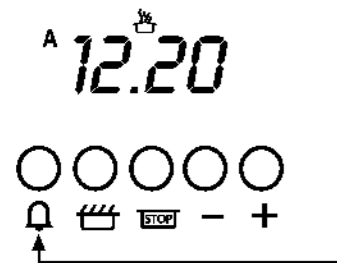

At the end of the set time a bleeping sound will be heard and the alarm bell icon symbol will go out. The bleeping sound will continue for several minutes unless cancelled (See Step 5)

Step 5 To cancel the bleeping sound press the alarm bell icon minute minder button. The time display will revert back to the time of day after the button is released.

Use of grill pan handle



Warning! Always use an oven glove to protect your hand when using the grill as all metal parts can become very hot.

The grill pan has a detachable handle. Make sure the handle is securely located between the raised profiles across the front of the grill pan. See the diagrams for fitting the handle. To remove the handle, reverse the sequence of operations.



Always take care not to touch hot surfaces when using the grill pan handle. Ensure when using the grill pan handle that it is centralised and secure. Do not leave the handle in position when grilling, it will get very hot.

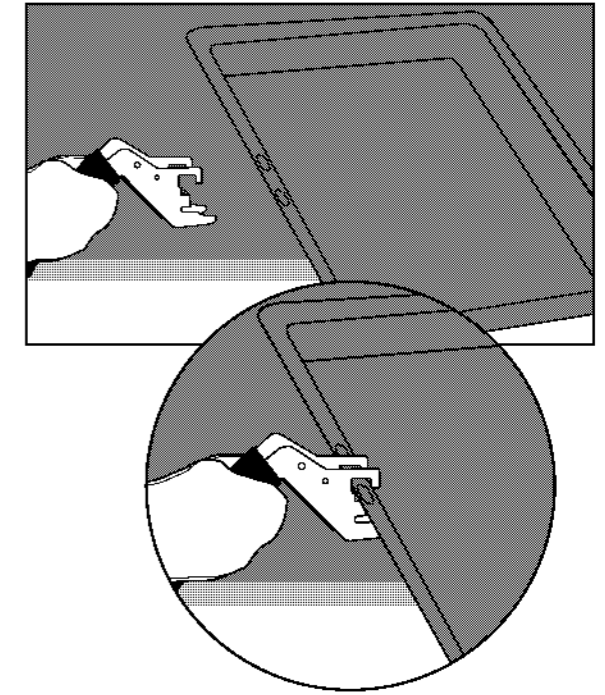

Using as an oven

- 1 Turn the oven on by rotating the top oven control knob clockwise.
- 2 Select the temperature in the oven by selecting the temperature (in degrees Celsius) printed on the knob.
- 3 The amber temperature indicator light on the control panel will glow until the pre-set temperature is reached.
- 4 Once the temperature has been reached, the amber light will go off and then cycle on and off to maintain the pre-set temperature.
- 5 To turn the oven off by rotating the control knob anti-clockwise to the ● mark.
 - Take care when opening the door. Let steam and hot air escape before removing the food.

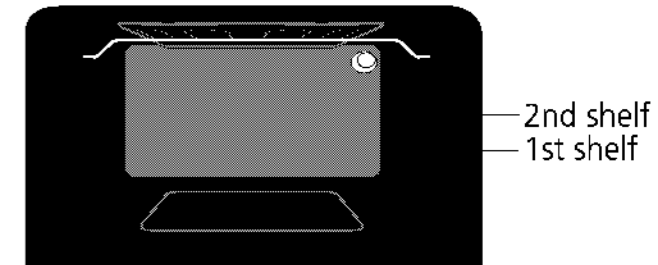

Top oven temperature chart

This chart is for guidance only, follow food manufacturers recommendations whenever available.

There is a temperature conversion chart in the Fan Oven section.

Food	Cooking temperature °C	Time	Shelf position
Beef	170-180	30 mins per 450g +30 mins	1
Lamb	180-190	30 mins per 450g + 30 mins	1
Pork	170-190	30 mins per 450g + 30 mins	1
Poultry	170-190	25-30 mins per 450g + 25 mins	1
Casseroles	140-160	1.5-2 hours dependent on quantity	1
Fruit cake	140-160	Time dependent on size	1
Small cakes	160-180	20-25 mins	2
Victoria sandwich	160-180	20-25 mins	1

! Don't touch the heating elements or other parts that may become hot when the fan oven is in use children must be kept away!

- 1 Turn the oven on by rotating the oven control knob clockwise.
- 2 Select the temperature in the oven by selecting the temperature (in degrees Celsius) printed on the knob.
- 3 The amber temperature indicator light on the control panel will glow until the pre-set temperature is reached.
- 4 Once the temperature has been reached, the amber light will go off and then cycle on and off to maintain the pre-set temperature.
- 5 To turn the oven off rotate the oven control anti-clockwise to the ● mark.

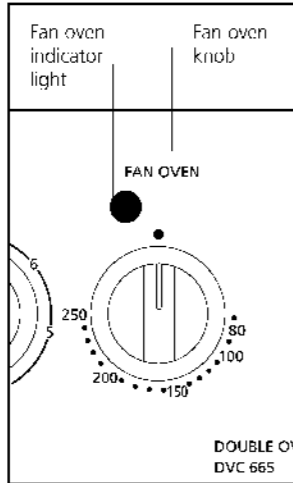

Temperature conversion

The oven temperature control knob is marked in degrees Celsius (sometimes called Centigrade). This chart will help when recipes show °F or use descriptive terms (as recommended by the Association of Manufacturers of Domestic Electrical Appliances).

Description	Celsius °C	Fahrenheit °F
Cool	70	150
	80	175
	100	200
	110	225
Slow	120	250
	140	275
	150	300
Fairly hot	160	325
	180	350
	190	375
Hot	200	400
	200	400
Very hot	220	425
	230	450
	250	480

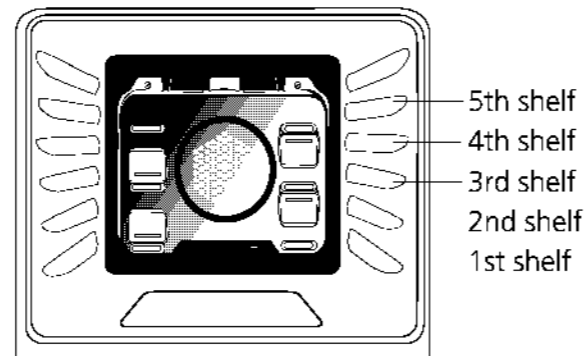

- ! Ensure you stand back from the appliance when opening the oven door to allow any build up of steam or heat to escape.**
- Check food is thoroughly cooked and is piping hot.
 - As a fan oven heats up more quickly and generally cooks food at a lower temperature than a conventional oven, preheating the oven is often unnecessary. However, food such as bread, scones and Yorkshire pudding, do benefit from being placed in a pre-heated oven.

Fan oven temperature chart

This chart is for guidance only, follow food manufacturers recommendations whenever available.

Food	Cooking temperature °C	Time	Shelf position
Beef	160-180	20-25 mins per 450g +20 mins	2
Lamb	160-180	25 mins per 450g + 25 mins	2
Pork	160-180	25 mins per 450g + 25 mins	1-2
Poultry up to 4kg (8lbs)	160-180	18-20 mins per 450g + 20 mins	1-2
Poultry up to 5.5kg (12lbs)	150-160	14-16 mins per 450g + 20 mins	1-2
Casseroles	140-150	1.5-2 hours dependent on quantity	1-2
Fruit cake	130-140	Time dependent on size	2-3
Small cakes	160-180	15-25 mins	4
Victoria sandwich	160-180	20-25 mins	1

! The timer display is in 24 hour clock format.

Ensure that the correct time of day is always set before using your cooker. The clock must be set before the oven can be operated.

- A** will light:
- When the timer is first turned on it will flash. (It should go out when the time of day is set).
 - When an Auto Cooking programme has been set.

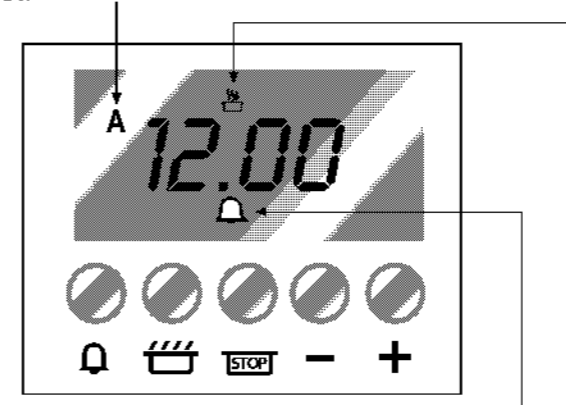

☑ This "Cookpot" symbol will light up either.

- When the cooker is in "Manual Mode".
- When you press the ☑ Cook Period button and set a length of time for an Automatic Cooking programme.

☑ symbol will light up during Automatic Cooking.

🔔 will light up when you select a Minute Minder period and will remain on for the period set.

🔔 minute minder

Here you can set a time period of up to 23 hours and 59 minutes that will count down. When it reaches zero the timer will bleep. e.g. If you set 20 minutes, the timer will start beeping 20 minutes later.

☑ cook period

Cook Period is the actual length of time for which, the timer will switch the oven on as part of an "Automatic Cooking" programme. e.g. If you set 2 hours, the food will be cooked for 2 hours.

🛑 end time

The time of day at which you want an automatic cooking programme to **end**.
e.g. If you set a cook period for 2 hours, and end time of 11:00. The timer will switch the oven on at 9:00 and turn the oven off at 11:00. You will hear a bleep at 11:00 to indicate that the automatic cooking programme has finished.

Notes

- When setting an automatic cooking programme you will need to set the oven control to the required temperature when you set the timer.
- If an automatic cooking programme has been set the oven will only operate during the pre-programmed time.

"+" and "-"

- Used to adjust the various timer function settings.
- Used to adjust pitch of audible tone.