



REFRIGERATION

FCF55W

Chest Freezer

Operating
Instructions

Please read these instructions first before using your appliance

Thank you for choosing a Flavel appliance.

Please take some time to read this user manual before using your appliance, to ensure you know how to safely operate the controls and functions. Carefully follow all unpacking and installation instructions to ensure the appliance is correctly connected and fitted prior to use.

Please write your product model and serial number on the last page of this user manual, and store in a safe location close to the appliance for easy future reference.

This user manual may also be applicable for several other models. Differences between models will be listed.

If you have any questions or concerns, please call our contact centre or find help and information online at www.flavelappliances.com

Recycling



This product bears the selective sorting symbol for waste electrical and electronic equipment (WEEE).

This means that this product must be handled pursuant to European Directive 2002/96/EC in order to be recycled or dismantled to minimize its impact on the environment.

For further information, please contact your local or regional authorities.



Electronic products not included in the selective sorting process are potentially dangerous for the environment and human health due to the presence of hazardous substances.

Congratulations on your choice of a FLAVEL quality Appliance which has been designed to give you service for many years.

WARNING!

This appliance is not intended for use by person with reduced physical, sensory or mental capabilities or lack of experience and knowledge unless they have been given supervision or instruction concerning use of the appliance by a person responsible for their safety. Children should be supervised to ensure that they do not play with the appliance.

IMPORTANT !

DO NOT connect the appliance to the electricity supply until all packing and transit protectors have been removed.

- Leave to stand for at least 4 hours before switching on to allow compressor oil to settle if transported horizontally.
- If you are discarding an old product with a lock or latch fitted to the lid, ensure that it is left in a safe condition to prevent the entrapment of children.
- This freezer must only be used for its intended purpose i.e the storing and freezing of edible foodstuff.
- Do not dispose of the appliance on a fire. At FLAVEL, the care and protection of our environment is an ongoing commitment. This appliance which is among the latest range introduced is particularly environmentally friendly. Your appliance contains non CFC/HFC natural substances in the cooling system (Called R600a) and in the insulation (Called cyclopentane) which are potentially flammable if exposed to fire. Therefore, take care not to damage, the cooling circuit / pipes of the appliance in transportation and in use. In case of a damage do not expose the appliance to fire, potential ignition source and immediately ventilate the room where the appliance is situated.
- We suggest you contact your local authority for disposal information and facilities available.
- To obtain the best possible performance and trouble free operation from your appliance it is very important to carefully read these instructions.
- On delivery, check to make sure that the product is not damaged and that all the parts and accessories are in perfect condition.
- We do not recommend the use of extension leads and multi-way adapters.
- Failure to observe these instructions may invalidate your right to free service during the guarantee period.

WARNING ! Do not use mechanical devices or other means to accelerate the defrosting process, other than those recommended by the manufacturer.

WARNING ! Do not damage the refrigerant circuit.

WARNING ! Do not use electrical appliances inside the food storage compartments of the appliance, unless they are of the type recommended by the manufacturer.

- We suggest you keep these instructions in a safe place for easy reference.

 CHEST FREEZER FCF55W	
PERFORMANCE	
Energy efficiency class	A+
Energy consumption - Kwh/year	173
Net storage – vol fresh food ltrs (cu.ft.)	-----
Net storage – vol frozen food ltrs (cu.ft.)	104 (3.6)
Total net vol – ltrs (cu.ft.)	104 (3.6)
Frozen food compartment rating	4 STAR
Conservation time from failure	30 hrs.
Freezing capacity fresh food – kg (lb) /24 hrs.	8 (17.6)
Climate class	SN-T
Operating noise level [dB(A) re1pW]	41

CONTENTS	PAGE
TRANSPORTATION INSTRUCTIONS	3
INSTALLATION INSTRUCTIONS	4
STARTING	5
FREEZER OPERATION	6
STORING FROZEN FOOD	7
FREEZING FRESH FOOD	7
DEFROSTING	8
CLEANING AND CARE	8
DO'S AND DON'TS	9
PROBLEM SOLVING/TROUBLE SHOOTING	9
GUARANTEE DETAILS	10
HOW TO OBTAIN SERVICE	13

TRANSPORTATION INSTRUCTIONS

1. The appliance should be transported only in a vertical upright position. The packing as supplied must be intact during transportation.
2. If during the course of transport the product has been transported horizontally, it must only be laid on its left hand side (when facing the lid front) and it must not be operated for at least 4 hours to allow the system to settle after the appliance is brought back to upright position.
3. For the protection of the appliance during warehousing and transport, it is provided with spacers between the lid and the cabinet (in the front and rear side). These spacers will be removed before putting the appliance into operation.
4. Failure to comply with the above instructions could result in damage occurring to the appliance. The manufacturer will not be held responsible if these instructions are disregarded.
5. The appliance must be protected against rain, moisture and other atmospheric influences.

IMPORTANT : Care must be taken while cleaning / carrying the appliance to avoid touching the condenser metal wires at the back of the appliance, as you might injure your fingers and hands or damage your product.

IMPORTANT : This appliance is not designed for stacking with any other appliance. Do not attempt to sit or stand on top of your appliance as it is not designed for such use. You could injure yourself or damage the appliance.

IMPORTANT : Make sure that mains cable is not caught under the appliance during and after carrying / moving the appliance, to avoid the mains cable becoming cut or damaged.”

IMPORTANT : Excess deposit of ice on the frame and the baskets should be removed regularly with the plastic scraper provided. Do not use any metal parts to remove the ice.

The presence of this ice build-up makes impossible to close the lid correctly.

When positioning your appliance take care not to damage your flooring, pipes, wall coverings etc. Do not move the appliance by pulling by the lid or handle. Do not allow children to play with the appliance or tamper with the controls. BEKO plc. declines to accept any liability should the instructions not be followed.

INSTALLATION INSTRUCTIONS

1. If possible avoid placing the appliance near cookers, radiators or in direct sunlight as this will cause the compressor to run for long periods. If installed next to a source of heat or refrigerator, maintain the following minimum side clearances:

From Cookers	4" (100 mm)
From Radiators	12" (300 mm)
From Fridges	4" (100 mm)

2. Make sure that sufficient room is provided around the appliance to ensure free air circulation. Ideally, ensure you allow gaps as shown in the below diagram.

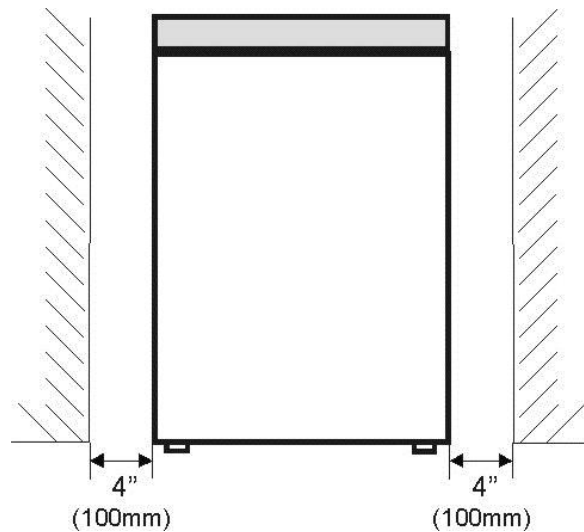

3. The appliance should be located on a smooth surface.
4. Refer to "Cleaning and Care" section to prepare your appliance for use.
5. Fit the two plastic wall spacer supplied with the appliance rotating 1/4 turn to the condenser at the back of the freezer (see diagram).

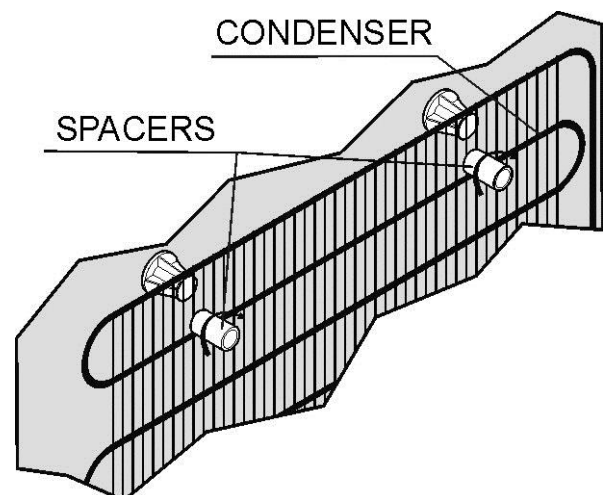

6. If the freezer is installed in unheated areas, garages etc., in cold weather condensation may form on the outer surfaces. This is quite normal and is not a fault. Remove the condensation by wiping with a dry cloth.

STARTING

Final Check

Before you start using the freezer check that:

1. The interior is dry and air can circulate freely at the rear.
2. Clean the interior as recommended under "CLEANING AND CARE".
3. Insert the plug into the wall socket and switch on the electricity supply. Avoid accidental disconnection by taping over the switch. Green light will glow and the compressor will start running (see Freezer Operation page 6).
4. You will hear a noise as the compressor starts up. The liquid and gases sealed within the refrigeration system may also give rise to noise, whether the compressor is running or not which is quite normal.
5. If you going to store already frozen food open the freezer lid and check that the freezer has reached the correct temperature. Then you can put in your already frozen food. (See Storing Frozen Food page 7).
6. If you are going to freeze fresh Food, you should turn the knob to Superfreeze position, wait for at least three hours before putting in your fresh food to be frozen. (See Freezing Fresh Food, Page 7).
7. Do not load the appliance immediately after it is switched on. Wait until the correct storage temperature has been reached. We recommend that you check the temperature with an accurate thermometer (see Freezer Operation page 6).

Important Notes:

- If there is a power failure do not open the lid. Frozen food should not be affected if the failure lasts for less than 30 hours. If the failure is longer, then the food should be checked and eaten immediately or cooked and then refrozen.
- If you find that the lid of the chest freezer is difficult to open just after you have closed it, don't worry. This is due to the pressure difference which will equalize and allow the lid to be opened normally after a few minutes.

WARNING: When positioning the appliance ensure the supply cord is not trapped or damaged.

WARNING: Do not locate extension sockets or charging transformers/power supplies or Lithium-Iron battery operated products adjacent to the compressor as they could overheat.

FREEZER OPERATION

Temperature adjustment

The temperature of the freezer is adjusted by means of the knob assembled on the thermostat, position „MAX” being the lowest temperature.

The achieved temperatures can vary according to the conditions of use of the appliance, such as: place of the appliance, ambient temperature, frequency of lid opening, extent of filling with food of the freezer. The position of the thermostat knob will change according to these factors. Normally, for an ambient temperature of approx. 22°C, the thermostat should be adjusted to the mild position.

We recommended that you check the temperature with a thermometer to ensure that the Freezer is kept to the desired temperature. Remember you must take your reading very quickly since the thermometer temperature will rise very rapidly after you remove it from the freezer.

Please remember each time the lid is opened cold air escapes and the internal temperature rises. Therefore never leave the lid open and ensure it is closed: immediately after Food is put in or removed.

Indicator lights

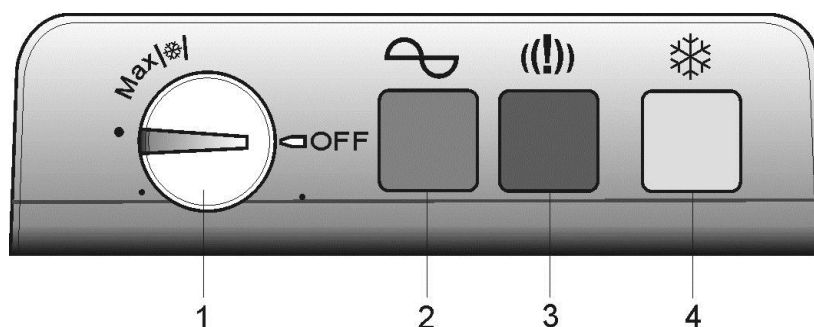

The indicator light set is placed on the back side of the freezer for easy visibility.

By using the Thermostat Adjustment Knob (1), you can adjust the internal temperature of the freezer.

Indicator lights mean the following:

- green LED - shows that the appliance is supplied with electric energy.
- red LED - lights if the temperature in the freezer is too high. The LED will operate 45 minutes after putting into operation of the freezer, then it must go off. If the LED comes on during the operation, this may mean that a defect has occurred.
- orange LED - fast freeze function activated - by setting the knob to Superfreeze position the orange LED goes on, showing that the appliance entered into the "fast freeze" mode. The exit of this mode is done automatically after 50 hours then the appliance runs in economic mode, and the orange LED goes off.

STORING FROZEN FOOD

Prepackaged commercially frozen food should be stored in accordance with the frozen food manufacturer's instructions for a  freezer compartment.

To ensure that the high quality achieved by the frozen food manufacturer and the food retailer is maintained the following should be remembered:

1. Put packets in the freezer as quickly as possible after purchase.
2. Do not exceed "Use By", "Best Before" dates on the packaging.

FREEZING FRESH FOOD

Place fresh food to be frozen near the side walls to ensure fast freezing and away from already frozen food, if possible.

Freezing capacity of your appliance in a 24 hours period is 8 kg (17.6 lb).

Never exceed this maximum capacity. If you are going to freeze fresh food in excess of 2 kg. (4.5 lb) turn the knob to Superfreeze position on and wait for at least three hours before placing the fresh food in the freezer. Do not freeze too large a quantity at any one time.

The quality of the food is best preserved when it is frozen right through to the centre as quickly as possible.

Take special care not to mix already frozen food and fresh food.

1. Basket
2. Control panel

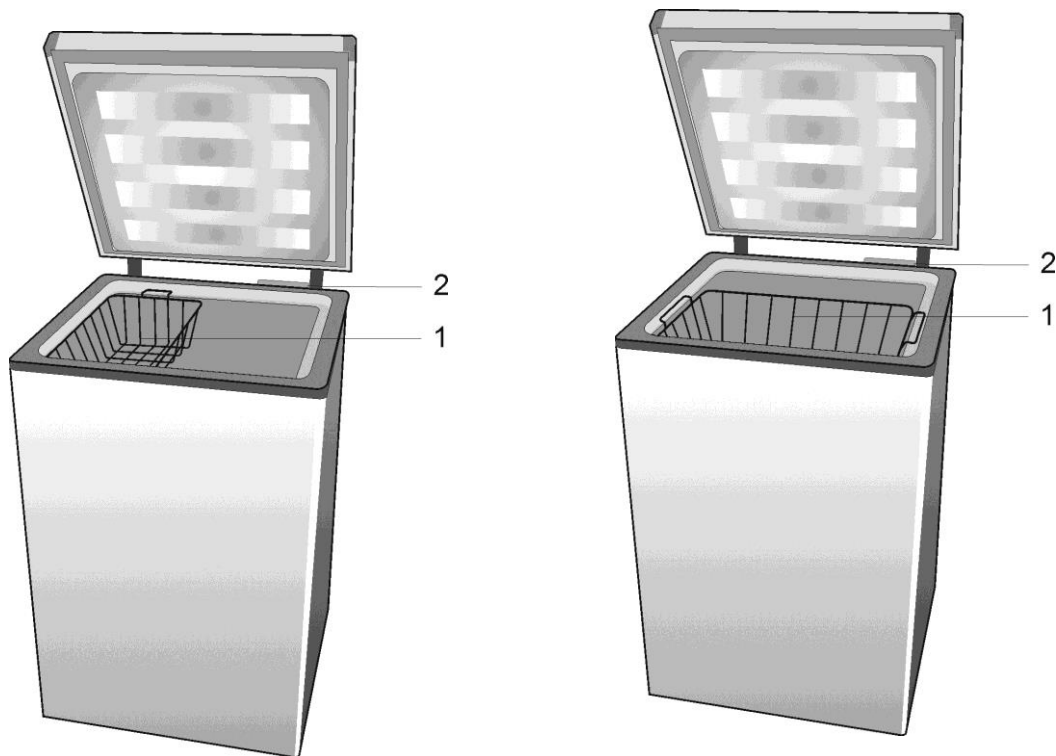

 Figures that take place in this instruction manual are schematic and may not correspond exactly with your product. If the subject parts are not included in the product you have purchased, then it is valid for other models.

DEFROSTING

Defrost twice a year or when a frost layer of around 7 mm (1/4") has formed.

To start the defrosting procedure turn the thermostat knob to zero position.

Alternatively you may switch off the freezer at the socket outlet and pull out the mains plug.

All food should be wrapped in several layers of newspaper and stored in a cool place (e.g. fridge or larder).

Remove the freezer basket. Leave the lid open. Containers of warm water may be placed carefully in the freezer to speed up the defrosting.

Do not use pointed or sharp-edged objects such as knives or forks to remove the frost.

Never use hairdryers, electrical heaters or other such electrical appliances for defrosting.

When defrosting has finished sponge out defrost water which collects at the bottom of the freezer and dry the interior thoroughly. Switch on the Fast Freeze and leave it on for about three hours.

CLEANING AND CARE

** We recommend that you switch off the freezer at the socket outlet and pull out the mains plug before cleaning.

** Never use any sharp abrasive instrument, soap, household cleaner, detergent and wax polish for cleaning.

** Use luke warm water to clean the cabinet of the freezer and wipe it dry.

** Use a damp cloth wrung out in a solution of one teaspoon of bicarbonate of soda to one pint of water to clean the interior and wipe it dry.

** Excess deposit of ice should be removed on a regular basis using a plastic ice scraper available from your local store. Large accumulation of ice will impair the performance of the freezer.

** If the freezer is not going to be used for a long period of time switch it off, remove all food, clean it and leave the lid ajar.

** Any dust that gathers on the condenser, which is located at the back of the freezer, should be removed once a year with a vacuum cleaner.

** Check lid seals regularly to ensure they are clean and free from food particles.

DO'S AND DON'TS

- Do** – Defrost food from the freezer thoroughly in a fridge or in a microwave oven following defrosting and cooking instructions.
- Do** – Ensure that chest freezer lid is completely closed after each use.
- Do** – Defrost frozen meat completely before cooking.
- Do** – Close the lid gently.
- Do** – Check contents of the freezer at regular intervals.
- Do** – Clean and defrost your freezer regularly (See “Defrosting”)
- Do** – Keep food for as short a time as possible and adhere to “Best Before”, “Use By” dates.
- Do** – Store commercially frozen food in accordance with the instructions given on the packets that you buy.
- Do** – Always choose high quality fresh food and be sure it is thoroughly clean before you freeze it.
- Do** – Prepare fresh food for freezing in small portions to ensure rapid freezing.
- Do** – Wrap all foods in aluminium foil or freezer quality plastic bags and make sure any air is excluded.
- Do** – Wrap frozen food when you buy it and put it in to the freezer as soon as possible.
- Do** – Store small items in the basket provided.
- Do** – Remove ice cream from the freezer 10-20 minutes before serving.
- Don't** – Leave the lid open for long periods as this will make the freezer more costly to run and cause excessive ice formation.
- Don't** – Use pointed sharp edged objects such as knives, forks to remove the ice.
- Don't** – Put hot food in the freezer. Let it cool down first.
- Don't** – Put liquid-filled bottles or sealed cans containing carbonated liquids into the freezer as they may burst.
- Don't** – Store poisonous or dangerous substances in the freezer. Your freezer has been designed for the storage of edible foodstuffs only.
- Don't** – Exceed the maximum freezing capacity (8 kg in any 24 hours) when freezing fresh food.
- Don't** – Consume ice-cream and water ices direct from the freezer. The low temperature may cause ‘freezer burns’ on lips.
- Don't** – Freeze fizzy drinks.
- Don't** – Try to keep frozen food which has thawed, it should be eaten within 24 hours or cooked and refrozen.
- Don't** – Remove items from the freezer with wet hands.
- Don't** – Shut the lid with force. You will damage the appliance.

PROBLEM SOLVING/TROUBLE SHOOTING

- If the appliance does not operate when switched on, check;
- The plug is inserted properly in the socket and that the power supply is on. (To check the power supply to the socket, plug in another appliance)
- The fuse has blown / circuit breaker has tripped / main distribution switch has been turned off.
- The temperature control has been set correctly.
- New plug is wired correctly if you have changed the fitted moulded plug. If the appliance is still not operating after the above checks, please refer to the section on “How To Obtain Service”.

Please ensure that above checks have been made as a charge will be made if no fault is found.

FLAVEL UK AND IRELAND STANDARD MANUFACTURER GUARANTEE TERMS AND CONDITIONS

Your new Flavel product is guaranteed against faulty materials, defective components or manufacturing defects.

The standard guarantee starts from the date of original purchase of the product, and lasts for a period of twelve (12) months unless Beko plc (the “Manufacturer”) agrees to extend the guarantee for the product in writing.

If you have any questions about the guarantee on your product (including how long it is valid), please contact your retailer or our contact centre on **0333 207 9894** (UK and Northern Ireland) or **01 691 0164** (Republic of Ireland)

This guarantee does not in any way diminish or affect your statutory rights in connection with the product. This guarantee is in addition to your statutory rights as a consumer. If you have any questions about these rights, please contact the retailer from which you purchased the product. In certain circumstances, it is possible that your statutory rights may offer additional or higher levels of protection than those offered under the terms of this guarantee.

What is covered by this guarantee?

- Repairs to the product required as a result of faulty materials, defective components or manufacturing defects.
- Functional replacement parts to repair a product.
- The costs of a Flavel Approved Engineer to carry out the repair.

What is not covered?

- Transit and delivery damage.
- Cabinet or appearance parts, including but not limited to control knobs, flaps and handles.
- Accessories and/or consumable items including but not limited to ice trays, scrapers, cutlery baskets, filters and light bulbs.
- Repairs necessary as a direct or indirect result of:
 - Accidental damage, misuse or abuse of a product.
 - An attempted repair of a product by anyone other than a Flavel Approved Engineer (the “Engineer”).
 - Installation or use of a product where such installation or use fails to meet the requirements contained in this guarantee or the User Instructions Booklet.
- Repairs to a product operated at any time on commercial or non-residential household premises (unless we have previously agreed to the installation environment).

This guarantee is limited to the cost of repairing the product. To the extent permitted by law, the Manufacturer does not accept and will not be held liable for any financial loss incurred in connection with the failure of any product to operate in accordance with the expected standards. Such financial loss includes but is not limited to loss arising from:

- Time taken off work.
- Damaged food, clothing or other items.
- Meals taken at restaurants or from takeaways.
- General compensation for inconvenience.

Important Notes

1. Your product is designed and built for domestic household use only.
2. The guarantee will automatically be void if the product is installed or is used in commercial or non-residential domestic household premises, unless we have previously agreed to the installation environment.
3. The product must be correctly installed, located and operated in accordance with the instructions contained in the User Instructions Booklet provided with your product.
4. Professional installation by a qualified Electrical Domestic Appliance Installer is recommended for all Washing Machines, Dishwashers and Electric Cookers (as incorrect installation may result in you having to pay for the cost of repairing the product).
5. Gas Cookers must be professionally installed by a Gas Safe (or Gas Networks Ireland for Republic of Ireland) registered gas installer.
6. This guarantee is given in respect of products purchased and used within the United Kingdom and the Republic of Ireland.
7. This guarantee is effective from the initial date of purchase of a new product from an authorised retailer and will be void if the product is resold.
8. This guarantee does not apply to graded sales (where the product is purchased as a "second").
9. Possession of a copy of these terms and conditions does not necessarily mean that a product has the benefit of this guarantee. If you have any questions, please call our Call Centre on the number set out above.
10. The Manufacturer reserves the right to terminate the guarantee if its staff or representatives are subjected to physical or verbal abuse in the course of carrying out their duties.
11. Optional extras, where available (i.e. extendable feet) are supplied on a chargeable basis only.

Does Flavel offer replacements?

This is a repair-only guarantee. On occasion, the Manufacturer may at its sole discretion, replace your product with a new product instead of carrying out a repair. Where a replacement is offered, this would normally be an identical model but when this is not possible, a model of similar specification will be provided. The Manufacturer will cover the costs and arrange for the delivery of the new product and for the return of the old product. Any costs related to disconnecting the faulty product and installing the replacement product will not be borne by the Manufacturer unless previously agreed to in writing. The original guarantee will continue to apply to the replacement product; the new product will not come with a new guarantee.

When will the repair take place?

Our Engineers work Monday to Friday 9.00am to 5.00pm. Appointments outside these hours may be possible at the sole discretion of the Manufacturer but cannot be guaranteed. Whilst our Engineers will endeavour to minimize inconvenience and to meet requests for specific timed appointments, this cannot be guaranteed. We will not be liable for delays or if it is unable to carry out a repair because a convenient appointment cannot be arranged.

Will there be any charge for the repairs?

It is your responsibility to provide evidence to the Engineer that your product is covered by this guarantee with a proof of purchase. The Manufacturer reserves the right to charge for the reasonable cost of any service call if:

- You cannot provide evidence that your product is covered by this guarantee.
- Where a service call has been made and the engineer finds that there is no fault with your product.
- That your product has not been installed or operated in accordance with the User Instructions Booklet.
- That the fault was caused by something other than faulty materials, defective components or manufacturing defects.
- For missed appointments.

Payment of these costs are due immediately upon the Engineer providing you with an invoice. The Manufacturer reserves the right to terminate the guarantee if you fail to pay the costs for the service call in a timely manner.

If you are a resident of the United Kingdom, this guarantee will be governed by English law and subject to the English Courts, save where you live in another part of the United Kingdom, in which case the law and courts of that location will apply.

If you are resident in the Republic of Ireland, this guarantee will be governed by Irish law and the Irish courts will have jurisdiction.

This guarantee is provided by Beko plc. Beko House, 1 Greenhill Crescent, Watford, Hertfordshire. WD18 8QU.

Beko plc is registered in England and Wales with company registration number 02415578.

FLAVEL UK AND IRELAND BUILT-IN APPLIANCES GUARANTEE TERMS AND CONDITIONS

If you have purchased a built-in or integrated appliance in the United Kingdom or Northern Ireland, then the standard 12 month guarantee will be extended to 24 months, under the same terms and conditions as detailed in our Standard Guarantee Terms and Conditions. Built-in or integrated appliances purchased in the Republic of Ireland are excluded.

HOW TO OBTAIN SERVICE FOR YOUR APPLIANCE

Please keep your purchase receipt or other proof of purchase details in a safe place; you will need to have this documentation available should the product require attention under guarantee.

Please take a few moments to complete the details below, as you will need this information when you call us, or to use our online services. When you call us you may be required to input your serial number into your telephone keypad. For help please visit flavelappliances.com/support/model-finder

- The product model number is printed on the Operating Instruction Booklet / User guide
- The product model and serial number is printed on the Rating Label affixed to the appliance.
- The Retailer (Purchased from) and Date of purchase will be printed on your purchase receipt or other proof of purchase paperwork

Recording of these details alone will not count as proof of purchase. A valid proof of purchase is required for requesting service under guarantee.

Model number	Serial number	Purchased from	Date of purchase

For service under guarantee or for product advice please call our Contact centre

Before requesting service please check the troubleshooting guide in the Operating Instructions booklet, as a charge may be levied where no fault is found, and even though your product may still be under guarantee.

After arranging service the area around the product must be easily accessible to the Engineer, without the need for cabinets or furniture to be removed or moved.

It is your responsibility to ensure our Engineers have a clean and safe environment to carry out any repairs.

Please have your Model number and Serial number available when you call us, as you may be required to input your serial number into your telephone keypad during your call.

UK Mainland & Northern Ireland:

0333 207 9894

Landline or mobile calls to 0333 numbers cost no more than calls to geographic numbers 01 or 02, and are charged at the basic rate. Calls from landlines and mobiles are included in free call packages but please check with your telephone service provider for exact call charges.

Republic of Ireland:

01 691 0164

Service once the manufacturers guarantee has expired

If you have purchased an extended guarantee please refer to the instructions contained within the extended guarantee agreement document, otherwise please call us using the appropriate number above, where service can be obtained at a charge.

Should you experience any difficulty in obtaining service please call us on **0333 207 9894** or **01 691 0164**

Contact us though our website

Send us a secure message through our online contact us form. Please visit our website, click Contact Us and choose a product support topic from the list of options. Complete the required details and click send message.

Product registrations

For UK and Ireland registrations please visit flavelappliances.com/register.

Flavel, 1 Greenhill Crescent, Watford,
Hertfordshire, WD 18 8QU

Tel: 0845 6004916
Fax: 0845 6004925
www.leisurecp.co.uk

Printed in Romania

Part no: 4578333695
AA