

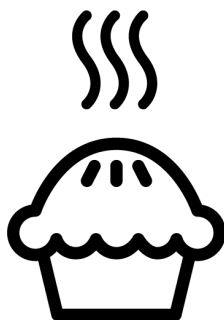

**Double Oven**  
User Manual



FDG6231CW  
FDG6231CK  
FDG6231CS

285380259/ EN/ R.AA/ 26/04/2024 19:14  
7734986404-7734986407-7734986415



## Welcome!

---

Dear Customer,

Thank you for choosing the Beko product. We want your product, manufactured with high quality and technology, to offer you the best efficiency. Therefore, carefully read this manual and any other documentation provided before using the product.

Keep in mind all the information and warnings stated in the user's manual. This way, you will protect yourself and your product against the dangers that may occur.

Keep the user's manual. If you give the product to someone else, give the manual with it. The warranty conditions, usage and troubleshooting methods for your product are provided in this manual.

### The symbols and their descriptions in the user's manual:



Hazard that may result in death or injury.



Important information or useful usage tips.



Read the user's manual.



Hot surface warning.

**NOTICE** Hazard that may result in material damage to the product or its environment.

**Arçelik A.Ş.**

Karaağaç caddesi No:2-6  
34445 Söğütözü/İstanbul/TURKEY

Made in TURKEY

## Table of Contents

<b>1 Safety Instructions.....</b>	<b>4</b>	<b>7 Using the Oven .....</b>	<b>38</b>
1.1 Intended Use.....	4	7.1 General Information on Using the Oven .....	38
1.2 Child, Vulnerable Person and Pet Safety .....	4	7.2 Using the bottom section of the oven.....	38
1.3 Electrical Safety .....	5	7.2.1 Settings .....	40
1.4 Safety While Working with Gas ....	7	7.3 Using the upper section of the oven.....	42
1.5 Transportation Safety .....	8	<b>8 General Information About Baking .....</b>	<b>43</b>
1.6 Installation Safety.....	9	8.1 General warnings about cooking with hob .....	43
1.7 Safety of Use.....	10	8.2 General Warnings About Baking in the Oven.....	43
1.8 Temperature Warnings.....	11	8.2.1 Pastries and oven food.....	44
1.9 Accessory Use .....	11	8.2.2 Meat, Fish and Poultry.....	45
1.10 Cooking Safety.....	11	8.2.3 Grill.....	46
1.11 Maintenance and Cleaning Safety .....	13	8.2.4 Test foods .....	47
<b>2 Environmental Instructions.....</b>	<b>13</b>	<b>9 Maintenance and Cleaning.....</b>	<b>47</b>
2.1 Waste Directive .....	13	9.1 General Cleaning Information.....	47
2.1.1 Compliance with the WEEE Directive and Disposing of the Waste Product.....	13	9.2 Cleaning Accessories.....	49
2.2 Package Information .....	14	9.3 Cleaning the hob.....	49
2.3 Recommendations for Energy Saving.....	14	9.4 Cleaning the Control Panel .....	50
<b>3 Your product .....</b>	<b>14</b>	9.5 Cleaning the inside of the oven (cooking area).....	50
3.1 Product Introduction .....	14	9.6 Cleaning The Upper Oven Door....	50
3.1.1 Cooking Section .....	15	9.7 Removing the Inner Glass of The Upper Oven Door .....	51
3.1.2 Hob section .....	15	9.8 Cleaning the Oven Lamp .....	52
3.2 Introduction of the oven control panel .....	15	<b>10 Troubleshooting .....</b>	<b>53</b>
3.3 Product Accessories .....	16		
3.4 Use of Product Accessories.....	17		
3.5 Technical Specifications .....	19		
<b>4 Installation .....</b>	<b>23</b>		
4.1 Right place for installation .....	23		
4.2 Electrical connection .....	25		
4.3 Gas connection.....	26		
4.4 Placing the product .....	30		
4.5 Gas Conversion.....	31		
<b>5 First Use.....</b>	<b>35</b>		
5.1 First Timer Setting.....	35		
5.2 Initial Cleaning .....	35		
<b>6 How to use the hob .....</b>	<b>36</b>		
6.1 General information on hob usage.....	36		
6.2 Operation of the hobs.....	37		



## 1 Safety Instructions

---

- This section includes the safety instructions necessary to prevent the risk of personal injury or material damage.
- If the product is handed over to someone else for personal use or second-hand use purposes, the user's manual, product labels and other relevant documents and parts should also be given.
- Our company shall not be held responsible for damages that may occur if these instructions are not observed.
- Failure to follow these instructions shall void any warranty.
- Always have the installation and repair works made by the manufacturer, the authorised service or a person that the importer company shall designate.
- Use original spare parts and accessories only.
- Do not repair or replace any component of the product unless it is clearly specified in the user's manual.
- Do not make technical modifications on the product.



### 1.1 Intended Use

- This product is designed to be used at home. It is not suitable for commercial use.
- Do not use the product in gardens, balconies or other outdoors. This product is intended to be used in households and in the staff kitchens of shops, offices and other working environments.
- **CAUTION:** This product should be used for cooking purposes only. It should not be used for different purposes, such as heating the room.
- The oven can be used to defrost, bake, fry and grill food.
- This product should not be used for plate heating, drying by hanging towels or clothes on the handle.



### 1.2 Child, Vulnerable Person and Pet Safety

- This product can be used by children 8 years of age and older, and people who are underdeveloped in physical, sensory or mental skills, or who have lack of experience and knowledge, as long as they are supervised or trained about the safe use and hazards of the product.

- Children should not play with the product. Cleaning and user maintenance should not be performed by children unless there is someone overseeing them.
- This product should not be used by people with limited physical, sensory or mental capacity (including children), unless they are kept under supervision or receive the necessary instructions.
- Children should be supervised to ensure that they do not play with the product.
- Electrical products and/or products with gas are dangerous for children and pets. Children and pets must not play with, climb on, or enter the product.
- Do not put objects that children may reach on the product.
- Turn the handle of the pots and pans to the side of the counter so that children cannot grab and burn.
- **CAUTION:** During use, the accessible surfaces of the product are hot. Keep children away from the product.
- Keep the packaging materials out of the reach of children. There is a hazard of injury and suffocation.
- When the door is open, do not put any heavy objects on it or allow children to sit on it. You may cause the oven to tip over or damage the door hinges.
- Before discarding worn out and useless products:
  1. Unplug the power plug and remove it from the socket.
  2. Cut off the power cable and disconnect it with the plug from the product.
  3. Take precautions to prevent children from entering the product.
  4. Do not allow children to play with product when it is in idle mode.



### 1.3 Electrical Safety

- Plug the product into a grounded outlet protected by a fuse that matches the current ratings indicated on the type label. Have the grounding installation made by a qualified electrician. Do not use the product without grounding in accordance with local / national regulations.
- The plug or the electrical connection of the appliance shall be in an easily accessible place. If this is not possible, there should be a mechanism (fuse, switch, key switch, etc.) on the electrical installation to

which the product is connected, in compliance with the electrical regulations and separating all poles from the network.

- Unplug the product or switch off the fuse before repair, maintenance and cleaning.
  - Plug the product into an outlet that meets the voltage and frequency values specified on the type label.
  - (If your product does not have a mains cable) only use the connecting cable described in the "Technical specifications" section.
  - Do not jam the power cable under and behind the product. Do not put a heavy object on the power cable. The power cable should not be bent, crushed, and come into contact with any heat source.
  - Make sure that the power cable is not jammed while putting the product to its place after assembly or cleaning.
  - The rear surface of the oven gets hot when it is in use. Gas connections and/or electrical cables must not touch the rear surface of the product. Otherwise it might get damaged.
  - Do not jam the electric cables into the oven door and do not pass them over hot surfaces.
- Otherwise, cable insulation may melt and cause fire as a result of short circuit.
- Use original cable only. Do not use cut or damaged cables.
  - Do not use an extension cord or multi-plug to operate your product.
  - Contact the authorized service centre or importer to use the approved adapter in cases where the use of a converter adapter (for plug type) is necessary.
  - Contact the importer or the authorized service centre if the length of the power line is inadequate.
  - Portable power sources or multiple plugs may overheat and catch fire. Keep multiple plugs and portable power sources away from the product.
  - If the power cable is damaged, it must be replaced by the manufacturer, an authorized service or a person to be specified by the importer company in order to prevent possible dangers.
  - **CAUTION:** Before replacing the oven lamp, be sure to disconnect the product from the mains supply to avoid the risk

of electric shock. Unplug the product or turn off the fuse from the fuse box.

If your product has a power cable and plug:

- Never put the product plug into a broken, loose, or out-of-socket plug. Make sure the plug is fully inserted into the socket. Otherwise the connections may overheat and cause a fire.
- Avoid inserting the device into plugs that are greasy, unclean, or potentially exposed to water (such as those near a worktop where water may escape). Otherwise there is a risk of short circuit and electrocution.
- Never touch the plug with wet hands!
- Pull the plug out of the socket using the plug's body rather than the cord itself.

#### **1.4 Safety While Working with Gas**

- **CAUTION:** The use of gas cooking products causes the formation of substances released as a result of heat, humidity and combustion in the room. Make sure that the kitchen is well ventilated, especially when using the product: Keep the natural ventilation

holes open or install a mechanical ventilation device (mechanical extractor / hood).

Intensive use of the product for a long time may require additional ventilation: For example, opening a window or more effective ventilation, raising the level of the mechanical ventilation device, if any, etc.

- This product should be used in a room that has a properly adjusted and functioning carbon monoxide sensor. Make sure that the carbon monoxide sensor is working properly and frequently service the sensor. The carbon monoxide sensor should be placed no more than 2 meters from the product.
- The setting conditions for this device is specified on the label (or on the data plate)
- Proper combustion is required in gas cooking products. In case of incomplete combustion, carbon monoxide (CO) might develop. Carbon monoxide is a colourless, odourless and very toxic gas, which has a lethal effect even in very small doses. You can understand that the gas is burning well if the flames are continuous and blue. If the

flames are wavy, cut and intensely yellow, the gas does not burn well.

- Gas cooking products and systems must be regularly checked for proper functioning. Regulator, hose and its clamp must be checked regularly and replaced within the periods recommended by its manufacturer or when necessary.
- Clean the gas hob zones regularly. Make sure that the gas burns properly after cleaning.
- Do not use pots / pans that exceed the dimensions given in the user manual. Using larger pans / pots than specified may cause carbon monoxide poisoning and overheating of nearby surfaces and control knobs. The use of smaller pans / pots may cause you to burn due to flames.
- Request information about gas emergency telephone numbers and safety measures in case of gas smell from your local gas provider.

 **What to do when you smell gas!**

- Do not use open flame or do not smoke. Do not use any electrical knobs (eg lamp knob or doorbell). Do not use fixed or mobile phones.

- Open the doors and windows.
- Turn off all valves on gas cooking products and gas meter at the main control valve, unless it's in a confined space or cellar.
- Check all tubes and connections for tightness. If you still smell gas, leave the house.
- Warn the neighbors.
- Call the fire-brigade. Use a phone outside the house.
- Call the authorized service and your gas distribution company.

## **1.5 Transportation Safety**

- Before transporting the product, disconnect the product from the mains and disconnect the gas connections.
- The product is heavy, carry the product with at least two people.
- Do not use the door and / or handle to transport or move the product.
- Do not place items on the appliance. Carry the appliance vertically.
- When you need to transport the product, wrap it with bubble wrap packaging material or thick cardboard and tape



it tightly. Secure the moving parts of the product firmly to prevent damage.

- Before the product is installed, check the product for any damage after transport. Contact the importer or the authorized service centre if damaged.

## 1.6 Installation Safety

- Before beginning the installation, de-energize the power line to which the product will be connected by turning off the fuse.
- Always wear protective gloves during transport and installation. Otherwise there is a risk of injury from sharp edges!
- Before the product is installed, check the product for any damage. Do not have it installed if the product is damaged.
- Never place the product on a carpet-covered floor. Product Otherwise, lack of airflow beneath the product will cause electrical parts to overheat. This will cause problems with your product.
- The product should be placed directly on a clean, flat and hard surface. It should not be placed on a plinth or bed plate. Products must not be placed on cardboard or plastic plates.
- Direct sunlight and heat sources, such as electric or gas heaters, must not be present in the area where the product is installed.
- Keep the surroundings of all ventilation ducts of the product open.
- Do not install the product near a window. There is a risk that the hob flame will ignite curtains and flammable materials around the hob. When you open the window, hot cookware may tip over.
- To avoid overheating, product installation should not be carried out behind decorative covers.
- In cases where a gas hose/ pipe or plastic water pipe is situated behind the designated installation area for the product, it is imperative to guarantee that there is no contact between the product and these utility lines. Otherwise the hose/pipe may be crushed.
- If there is a socket behind the place where the product will be installed, it must be ensured that the product does

not come into contact with the socket nor with the plug plugged into the socket.

- There should be no gas hose, plastic water pipe and socket on the back or side wall of the place where the product will be installed. Otherwise, they may be deformed by the heat effect when the hob is operated and may create a safety risk.
- Please cut off the gas supply before starting any work on gas installation. There is an explosion hazard.
- The connection of the product to the gas distribution system can only be made by an authorized and qualified person. There is an explosion or poisoning hazard due to repairs by non-professional people.
- The gas hose must be connected in such a way that it does not touch the moving parts in the area where it is placed and does not get caught when the moving parts move (eg drawer). In addition, the gas hose should not be placed in spaces where there is a possibility of jamming.
- The gas hose must not be crushed, folded, jammed or touch hot parts of the product and cookware on the product.

There is an explosion hazard due to damage to the gas hose.

- Make sure to check for gas leakage after the gas connection of your product is made. Make sure there are no gas leaks. Do not use the product if there is a gas leak.

### **1.7 Safety of Use**

- Ensure that the appliance is switched off after every use.
- If you will not use the product for a long time, unplug it or turn off the power from the fuse box. Shut off the main gas tap.
- Don't use the product if it breaks down or gets damaged while being used. Disconnect the product from the electricity. Contact the importer or the authorized service centre.
- Do not use the product if the front door glass is removed or cracked. Otherwise there is a risk of injury and environmental damage.
- Do not step on the appliance for any reason.
- Never use the product when your judgement or coordination is impaired by the use of alcohol and/or drugs.

- Flammable objects must not be kept in and around the cooking area. Otherwise, these may lead to fire.
- The oven handle is not a towel dryer. When using the product, do not hang towels, gloves or similar textiles on the handle.
- The hinges of the product door move when opening and closing the door and might jam. When opening / closing the door, do not hold the part with the hinges.
- This product is not suitable for use with a remote control or an external clock.
- Keep your distance when opening the oven door during or at the end of cooking. The steam may burn your hand, face and/or eyes.
- During operation the product is hot. Care should be taken to avoid touching hot parts, inside of the oven and heating elements.
- Always wear heat-resistant oven gloves when handling the product.
- **CAUTION:** Danger of fire: Do not store items on the cooking surfaces.

## 1.8 Temperature Warnings

- **CAUTION:** When the product is in use, the product and its accessible parts will be hot. Care should be taken to avoid touching the product and heating elements. Children under 8 years of age should be kept away from the product unless constantly supervised.
- Do not place flammable / explosive materials near the product, as the surfaces will be hot while it is operating.

## 1.9 Accessory Use

- It is important that the wire grill and tray are placed properly on the wire shelves. For detailed information, refer to the section "**Usage of accessories**".
- Close the oven door after pushing the accessories completely into the cooking space, otherwise they may hit the door glass and damage it.

## 1.10 Cooking Safety

- **CAUTION:** The cooking process must be observed. Short-term cooking processes must be constantly observed.

- **CAUTION:** In solid or liquid oil cooking, it is dangerous to leave the hob unattended, which may cause a fire. NEVER try to extinguish the fire with water; disconnect the product from the mains, and then cover the flames with a cover or fire cloth (etc.).
- Be careful when using alcoholic drinks in your dishes. Alcohol evaporates at high temperatures and may cause fire since it can ignite when it comes into contact with hot surfaces.
- Food residues in the cooking area., such as oil, can ignite. Clean these residues before cooking.
- Food Poisoning Hazard: Do not let food sit in oven for more than 1 hour before or after cooking. Otherwise it may cause food poisoning or diseases.
- Do not heat closed tins and glass jars in the oven. The pressure that would build-up in the tin/jar may cause it to burst.
- Do not place baking trays, dishes or aluminium foil directly onto the bottom of the oven. The accumulated heat might damage the bottom of the oven.

Be mindful of the following precautions when using greasy parchment paper or similar materials:

- Place the greaseproof paper in a cookware or on the oven accessory (tray, wire grill, etc.) with food and place it in the preheated oven.
- To prevent the risk of touching the oven heating elements and obstructing the flow of hot air, remove any excess parts of greaseproof paper that hang from accessories or containers. Do not use greaseproof paper at oven temperatures higher than the maximum usage temperature specified by the manufacturer. Never place greaseproof paper on the oven base.
- Do not place it on top of accessories during preheating.
- Always press down with a plate or similar object to prevent the material from flying around due to the air circulation inside the oven.
- Only cover the necessary surface inside the tray.
- After each use, the tray should be cleaned, and any greaseproof paper or similar materials used in the tray should be replaced. Otherwise,

liquids dripping onto the tray can cause smoking or even ignite flames.

- An air flow is generated when the product lid is opened. Greaseproof paper can come into contact with heating elements and ignite.
- When using a grilling rack for frying, a tray should be placed on the lower rack. Otherwise, the food oil and other components that drip onto the oven bottom can create heavy smoke and lead to flames.
- Food not suitable for grilling carries a fire hazard. Grill only food that is suitable for heavy grill fire. Do not place the food too far in the back of the grill. This is the hottest area and fatty foods may catch fire.
- Place the cookware in the center of the hob zone. Note that the fire in the hob zone

with the cookware does not overflow to the side surface of the cookware.



## 1.11 Maintenance and Cleaning Safety

- Wait for the product to cool before cleaning the product. Hot surfaces may cause burns!
- Never wash the product by spraying or pouring water on it! There is the risk of electric shock!
- Do not use steam cleaners to clean the product as this may cause an electric shock.
- Do not use harsh abrasive cleaners, metal scrapers, scouring pads, dish washing wire or bleach to clean the oven front door glass and oven top door glass (if equipped). These materials can cause glass surfaces to be scratched and broken.

## 2 Environmental Instructions

### 2.1 Waste Directive

#### 2.1.1 Compliance with the WEEE Directive and Disposing of the Waste Product

This product complies with EU WEEE Directive (2012/19/EU). This product bears a classification symbol for waste electrical and electronic equipment (WEEE).



This product has been manufactured with high quality parts and materials which can be reused and are suitable for recycling. Therefore, do not dispose of the waste product with normal domestic and other wastes at the end of its service life. Take it to a collection point for the recycling of electrical and electronic equipment. You can ask your local administration about these collection

points. Disposing of the appliance properly helps prevent negative consequences for the environment and human health.

---

### **Compliance with RoHS Directive:**

The product you have purchased complies with EU RoHS Directive (2011/65/EU). It does not contain harmful and prohibited materials specified in the Directive.

## **2.2 Package Information**

Packaging materials of the product are manufactured from recyclable materials in accordance with our National Environment Regulations. Do not dispose of the packaging waste with the household or other wastes, take it to the packaging material collection points designated by the local authorities.

## **2.3 Recommendations for Energy Saving**

According to EU 66/2014, information on energy efficiency can be found on the product receipt supplied with the product.

# **3 Your product**

---

In this section, you can find the overview and basic uses of the product's control panel. There may be differences in images and some features depending on the type of product.

The following suggestions will help you use your product in an ecological and energy-efficient way:

- Defrost frozen food before baking.
- In the oven, use dark or enamelled containers that transmit heat better.
- If specified in the recipe or user's manual, always preheat. Do not open the oven door frequently during baking.
- Turn off the product 5 to 10 minutes before the end time of baking in prolonged bakings. You can save up to 20% electricity by using residual heat.
- Try to cook more than one dish at a time in the oven. You may cook at the same time by placing two cookers on the wire rack. In addition, if you cook your meals one after the other, it will save energy because the oven will not lose its heat.
- Use pots / pans with a size and lid suitable for the hob zone. Always choose the right size pot for your meals. More than necessary energy is needed for containers of the wrong size.
- Keep hob baking areas and pot bases clean. Dirt reduces the heat transfer between the baking area and the pot base.

## **3.1 Product Introduction**

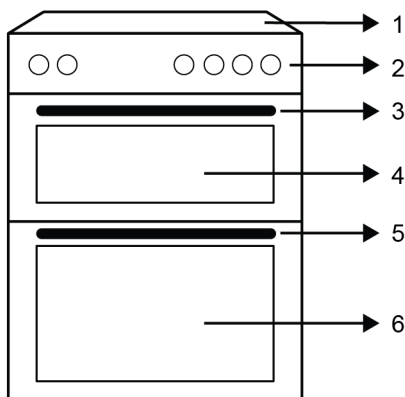

- 1 Hob section
- 2 Control panel
- 3 Handle (Upper cooking section)

- 4 Front door (Upper cooking section)
- 5 Handle (Bottom cooking section)
- 6 Front door (Bottom cooking section)

### 3.1.1 Cooking Section

#### Upper cooking section

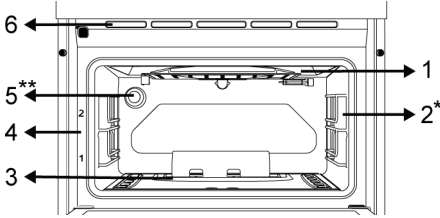

- 1 Gas grill burner
- 2 Wire shelves \*
- 3 Gas oven burner
- 4 Shelf positions
- 5 Lamp \*\*
- 6 Ventilation holes

\* Varies depending on the model. Your product may not be equipped with a wire rack. In the image, a product with wire rack is shown as an example.

\*\* Varies depending on the model. Your product may not be equipped with a lamp, or the type and location of the lamp may differ from the illustration.

#### Bottom cooking section

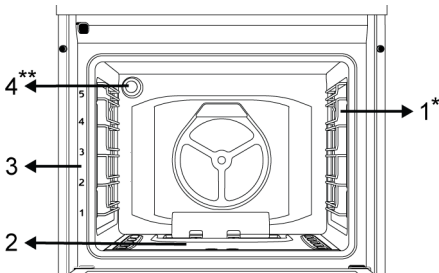

- 1 Wire shelves \*

- 2 Gas oven burner
- 3 Shelf positions
- 4 Lamp \*\*

\* Varies depending on the model. Your product may not be equipped with a wire rack. In the image, a product with wire rack is shown as an example.

\*\* Varies depending on the model. Your product may not be equipped with a lamp, or the type and location of the lamp may differ from the illustration.

### 3.1.2 Hob section

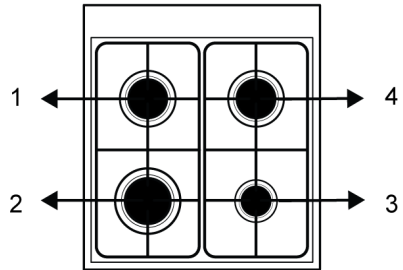

- 1 Rear left - Normal burner
- 2 Front left - Rapid burner
- 3 Front right - Auxiliary burner
- 4 Rear right - Normal burner

### 3.2 Introduction of the oven control panel

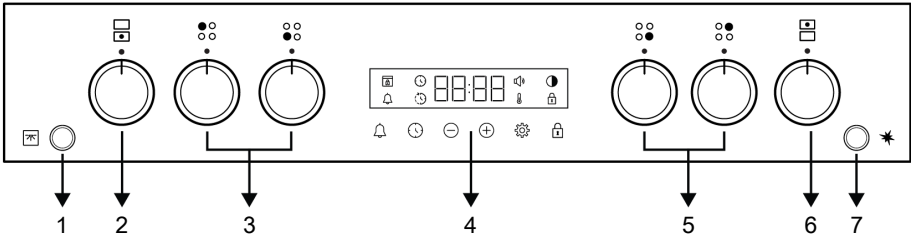

1 Lamp button

2 Oven control knob - Bottom cooking section

3 Hob control knobs

4 Timer

5 Hob control knobs

6 Oven control knob - Upper cooking section

7 Ignition button

### Lamp button

You may turn the lamp of your oven on and off with the lamp button. The lamp and the lamp button do not operate in case of a power interruption.

### Ignition button

It is used for igniting your oven. In case of power failure, the ignition button will not operate.

You may also ignite your hob zones with this button.

### Oven control knobs

The bottom and upper cooking sections of your oven are controlled by separate oven control knobs. These knobs are indicated on the control panel.

### Timer (Oven control unit)

The lower section of your oven is controlled with the timer. For detailed information, see the "Using the Oven" section.

### Hob control knobs

You can control your oven's hob with the hob control knobs. Each hob control knob controls the corresponding burner. You can understand it from the symbols on the control panel.

## 3.3 Product Accessories

There are various accessories in your product. In this section, the description of the accessories and the descriptions of the correct usage are available. Depending on the product model, the supplied accessory varies. All accessories described in the user's manual may not be available in your product.



The trays inside your appliance may be deformed with the effect of the heat. This has no effect on the functionality. Deformation disappears when the tray is cooled.

### Small tray

It is used for small portions. This oven tray is placed on top of the wire grill.

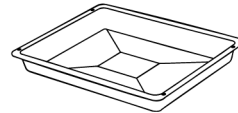

### Wire grill

It is used for frying or placing the food to be baked, fried and stewed on the desired shelf.



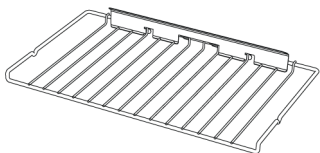

### Wire grill in tray

By placing it in the tray (if provided), it is ensured that the oils flowing while grilling are collected in the tray and thus the contamination of the oven is prevented.

Wire grill in tray is not suitable for use in deep tray.

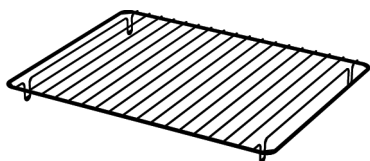

## 3.4 Use of Product Accessories

### Cooking shelves

There are 5 levels of shelf position in the bottom cooking section, 2 levels of shelf position in the upper cooking section. You can also see the order of the shelves in the numbers on the front frame of the oven.

#### On models with wire shelves :

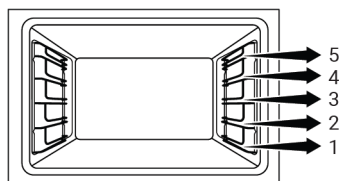
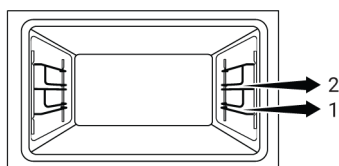

#### On models without wire shelves :

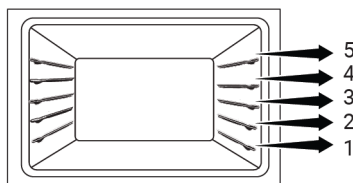
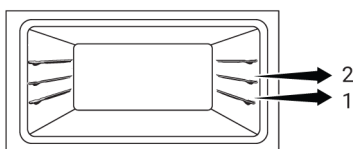

### Placing the wire grill on the cooking shelves

#### On models with wire shelves :

It is crucial to place the wire grill on the wire side shelves properly. While placing the wire grill on the desired shelf, the open section must be on the front. For better cooking, the wire grill must be secured on the wire shelf's stopping point. It must not pass over the stopping point to contact with the rear wall of the oven.

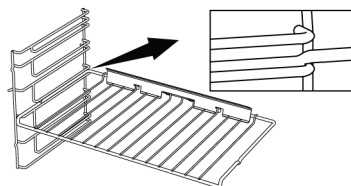

#### On models without wire shelves :

It is crucial to place the wire grill on the side shelves properly. The wire grill has one direction when placing it on the shelf. While placing the wire grill on the desired shelf, the open section must be on the front.

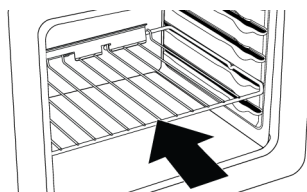

### Stopping function of the wire grill

There is a stopping function to prevent the wire grill from tipping out of the wire shelf. With this function, you can easily and safely take out your food. While removing the wire grill, you can pull it forward until it reaches the stopping point. You must pass over this point to remove it completely.

**On models with wire shelves :**

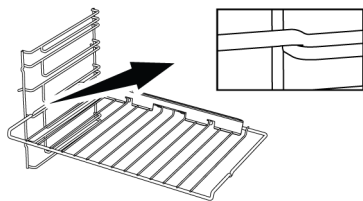

**On models without wire shelves :**

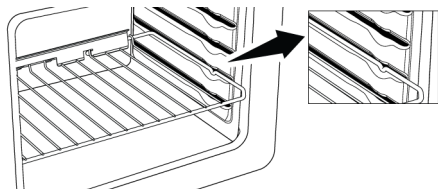

### 3.5 Technical Specifications

General specifications	
Product external dimensions (height/width/depth) (mm)	900-925 /600 /600
Voltage/Frequency	220-240 V ~ 50 Hz
Cable type and section used/suitable for use in the product	min. H05VV-FG 3 x 0,75 mm <sup>2</sup>
Fuse (min.)	3 A
Total power consumption (kW)	0.033

Total gas consumption (kW)	12,7 (923 g/h - G30)
Oven type (Upper cooking section)	Gas oven + Gas grill
Oven type (Bottom cooking section)	Gas oven

#### Cooking zones

Front left	Rapid burner
Power	2,9 kW (211 g/h – G30)

Front right	Auxiliary burner
Power	1,0 kW (73 g/h – G30)

Rear left	Normal burner
Power	2,0 kW (145 g/h – G30)

Rear right	Normal burner
Power	2,0 kW (145 g/h – G30)

<b>Gas type / pressure that the product is set</b>	
G20 20 mbar	

#### Category of gas product

Cat II 2H3+
-------------

#### Gas types / pressures to which the product can be converted:

G30/G31 28-30/37 mbar
-----------------------

Basics: Information on the energy label of electrical ovens is given in accordance with the EN 60350-1 / IEC 60350-1 standard. Those values are determined under standard load with bottom-top heater or fan assisted heating (if any) functions.

Energy efficiency class is determined in accordance with the following prioritization depending on whether the relevant functions exist on the product or not: 1-Eco fan heating , 2-Fan Heating , 3-Fan assisted low grill , 4-Top and bottom heating.

 Technical specifications may be changed without prior notice to improve the quality of the product.

 Figures in this manual are schematic and may not exactly match your product.



Values stated on the product labels or in the documentation accompanying it are obtained in laboratory conditions in accordance with relevant standards. Depending on operational and environmental conditions of the product, these values may vary.

### Country gas categories/types/pressure

You can find the gas type, pressure and gas category that can be used for the country where the product will be installed in the table below.

COUNTRY CODES	CATEGORY		GAS TYPE AND PRESSURE			
FR	Cat II	2E+3+	G20,20 mbar	G25,25 mbar	G30,28 30 mbar	G31,37 mbar
BE	Cat II	2E+3+	G20,20 mbar	G25,25 mbar	G30,28 30 mbar	G31,37 mbar
RU	Cat II	2H3B/P	G20,20 mbar	G30,30 mbar	G20,13 mbar	G20,10 mbar
CZ	Cat II	2H3+	G20,20 mbar	G30,28 30 mbar	G31,37 mbar	
NL	Cat II	2E(43.46 -45.3 MJ/m3 (0°C))3B/P	G25.3,25 mbar	G20,20 mbar	G30,30 mbar	
	Cat II	2L3B/P	G25,25 mbar	G20,20 mbar	G30,30 mbar	
GB	Cat II	2H3+	G20,20 mbar	G30,28 30 mbar	G31,37 mbar	
IE	Cat II	2H3+	G20,20 mbar	G30,28 30 mbar	G31,37 mbar	
ES	Cat II	2H3+	G20,20 mbar	G30,28 30 mbar	G31,37 mbar	
PT	Cat II	2H3+	G20,20 mbar	G30,28 30 mbar	G31,37 mbar	
CH	Cat II	2H3+	G20,20 mbar	G30,28 30 mbar	G31,37 mbar	
IT	Cat II	2H3+	G20,20 mbar	G30,28 30 mbar	G31,37 mbar	
SK	Cat II	2H3+	G20,20 mbar	G30,28 30 mbar	G31,37 mbar	
CY	Cat II	2H3+	G20,20 mbar	G30,28 30 mbar	G31,37 mbar	
SI	Cat II	2H3+	G20,20 mbar	G30,28 30 mbar	G31,37 mbar	
GR	Cat II	2H3+	G20,20 mbar	G30,28 30 mbar	G31,37 mbar	
PL	Cat II	2ELS3B/P	G20,20 mbar	G2.350,13 mbar	G30,37 mbar	
	Cat II	2E3P(B/P)	G20,20 mbar	G30,37 mbar		
DE	Cat II	2E3B/P	G20,20 mbar	G30,50 mbar		
AT	Cat II	2H3B/P	G20,20 mbar	G30,50 mbar		
SE	Cat II	2H3B/P	G20,20 mbar	G30,30 mbar		
LT	Cat II	2H3B/P	G20,20 mbar	G30,30 mbar		
NO	Cat II	2H3B/P	G20,20 mbar	G30,30 mbar		

COUNTRY CODES	CATEGORY		GAS TYPE AND PRESSURE			
			G20,20 mbar	G30,30 mbar		
MK	Cat II	2H3B/P	G20,20 mbar	G30,30 mbar		
XK	Cat II	2H3B/P	G20,20 mbar	G30,30 mbar		
RS	Cat II	2H3B/P	G20,20 mbar	G30,30 mbar		
RO	Cat II	2H3B/P	G20,20 mbar	G30,30 mbar		
DK	Cat II	2H3B/P	G20,20 mbar	G30,30 mbar		
EE	Cat II	2H3B/P	G20,20 mbar	G30,30 mbar		
MA	Cat II	2H3B/P	G20,20 mbar	G30,30 mbar		
FI	Cat II	2H3B/P	G20,20 mbar	G30,30 mbar		
HR	Cat II	2H3B/P	G20,20 mbar	G30,30 mbar		
TR	Cat II	2H3B/P	G20,20 mbar	G30,30 mbar		
MT	Cat I	3B/P	G30,30 mbar			
IS	Cat I	2H	G20,20 mbar			
LV	Cat I	2H	G20,20 mbar			
LU	Cat I	2E	G20,20 mbar			
BG	Cat I	2H	G20,20 mbar			
	Cat I	3B/P	G30,30 mbar			
HU	Cat I	2H	G20,25 mbar			
	Cat I	3B/P	G30,30 mbar			

### Injector Table

The table below gives injector values for all gas types of combustibles for gas conversion. You can reach your injector values by looking at the technical table for the gas types you can convert according to your combustibles and country. Injectors may not be supplied with your product. You can obtain it from authorized services or from the place where you purchased the product.

Cooking zones									
Power	G20,20 mbar	G30,28 30 mbar	G20,10 mbar	G20,13 mbar	G20,25 mbar	G25.3,25 mbar	G2.350,13 mbar	G30,37 mbar	G30,50 mbar
	G25,25 mbar	G31,37 mbar							
1 kW	72	50	90	84	68	80	95	47	43
2 kW	103	72	125	116	97	110	131	66	60
2,9 kW	115	87	155	145	108	130	165	80	75

Gas oven (Upper cooking section)									
Power	G20,20 mbar	G30,28 30 mbar	G20,10 mbar	G20,13 mbar	G20,25 mbar	G25.3,25 mbar	G2.350,13 mbar	G30,37 mbar	G30,50 mbar
	G25,25 mbar	G31,37 mbar							
2,1 kW	105	71	-	-	-	-	-	-	-

<b>Gas grill (Upper cooking section)</b>									
Power	G20,20 mbar G25,25 mbar	G30,28 30 mbar G31,37 mbar	G20,10 mbar	G20,13 mbar	G20,25 mbar	G25.3,25 mbar	G2.350,13 mbar	G30,37 mbar	G30,50 mbar
2,3 kW	110	75	-	-	-	-	-	-	-

<b>Gas oven (Bottom cooking section)</b>									
Power	G20,20 mbar G25,25 mbar	G30,28 30 mbar G31,37 mbar	G20,10 mbar	G20,13 mbar	G20,25 mbar	G25.3,25 mbar	G2.350,13 mbar	G30,37 mbar	G30,50 mbar
2,5 kW	115	78	-	-	-	-	-	-	-

## 4 Installation

### **!** General warnings

- Refer to the nearest Authorised Service Agent for installation of the product. Make sure that the electric and gas installations are in place before calling the Authorised Service Agent to have the product ready for operation. If not, call a qualified electrician and fitter to have the required arrangements made. The manufacturer shall not be held responsible for damages arising from procedures carried out by unauthorized persons which may also void the warranty.
- It is customer's responsibility to prepare the location the product shall be placed on and also have power and/or gas utility prepared.
- The rules specified in local standards about electrical and/or gas installations (legal rules on installation) shall be followed during product installation./Paragraph
- Check for any damage on the appliance before the installation. Do not have it installed if the appliance is damaged. Damaged products cause risks for your safety.

### 4.1 Right place for installation

- Place the product on a hard surface because of the air ducts under the product. It must not be placed onto a base or a pedestal. The feet of the product should not dip on soft surfaces, e.g. carpet, etc.
- The kitchen floor must be able to carry the weight of the appliance plus the additional weight of cookware and bakeware and food.
- This product is a class 1 device according to EN 30-1-1 standard. It can be placed adjacent to the kitchen walls, kitchen furniture or any other product in any dimension from behind and one edge. The kitchen furniture or equipment on the other side may only be of the same size or smaller.

- It can be used with cabinets on either side but in order to have a minimum distance of 400mm above hotplate level allow a side clearance of 65mm between the appliance and any wall, partition or tall cupboard.

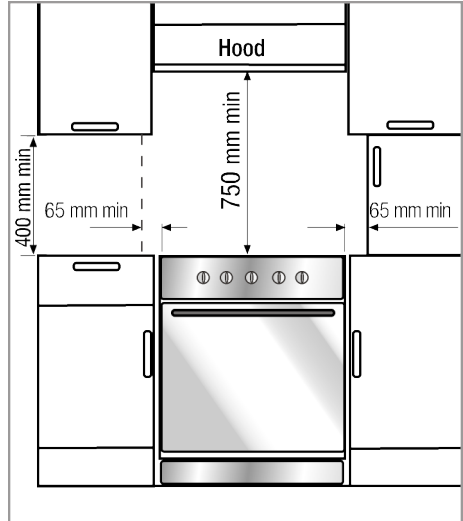

- It can also be used in a free standing position. Allow a minimum distance of 750 mm above the hob surface.
- If a cooker hood is to be installed above the cooker, refer to the instructions of the manufacturer of the cooker hood regarding installation height (min. 650 mm).
- Any kitchen furniture next to the appliance must be heat-resistant (100 °C min.).

### Safety chain

The appliance must be secured against overbalancing by using the supplied one safety chain on your oven.

### Warning - Risk of tipping!

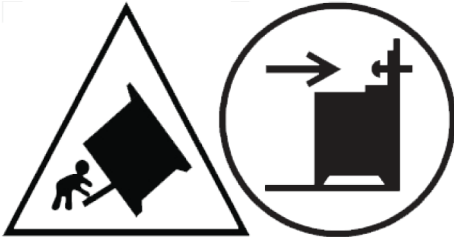

**Warning:** In order to prevent tipping of the appliance, this stabilizing means must be installed. Refer to the instructions for installation.

**If your product has 2 safety chains;** Fasten hook (1) by using a proper peg to the kitchen wall (6) and connect safety chain (3) to the hook via the locking mechanism (2).

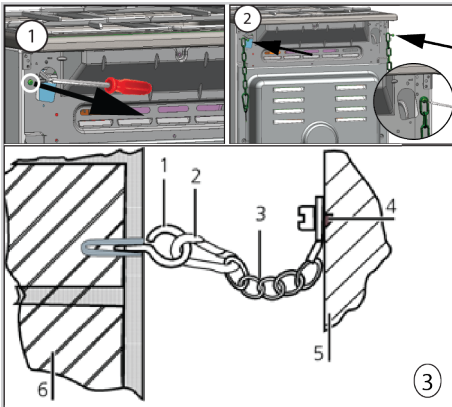

- 1 Hook
- 2 Locking mechanism
- 3 Safety chain/Name
- 4 Firmly fix chain to product rear
- 5 Rear of product
- 6 Kitchen wall

**If your product has 1 safety chains;** The appliance must be secured against overbalancing by using the supplied one safety chain on your oven. Follow below steps in the picture to secure the safety chain to your product.

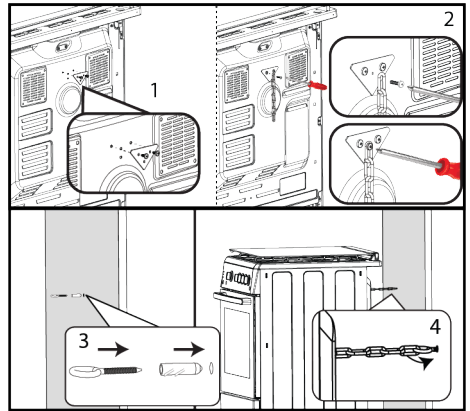

**i** Stability chain to be as short as practicable to avoid oven tilting forward and diagonal to avoid oven side tilting. Stability chain is designed for cookers without a bracket engagement slot.

### Room ventilation

All rooms require an openable window, or equivalent, and some rooms will require a permanent vent as well. The air for combustion is taken from the room air and the exhaust gases are emitted directly into the room. Good ventilation is essential for safe operation of your appliance.

### Rooms with doors and/or windows which open directly to the outer environment

The doors and/or windows that open directly to the outer environment must have a total ventilation opening of the dimensions specified in the table below which is based on the total gas power of the appliance (total gas power consumption of the appliance is shown in the technical specification table of this user manual). If the doors and/or windows do not have a total ventilation opening corresponding to the total gas consumption of the appliance as specified in the table below, then there must definitely be an additional fixed ventilation opening in the room to ensure that the total minimum ventilation requirements for the total gas consumption of the appliance is achieved. The fixed ventilation opening



can include openings for existing airbricks, extraction hood ducting opening dimension etc.

Total gas consumption (kW)	Min. ventilation opening (cm <sup>2</sup> )
0-2	100
2-3	120
3-4	175
4-6	300
6-8	400
8-10	500
10-11,5	600
11,5-13	700
13-15,5	800
15,5-17	900
17-19	1000
19-24	1250

### **Rooms that do not have openable doors and/or windows that open directly to the outer environment**

If the room where the appliance is installed does not have a door and/or a window that opens directly to the external environment, other products shall be sought that definitely provide a fixed non-adjustable and non-closable ventilation opening which meets the total minimum ventilation opening requirements for the total gas consumption of the appliance as indicated in the above table. Also the appropriate building regulations advise should be followed.

Where a room or internal space contains more than one gas appliance, additional ventilation area shall be provided on top of the requirement given in the table above. Size of additional ventilation area shall be appropriate to regulations of other gas appliances.

There should also be a minimum clearance of 10mm on the bottom edge of the door that opens to the inner environment in the room where the appliance is installed. You must ensure that items such as carpets and other floor coverings etc., do not affect the clearance when the door is closed.

The cooker may be located in a kitchen, kitchen/diner or a bed-sitting room, but not in a room containing a bath or a shower. The cooker must not be installed in a bed-sitting room of less than 20 m<sup>3</sup>. Do not install this appliance in a room below ground level unless it is open to ground level on at least one side.

## **4.2 Electrical connection**

### **General warnings**

- Disconnect the product from the electric connection before starting any work on the electrical installation. There is an electric shock hazard.
- Connect the product to a grounded outlet/line protected by a miniature circuit breaker of suitable capacity as stated in the "Technical specifications" table. Have the grounding installation made by a qualified electrician while using the product with or without a transformer. Our company shall not be liable for any damages that will arise due to using the product without a grounding installation in accordance with the local regulations.
- The product can only be connected to the mains electricity connection by an authorized and qualified person, and the warranty of the product starts only after correct installation. The manufacturer cannot be held responsible for any damages that may arise due to operations by unauthorized persons.
- The electric cable must not be crushed, folded, jammed or touch hot parts of the product. If the electric cable is damaged, it must be replaced by a qualified electrician. Otherwise there is an electric shock, short circuit or fire hazard!
- The mains supply data must correspond to the data specified on the type label of the product. The rating plate is either seen when the door or the lower cover of the appliance is opened or it is located at the rear wall of the appliance depending on the appliance type.

- Power cable plug must be within easy reach after installation (do not route it above the hob). Do not use extension or multi sockets in power connection.
- and must use the appropriate socket outlet/line and plug for oven. In case of the product's power limits are out of current carrying capability of plug and socket outlet/line, the product must be connected through fixed electrical installation directly without using plug and socket outlet/line.

**If your appliance has a cord and plug:**

Perform the electrical connection of your appliance by plugging it to a grounded socket.

The moulded plug on this appliance incorporates a 3 A fuse. Should the fuse need to be replaced an ASTA approved BS1362 fuse of the same rating must be used. Do not forget to refit the fuse cover. In the event of losing the fuse cover, the plug must not be used until a replacement fuse cover has been fitted. Colour of the replacement fuse cover must be the same colour as that visible on the pin face of the plug. Fuse covers are available from any good electrical store.

**Fitting a different plug**

As the colours of the wires in the mains lead of this appliance may not correspond with the coloured markings identifying the terminals on your plug, proceed as follows:

- Brown cable = L (Live)
- Blue cable = N (Neutral)
- Green/yellow cable must be connected to ground (E)  line.

With the alternative plugs a 3 A fuse must be fitted either in the plug or adaptor or in the main fuse box. If in doubt contact a qualified electrician.

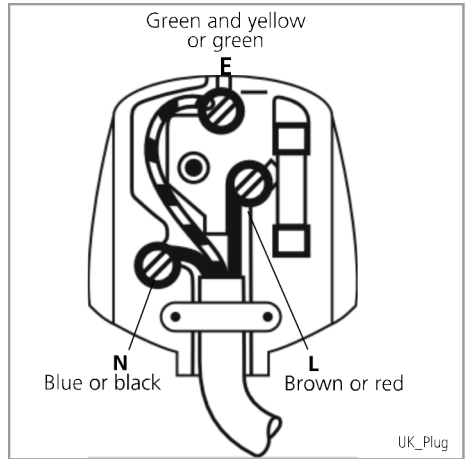

**4.3 Gas connection**

**⚠ General warnings**

- There is risk of explosion, fire and toxication could be occur if installation, repair or connection are made from unauthorised/unlicensed/ unqualified person or technician.
- Before placing the product, make sure that the local distribution conditions (gas type and pressure) and whether the product gas setting complies with these conditions. Gas adjustment conditions and values of the product are located on the labels (or type label).
- If your country code is not on the label, follow the local technical instructions for your country for gas connection and conversion.
- Product can be connected to gas supply system only by an authorised/licensed/ qualified person or technician.
- Manufacturer shall not be held responsible for damages arising from procedures carried out by unauthorised/unlicensed/ unqualified person or technician.
- Before starting any work on the gas installation, disconnect the gas supply. There is the risk of explosion!

- If you need to use your product later with a different type of gas, you must consult the authorised/licensed/ qualified person or technician for the related conversion procedure.
- Make sure that the gas connection is checked well for tightness after each use. The manufacturer cannot be held responsible for any damages that may arise due to gas leakage that may occur as a result of gas connection or conversion made by unauthorized/non-licensed persons.

### Risks of fire:

- If you do not make the connection according to the instructions below, there will be the risk of gas leakage and fire. Our company cannot be held responsible for damages resulting from this.
- Gas connection must be made by an authorised/licensed/ qualified person or technician only.
- Make sure that the gas hose to be used in the gas connection complies with the local gas standards.
- The flexible gas hose must be connected in a way that it does not contact the moving parts and hot surfaces (shown below figures) around it and is not trapped when the moving parts are travelling. (e.g. drawers). Besides, it should not be placed in spaces where it might get squeezed.
- Do not move the product whose gas connection is complete. If it is moved, there may be a risk of gas leakage.
- A spanner must be used for gas connection and conversion.
- A spanner must be used for gas connection.

### Choosing the gas connection side

- The gas hose should be connected by making wide-angle turns against the possibility of breaking and folding during the connection.
- The gas hose should not be crushed, folded, pinched, touched by sharp corners or come into contact with hot parts of

the product and cookware on the product. There is a risk of explosion due to damage to the gas hose!

- The gas hose should not come into contact with parts that can reach a temperature of 70 C above room temperature.

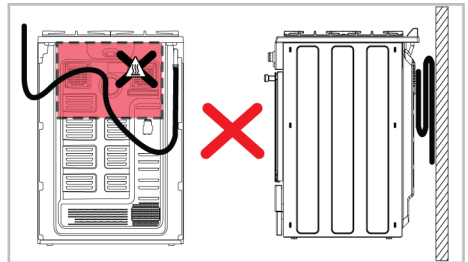
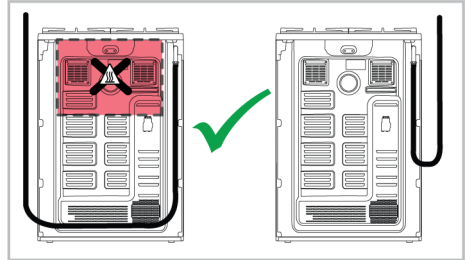

- Before gas connection, make sure that the gas main supply and the gas hose outlet of the product to be connected to the gas is on the same side.

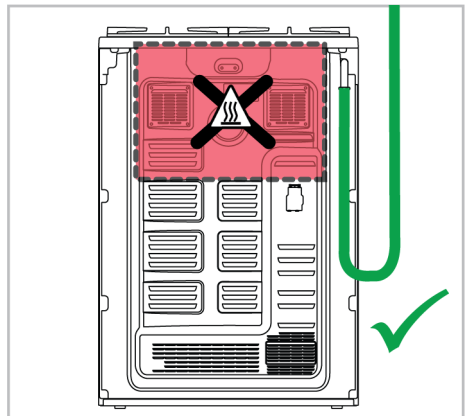

- If the gas hose outlet and the gas main supply do not face on the same side, make sure that the hose does not pass through the hot area when connecting it.

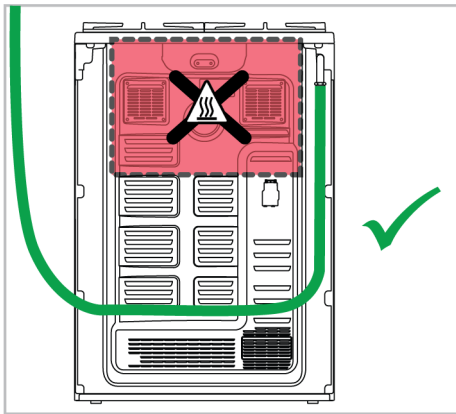
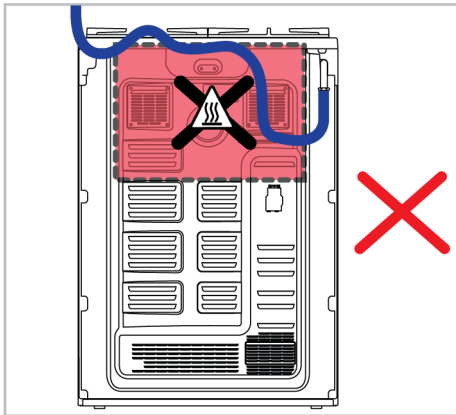
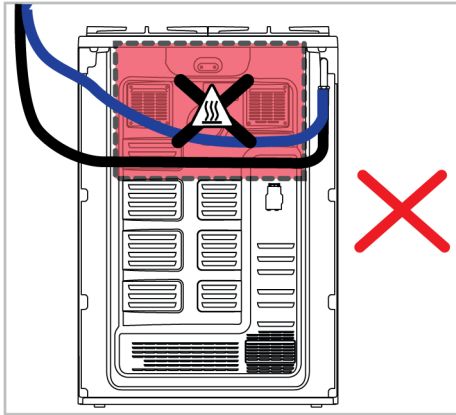

### Parts for Gas Connection

The parts and tools visuals, may be required for the gas connection are given below. Depending on the model, these parts may not be given with the product. The gas

connections parts to be used may vary according to the gas type and country regulations.

Leakage Seal :



Connection piece EN 10226 R1/2" :

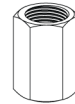

Connection piece for liquid gas (G30,G31) :

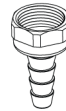

Gas outlet connection piece :

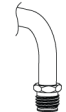

Blind plug :



### Making the gas connection - NG

- Natural gas installation must be prepared suitably for the assembly before installing the product. There must be a natural gas valve at the outlet of gas system to be connected to the product.
- Make sure that the natural gas valve is readily accessible.
- Connect your product to the natural gas system in your home with a flexible gas hose that complies with local standards.
- A new sealing gasket must be used while making the gas connection.
- The gas supply must be connected via a gas pipe or a safety gas hose with threaded fittings at both ends.

## EN 10226 R1/2" type connection

1. Place the new seal in the connection piece and make sure the seal is seated correctly.
2. While holding the gas connection outlet of the product fixed with a 22 spanner, connect the interconnection piece to the product gas outlet with a 24 spanner and tighten securely.

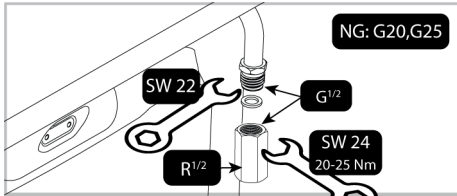

3. Insert the new sealing gasket into the safety gas hose/pipe. Make sure the gasket is seated correctly.
4. Connect the threaded part of the safety gas hose/pipe to the interconnector with the 24 mm spanner and tighten securely, holding the interconnector in place with the 24 mm spanner.

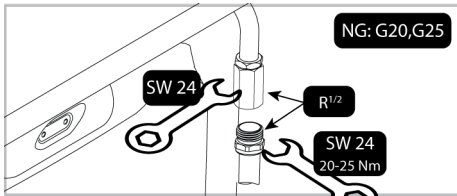

5. You must check for leakage of the connection part after connection.

## Making the gas connection - LPG

- Your product should be connected in a way that it will be close to the gas connection to prevent gas leakage.
- Before making your gas connection, provide a plastic gas hose and suitable mounting clamp. The inner diameter of the plastic gas hose must be 10 mm and the length should not be longer than 150 cm. The plastic hose must be leak-proof and inspectable.
- Gas appliances and systems must be regularly checked for proper functioning. Regulator, hose and its clamp must be

checked regularly and replaced within the periods recommended by its manufacturer or when necessary.

- A new sealing gasket must be used while making the gas connection.
- The gas connection must be made via a gas hose or a fixed connection.

## Connection with clamped (threadless) gas hose

1. Place the new seal in the connection piece for liquid gas and make sure the seal is seated correctly.
2. Secure the gas connection outlet of the product with a 22 mm spanner, connect the connecting piece to the gas outlet of the product with a 24 mm spanner and tighten securely.

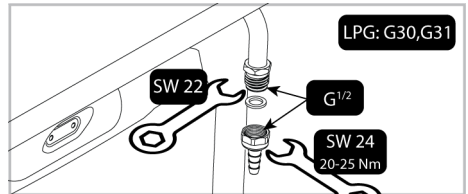

3. Fit the mounting clamp to one end of the gas hose. Soften the end of the gas hose to which you have attached the clamp by placing it in boiling water for one minute.
4. Insert the softened gas hose all the way into the connection piece. Tighten the clamp securely with a screwdriver.

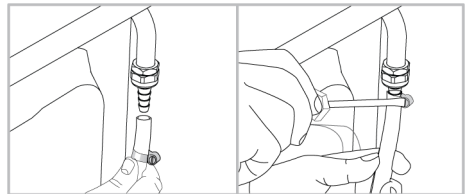

5. You must check for leakage of the connection part after connection.

## EN ISO 228 G1/2" type connection

1. Insert the new sealing gasket into the safety gas hose/pipe. Make sure the gasket is seated correctly.

- Secure the gas connection piece to the appliance with using a 22 mm spanner and place the connection piece into the connection piece using a 24 mm spanner.

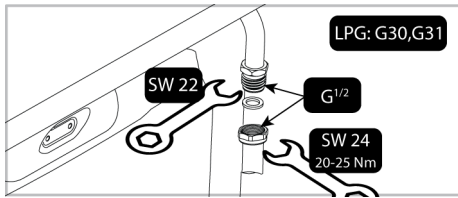

- You must check for leakage of the connection part after connection.

### EN 10226 R1/2" type connection

- Place the new seal in the connection piece and make sure the seal is seated correctly.
- While holding the gas connection outlet of the product fixed with a 22 spanner, connect the interconnection piece to the product gas outlet with a 24 spanner and tighten securely.

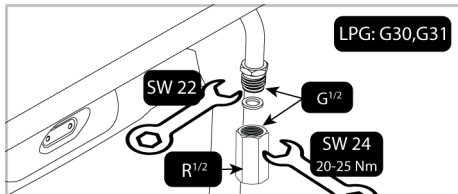

- Insert the new sealing gasket into the safety gas hose/pipe. Make sure the gasket is seated correctly.
- Connect the threaded part of the safety gas hose/pipe to the interconnector with the 24 mm spanner and tighten securely, holding the interconnector in place with the 24 mm spanner.

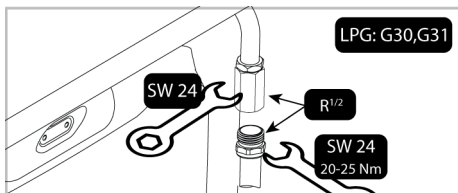

- You must check for leakage of the connection part after connection.

### Leakage check at the connection point

- Make sure that all knobs on the product are turned off. Make sure that the gas supply is open. Prepare soapy foam and apply it onto the connection point of the hose for gas leakage control.
- Soapy part will froth if there is a gas leakage. In this case, inspect the gas connection once again.
- Instead of soap, you can use commercially available sprays for gas leak check.
- If there is gas leak, shut off the gas supply and ventilate the room.
- Never use a match or lighter to make the gas leakage control.

### 4.4 Placing the product

- Push the product towards the kitchen wall.
- Secure the safety chain you have connected to the product to the wall.
- Adjust the feet of oven

#### Adjusting the feet of oven

Vibrations during use may cause cooking vessels to move. This dangerous situation can be avoided if the product is level and balanced.

For your own safety please ensure the product is level by adjusting the four feet at the bottom by turning left or right and align level with the work top.

#### Final check

- Reconnect the product to the mains.
- Check electrical functions.
- Open gas supply.
- Check whether the gas connections are securely attached and whether there are any leaks.
- Ignite burners and check appearance of the flame.



Flame must be blue and have a regular shape. If the flame is yellowish, check if the burner cap is seated securely or clean the burner.

## 4.5 Gas Conversion



### General warnings

- Before starting any work on the gas installation, disconnect the gas main supply. There is the risk of explosion!
- All gas injectors must be replaced and the burning adjustment of the gas taps must be made in reduced flow rate position in order to make the product suitable for use with another gas.
- After the gas type has been changed, the new gas type label on the spare bag must be applied onto the current label already on the backwall of product.
- The convertible gas type and gas categories of your product by country are given in the "Country gas categories/types/pressure" section. Check the table in this table for the types of gas you can convert in your local area. You cannot convert to unspecified gas types in this table.
- Spare injector suitable for the type of gas you wish to convert may not be supplied with product. You can obtain the injectors from the authorized service or from the place where you purchased the product.
- Injector values and gas types that should be used for burners are given at the end of the section. Make the connection of the gas type to be converted as described in the gas connection section.
- **Gas conversion must only be carried out by a Gas Safe registered installer or service agent.**

### Parts for Gas Conversion

The parts and tools visuals, may be required for the gas conversion are given below. Depending on the model, these parts may not be given with the product.

### Bypass nozzle:

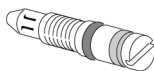

Burner injector:



### Exchange of injector for the burners

1. Turn all control knobs to off positions on the control panel.
2. Shut off the gas supply.
3. Remove the pan supports, the cap and head of the hob burners.
4. Remove the gas injectors by turning counter clockwise. (spanner 7)

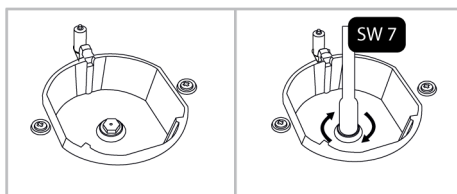

5. If your product has a wok combustor with a side-entry injector, remove the injector with a number 7 spanner.

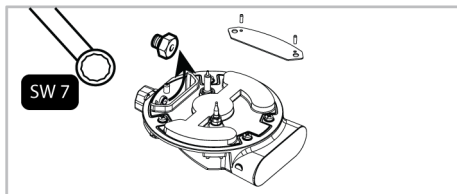

On some hob burners, the injector is covered with a metal piece. This metal cover must be removed for injector replacement.

6. Install the new gas injectors. (Tightening torque 4 Nm)
7. Check all connections in order to make sure that they are installed safely and securely.

**i** New injectors have their position marked on their packing or injector table on can be referred to.

8. You must check for leakage injectors after connection.

**i** Unless there is an abnormal condition, do not attempt to remove the gas burner taps. You must call an Authorised service agent or technician with licence if it is necessary to change the taps.

### Reduced gas flow rate setting for hob taps

1. Ignite the burner that is to be adjusted and turn the knob to the reduced position.
2. Remove the knob from the gas tap.
3. Use an appropriately sized screwdriver to adjust the flow rate adjustment screw.
4. For LPG (Butane - Propane) turn the screw clockwise. For the natural gas, you should turn the screw counter-clockwise once.
  - ⇒ The normal length of a straight flame in the reduced position should be 6-7 mm.
5. If the flame is higher than the desired position, turn the screw clockwise. If it is smaller turn anticlockwise.
6. For the last control, bring the burner both to high-flame and reduced positions and check whether the flame is on or off.
7. Depending on the type of gas tap used in your appliance the adjustment screw position may vary.

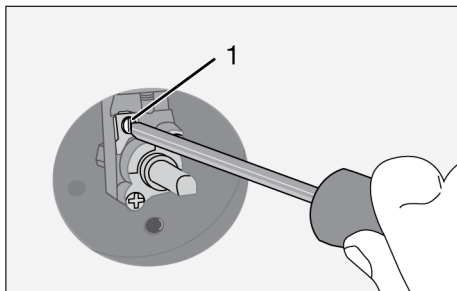

1 Flow rate adjustment screw

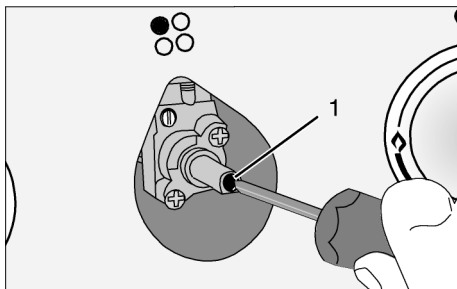

1 Flow rate adjustment screw

### Replacement of the grill injector

1. Switch off all control buttons on the control panel.
2. Shut gas supply.
3. Remove the screws securing the rear wall.

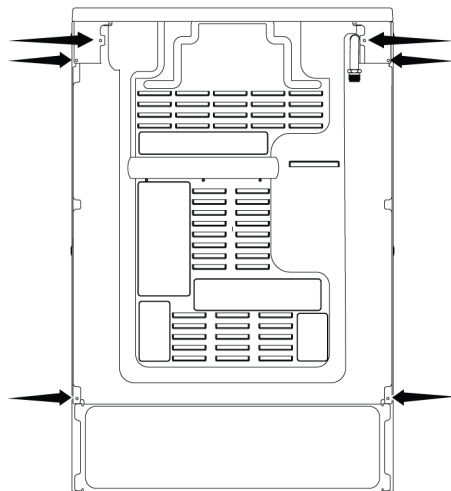



- After removing the rear wall you can access to the grill burner pipe and the grill injector holder.

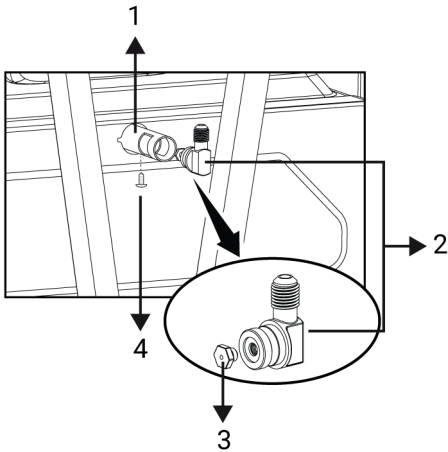

- Grill burner
- Injector holder
- Injector
- Screw

- Remove the securing screw of the grill injector holder.
- Remove the injector and replace with a suitable one, see the injector table.
- After replacing the injector, perform a leakage check.
- Install the injector holder to the grill burner pipe.
- Secure the injector holder with a screw.
- Assemble the rear wall.

### Exchange of injector for the burners

It is recommended to remove the top oven door disassemble oven door, to provide an ergonomic disassemble of the oven burner.

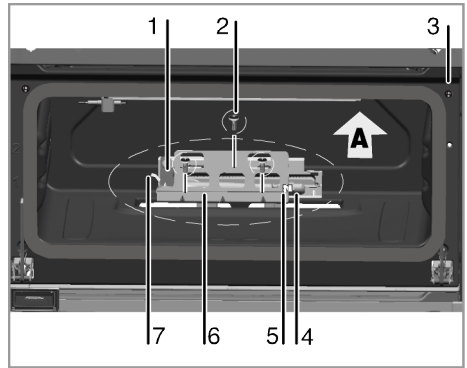

- Oven burner
- Screw (3 pieces)
- Cut-off valve
- Injector holder
- Injector
- Oven burner holder
- Clips

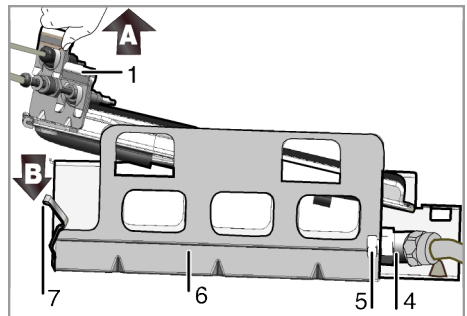

- Turn all control knobs to off positions on the control panel.
- Shut off the gas supply.
- Unscrew 3 screws (2) to remove oven burner (1) and oven burner holder (7).
- Gently pull up burner and holder in "A" direction- be careful with gas connection tube and thermocouple.
- Push the clips (7) in "B" direction to disassemble oven burner (1) and its holder(6).
- Unscrew the injector (5) and replace it with appropriate injector, see injector table.

7. Conduct the leakage control after replacing the injector.
8. Assemble the oven burner (1) to its holder (6) by pushing the burner on the clips (7) in "B" direction.
9. Mount the oven burner (1) and holder (6) as a group to the cavity by screwing 3 screws (2).

### Reduced flow adjustment for the gas oven

For the appropriate functioning of the oven re-checking the by-pass adjustment is extremely important. In order to provide maximum security to the user these operations have to be done with care.

1. Ignite the burner that is to be adjusted and turn the knob to the high flame position.
2. Close the oven door and wait for 10 to 15 minutes until the oven becomes ready for adjustment.
3. Take out the knob
4. After 15 minutes, adjust the oven to the lowest flame position.

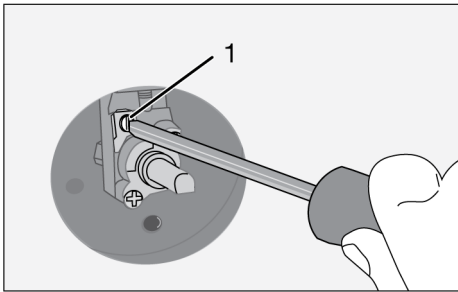

5. Set the flame length to 2 to 3 mm by means of the screw (1) on the oven tap. Turning in clockwise direction reduces the flame, turning counter-clockwise increases the flame.

**i** If gas flow rate of oven cannot be set with removing knob, please remove the needed oven parts (control panel, burner plate etc.) and then set the gas flow rate of oven.

**i** If the temperature of the oven increases excessively, turn off the oven and call the authorised service to have oven thermostat repaired.

### Leakage check at the injectors

Before carrying out the conversion on the product, ensure all control knobs are turned to off position. After the correct conversion of injectors, for each injectors should be gas leak checked.

1. Make sure that the gas supply to the product is on, still maintaining all control knobs turned to off position.
2. Each injector hole is blocked with a finger applying reasonable force to stop the gas leakage when corresponding control knob turned to on and it held at depressed position to allow gas reach the injector.

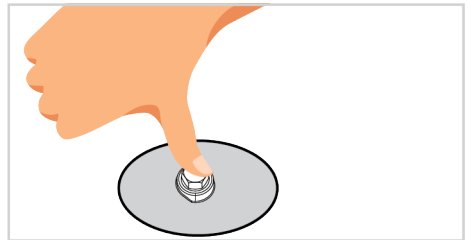

3. Apply prepared soapy water at the injector connection with a small brush, if there is leakage of gas at the injector connection the soapy water will begin to froth. In this case, tighten the injector with a reasonable force and repeat step 3 process once again.

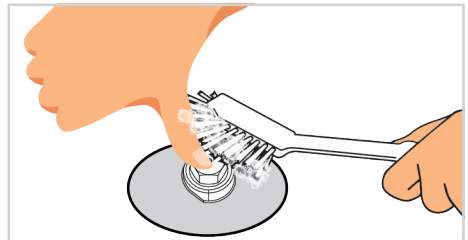

4. If the froth still persist you must turn off the gas apply to the product immediately and call an Authorised service agent or technician with licence. Do

not use the product until the authorized service has intervened in the product.

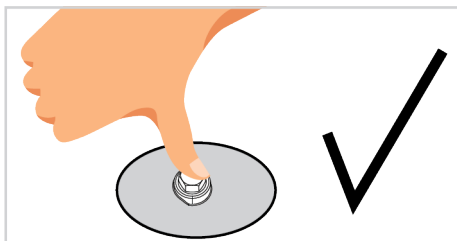
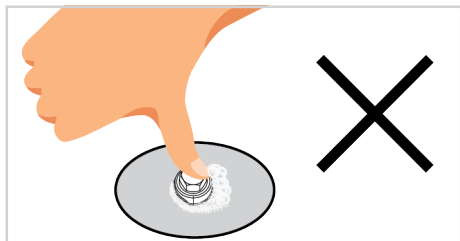

## 5 First Use

Before you start using your product, it is recommended to do the following stated in the following sections respectively.

### 5.1 First Timer Setting



Always set the time of day before using your oven. If you do not set it, you cannot cook in some oven models.

1. When the oven is first started, "12:00" and ⌚ symbol will flash on the display.
2. Set the time of day by touching the ⊕/⊖ keys.

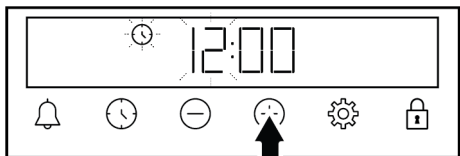

3. Touch ⌚ or ⚙️ key to activate the minutes field.

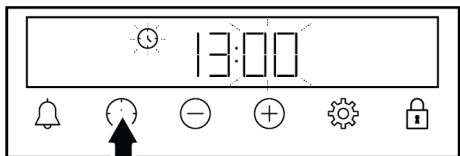

4. Touch the ⊕/⊖ keys to set the minute.

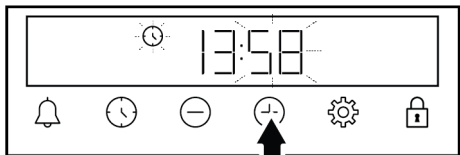

5. Confirm by touching the ⌚ or ⚙️ key.

⇒ The time of day is set and the ⌚ symbol disappears on the display.



If the first timer is not set, "12:00" and ⌚ symbol continue to flash and your oven will not start. For your oven to function, you must confirm the time of day by setting the time of day or touching the ⌚ key when it is at "12:00". You can change the time of day setting later as described in the "Settings" section.



In the event of a power outage, the time of day settings are cancelled. It should be set again.

### 5.2 Initial Cleaning

1. Remove all packaging materials.
2. Remove all accessories from the oven provided with the product.
3. Operate the product for 30 minutes and then, turn it off. This way, residues and layers that may have remained in the oven during production are burned and cleaned.
4. Wait for the oven to cool.
5. Wipe the surfaces of the product with a wet cloth or sponge and dry with a cloth.

### Before using the accessories:

Clean the accessories you remove from the oven with detergent water and a soft cleaning sponge.

**NOTICE:** Some detergents or cleaning agents may cause damage to the surface. Do not use abrasive detergents, cleaning powders, cleaning creams or sharp objects during cleaning.

## 6 How to use the hob

### 6.1 General information on hob usage

#### General warnings

- Place pots and pans in a manner so that the handles are not over the burners to prevent them from overheating.
- Do not use unbalanced and easily tilting pots/pans on the hob.

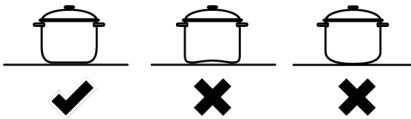

- Do not heat the pots/pans and pots empty. The pots and the appliance may be damaged.
- Do not ignite the burners without any pot or pots/pans on the respective burner.
- Always turn off the hob's burners after each use.
- You shall damage the appliance if you operate the hobs without any pot or pots/pans. Always turn off the hobs after each operation.

#### Recommended cooking pots/pans sizes

Hob burner type	Pot diameter - cm
Auxiliary burner	16 – 18
Normal burner	18 – 20
Rapid burner	20 - 22
Wok burner	22 - 24

Do not use pots/pans that exceed the above stated dimensions. Using larger pans / pots than specified may cause carbon monoxide poisoning and overheating of nearby surfaces and knobs. In addition, if the cooking surface of your product is glass, overheating will occur on this sur-

**NOTICE:** During the first use, smoke and odour may come up for several hours. This is normal and you just need good ventilation to remove it. Avoid directly inhaling the smoke and odours that form.

- Put a sufficient amount of food in pots and pans. Thus, you can prevent food from pouring forth out of the pots/pans and will not need to clean unnecessarily.
- Do not place the covers of pots and pans on burners/zones.
- Place the pots by centering them on the burners/zones. If you wish to place a pot on a different burner/zone, do not slide it towards the desired burner; rather, lift it first and then put it on the other burner.
- The size of the cooking pots/pans shall match the size of the flame. Set the gas flames so that they shall not protrude from the base of the pots/pans and place the pots/pans on pot holder by centering it. Do not use large pans/pots to cover more than one burner.

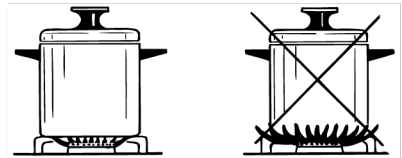

face and the product will be damaged. The use of smaller pans / pots may cause you to burn due to flames.

## 6.2 Operation of the hobs

### Gas burner control knob

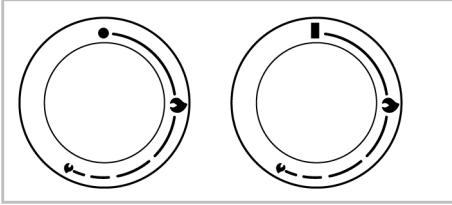

- Off position
- 🔥 Small flame: Lowest gas power
- 🔥 Large flame: Highest gas power

You can operate your hob with the hob control knobs. Each knob operates the respective burner. You may infer which burner it controls from the symbols on the control panel.

When turned off (top position), the burner is not fuelled with gas. After igniting the burner, you can cook by setting the gas levels on the knob. Set your desired cooking power by aligning the knob to the respective symbol.

### Igniting the gas burners

- ✓ The gas burners are ignited with the control knobs.
1. Press on the burner knob.
  2. While pressing on the knob, turn it counter clockwise to the large flame symbol.
  3. With the resulting spark, the gas is ignited.
  4. After the initial ignition, keep pressing on the knob for 3-5 seconds.

5. If the gas is not ignited after pressing on and releasing the knob, repeat the same process by pressing on the knob for 15 seconds.

**i** Release the button if the burner is not ignited within 15 seconds. Wait at least 1 minute before trying again. There is the risk of gas accumulation and explosion!

6. Adjust your desired power level.

### Turning off the gas burners

Bring the burner knob to off position (top).

**i** If the flames of the burner are extinguished inadvertently, turn off the burner control knob. Do not attempt to ignite the burner again for 1 minute at least.

### Gas shut-off safety mechanism

As a precaution against blow out due to overflows over the top burners, a safety mechanism starts to operate and shuts off the gas immediately.

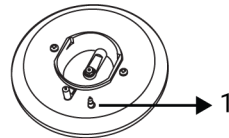

- 1 Gas shut off safety

To activate the gas shut-off safety mechanism, keep the control knob pressed for 3-5 seconds more after igniting the hob.

**i** Release the knob if the burner is not ignited within 15 seconds. Wait at least 1 minute before trying again. There is the risk of gas accumulation and explosion!

## 7 Using the Oven

### 7.1 General Information on Using the Oven

**Cooling fan ( It varies depending on the product model. It may not be available on your product. )**

Your product has a cooling fan. The cooling fan is activated automatically when necessary and cools both the front of the product and the furniture. It is automatically deactivated when the cooling process is finished. Hot air comes out over the oven door. Do not cover these ventilation openings with anything. Otherwise, the

oven may overheat. The cooling fan continues to operate during oven operation or after the oven is turned off (approximately 20-30 minutes). If you cook by programming the oven timer, at the end of the baking time, the cooling fan turns off with all functions. The cooling fan running time cannot be determined by the user. It turns on and off automatically. This is not an error.

#### Oven lighting

You can turn on the lighting in your oven by pushing the lamp button. Push the lamp button again to turn it off.

### 7.2 Using the bottom section of the oven

#### Oven control knob - Bottom cooking section

You can control your oven with the oven control knob. In the off position (top), no gas is supplied to the oven. After lighting the oven burner, you can cook by adjusting the gas levels on the knob.

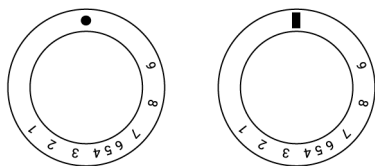

● ■ Off position

1-9 Oven gas levels

Gas level	Temperature (°C)
1	135
2	140
3	150
4	170
5	180
6	190
7	210
8	230
9	265

#### Using the gas oven

**i** Before you can use the oven, the time must be set. If the time is not set, oven can not be ignited with electricity.

**i** Product is equipped with a security valve. When the flame goes out, gas supply is cut automatically. Thus, gas accumulation is prevented.

#### Turning on the gas oven

- ✓ The gas oven is ignited with the ignition button.

1. Open oven door.
2. Keep gas oven control knob pressed and turn it **counterclockwise**.
3. Press ignition button and release it again.
4. Keep the gas oven control knob pressed for 3 to 5 seconds.
  - ⇒ Repeat the procedure until the released gas is ignited.
5. Keep the gas oven control knob pressed for another 3 to 5 seconds.

- Select the desired baking power/ gas mark.

### Turning off the gas oven

Turn gas oven control knob to off position (top).



Do not attempt to ignite the gas more that 15 seconds. If the burner is not ignited within 15 seconds, turn off the knob and wait for 1 minute. Ventilate the room before reattempting to ignite the burner. There is the risk of gas compression and explosion!

### General warnings for the oven control unit

- The maximum time that can be set for the baking process is 5 hours 59 minutes. In case of a power failure, the program is canceled. You will need to re-program.
- While making any adjustments, the relevant symbols flash on the display. A short time should be waited for the settings to be saved.
- If any cooking setting has been made, the time of day cannot be adjusted.
- If cooking time is set when cooking starts, the remaining time is displayed on the display.
- In cases where cooking time or cooking end time is set; you can cancel automatically by touching the ⌚ key for a long time.
- The control unit only controls the bottom cooking section. It has no effect on the upper cooking section.
- After igniting the oven, please wait at least three minutes before cooking for the first time.

### Timer

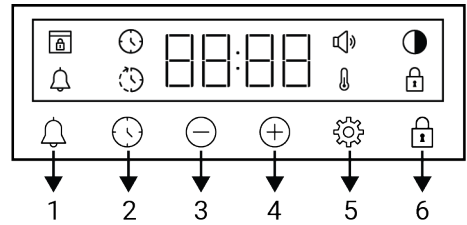

- Alarm key
- Time setting key
- Decrease key
- Increase key
- Settings key
- Key lock key

### Display symbols

- ⌚ : Baking time symbol
- ⌚ : Baking end time symbol \*
- 🔔 : Alarm symbol
- : Brightness symbol
- 🔒 : Key lock symbol
- 🌡️ : Temperature symbol
- 🔊 : Volume level symbol
- 🚪 : Door lock symbol \*

\*It varies depending on the product model. It may not be available on your product.

### Cooking by setting the cooking time:

- ✓ You can have the oven turn off automatically at the end of the time by selecting the gas level specific to your food and setting the cooking time on the timer.
  - Open oven door.
  - Put your food in the oven.
  - Keep gas oven control knob pressed and turn it **counterclockwise**.
  - Press ignition button and release it again.
  - Keep the gas oven control knob pressed for 3 to 5 seconds.
    - ⇒ Repeat the process until the emanating gas is ignited.

6. Keep the gas oven control knob pressed for another 3 to 5 seconds.
7. Select the desired baking power/ gas mark.
8. If there is no electricity; ignite the gas with the gas lighter from the ignition control hole.
9. Touch the ⌚ key until the ⌚ symbol appears on the display for the cooking time.

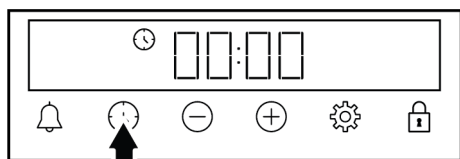

**i** After setting the operation function and temperature, you can set the cooking time for 30 minutes by touching the ⊕ key directly for quick setting of the cooking time and change the time with the ⊕/⊖ keys.

10. Set the cooking time with the ⊕/⊖ keys.

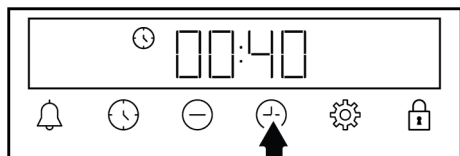

**i** The cooking time increases by 1 minute in the first 15 minutes, after 15 minutes it increases by 5 minutes.

⇒ The set cooking time starts to count down and the ⌚ symbol appears on the display.

11. After the set cooking time is completed, on the display, “End” appears, the ⌚ symbol flashes and the timer beeps.
12. The warning sounds for two minutes. Press any key to stop the warning. The warning stops and the time of day appears on the display.

## 7.2.1 Settings

### Activating the key lock

By using the key lock feature, you can safeguard the timer from interference.

1. Touch the key until the 🔒 symbol appears on the display.

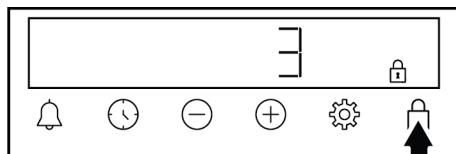

⇒ The 🔒 symbol is shown on the display and the 3-2-1 count down starts. The key lock activates when the countdown ends. When any key is touched after the key lock is set, the timer sounds an audible signal and the 🔒 symbol flashes.

**i** If you release the key before the end of the countdown, the key lock does not activate.

**i** Timer keys cannot be used when the key lock is on. The key lock will not be cancelled in case of power failure.

### Deactivating the key lock

1. Touch the key until the 🔒 symbol disappears from the display.

⇒ The 🔒 symbol disappears from the display and the key lock is disabled.

### Setting the alarm

You can also use the timer of the product for any warning or reminder other than baking. The alarm clock has no effect on the oven operating functions. It is used for warning purposes. For example, you can use the alarm clock when you want to turn the food in the oven at a certain time. As soon as the time you set has expired, the timer gives you an audible warning.

**i** The maximum alarm time may be 23 hours 59 minutes.



1. Touch the 🔔 until the key 🔔 symbol appears on the display.

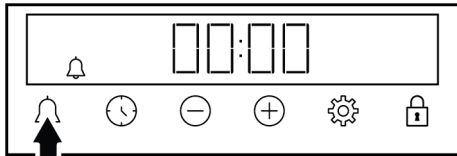

2. Set the alarm time with the ⊕/⊖ keys.

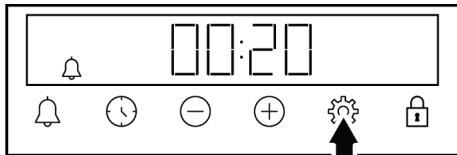

⇒ After setting the alarm time, the 🔔 symbol remains lit and the alarm time starts to countdown on the display. If the alarm time and baking time are set at the same time, the shorter time is shown on the display.

3. After the alarm time is completed, the 🔔 symbol starts flashing and gives you an audible warning.

### Turning off the alarm

1. At the end of the alarm period, the warning sounds for two minutes. Touch any key to stop the audible warning.

⇒ The warning stops and the time of day appears on the display.

### If you want to cancel the alarm;

1. Touch the 🔔 key until the 🔔 symbol appears on the display to reset the alarm time. Touch the ⊖ key until the "00:00" symbol appears on the display.
2. You can also cancel the alarm by touching the 🔔 key for a long time.

### Adjusting the volume

1. Touch ⚙️ key until the 🔊 symbol appears on the display.

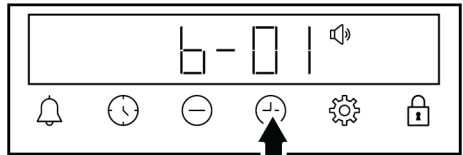

2. Set the desired level with the ⊕/⊖ keys. **(b-01-b-02-b-03)**

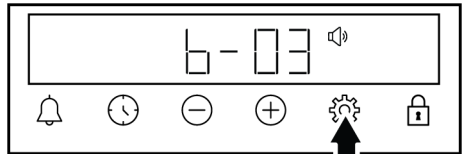

3. Touch the ⚙️ key for confirmation or wait without touching any key. The volume set becomes active after a while.

### Setting the display brightness

1. Touch ⚙️ key until the 🌙 symbol appears on the display.

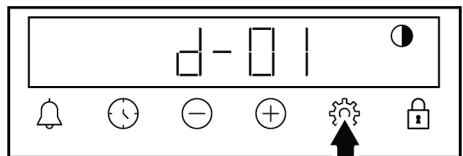

2. Set the desired brightness with the ⊕/⊖ keys. **(d-01-d-02-d-03)**

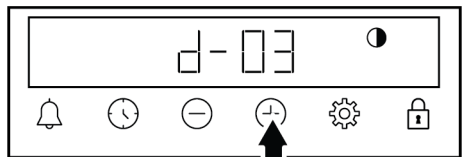

3. Touch the ⚙️ key for confirmation or wait without touching any key. The brightness set becomes active after a while.

### Changing the time of day

On your oven to change the time of day that you have previously set:

1. Touch the ⚙️ key until the 🕒 symbol appears on the display.
2. Set the time of day by touching the ⊕/⊖ keys.

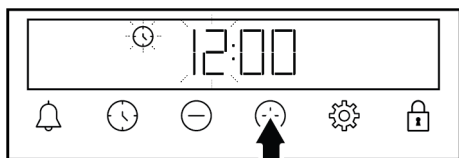

3. Touch or key to activate the minutes field.

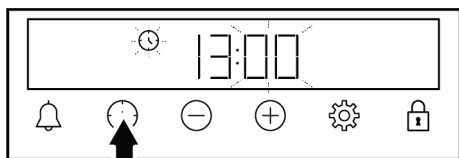

### 7.3 Using the upper section of the oven

#### Function knob - Upper cooking section

You can control your oven with oven control knob. No gas is supplied to the oven in the closed position (top). After igniting your oven burner, you can cook by adjusting the gas levels on the knob.

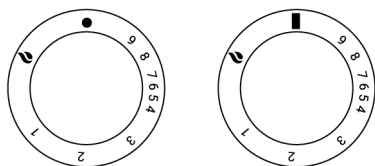

- Off position
- 1- Gas oven levels
- 9
- Grill

Gas level	Temperature (°C)
1	125
2	135
3	150
4	175
5	185
6	195
7	205
8	225
9	240

#### Turning on the gas oven

- ✓ The gas oven is ignited with the ignition button.

1. Open oven door.

4. Touch the / keys to set the minute.

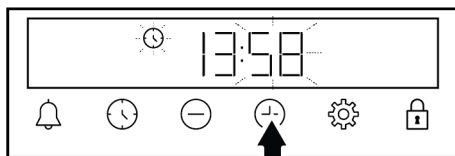

5. Confirm by touching the or key.

⇒ The time of day is set and the symbol disappears on the display.

2. Keep gas oven control knob pressed and turn it **counterclockwise** to one of the high temperature levels.
3. Press and release the ignition button.
  - ⇒ Repeat the procedure until the released gas is ignited.
4. Keep the gas oven control knob pressed for about 3 or 5 seconds more until making sure that oven heater is ignited.
5. Select the desired gas power.
6. If electricity is cut-off, ignite the oven heater with a match or lighter from the ignition control hole.

#### Turning off the gas oven

1. Turn the gas oven control knob to Off (upper) position.

Product is equipped with a security valve. When the flame goes out, gas supply is cut automatically. Thus, gas accumulation is prevented.



There is the risk of gas compression and explosion!

Do not attempt to ignite the gas more than 15 seconds. If the burner is not ignited within 15 seconds, turn off the knob and wait for 1 minute. Ventilate the room before reattempting to ignite the burner. There is the risk of gas compression and explosion!

### Turning on the gas grill

Oven door must remain open while grilling. There is a switch on the door. As a safety precaution, this switch prevents operation of the grill when the door is CLOSED.

- ✓ Gas grill is ignited with the ignition button.

1. Open the oven door.

2. Keep the knob pressed and turn it **clockwise** to the grill symbol.
3. Press and release the ignition button.
4. Repeat the procedure until the gas is ignited.
5. Keep the knob pressed for 3 to 5 seconds more.
6. Make sure that the grill is ignited.

### Turning off the gas grill

1. Turn the Grill control knob to Off (upper) position.



Foods that are not suitable for grilling carry the risk of fire. Only grill food which is suitable for intensive grilling heat. Do not place the food too far in the back of the grill. This is the hottest area and fatty food may catch fire.

## 8 General Information About Baking

You can find tips on preparing and cooking your food in this section.

Plus, this section describes some of the foods tested as producers and the most appropriate settings for these foods. Appropriate oven settings and accessories for these foods are also indicated.

### 8.1 General warnings about cooking with hob

#### General warnings about cooking with hob

- Never fill the pan with oil more than one third of it. Do not leave the hob unattended when heating oil. Overheated oils bring risk of fire. Never attempt to extinguish a possible fire with water! When oil catches fire, cover it with a fire blanket or damp cloth. Turn off the hob if it is safe to do so and call the fire department.
- Before frying foods, always remove their excess water and put them inside the heated oil slowly. Make sure that frozen foods are defrosted before frying.
- When heating oil, make sure that the pot you use is dry and keep its lid open.

- For recommendations on cooking with power saving, refer to the "Environmental Instructions" section.
- The cooking temperature and time values given for foods may vary depending on the recipe and amount. For this reason, these values are given as ranges.

### 8.2 General Warnings About Baking in the Oven

- While opening the oven door during or after baking, hot-burning steam may emerge. The steam may burn your hand, face and/or eyes. When opening the oven door, stay away.
- Intense steam generated during baking may form condensed water drops on the interior and exterior of the oven and on the upper parts of the furniture due to the temperature difference. This is a normal and physical occurrence.

- The cooking temperature and time values given for foods may vary depending on the recipe and amount. For this reason, these values are given as ranges.
- Always remove unused accessories from the oven before you start cooking. Accessories that will remain in the oven may prevent your food from being cooked at the correct values.
- For foods that you will cook according to your own recipe, you can reference similar foods given in the cooking tables.
- Using the supplied accessories ensures you get the best cooking performance. Always observe the warnings and information provided by the manufacturer for the external cookware you will use.
- Cut the greaseproof paper you will use in your cooking in suitable sizes to the container you will cook. Greaseproof papers that are overflowing from the container can create a risk of burns and affect the quality of your baking. Use the greaseproof paper you will use in the temperature range specified.
- For good baking performance, place your food on the recommended correct shelf. Do not change the shelf position during baking.
- The cooking status of the foods may vary depending on the amount of food and the size of the cookware.
- Metal, ceramic and glass moulds extend the cooking time and the bottom surfaces of pastry foods do not brown evenly.
- If you are using baking paper, a small browning can be observed on the bottom surface of the food. In this situation, you may have to extend your cooking period by approximately 10 minutes.
- The values specified in the cooking tables are determined as a result of the tests carried out in our laboratories. Values suitable for you may differ from these values.
- Place your food on the appropriate shelf recommended in the cooking table. Refer to the bottom shelf of the oven as shelf 1.

## 8.2.1 Pastries and oven food

### General Information

- We recommend using the accessories of the product for a good cooking performance. If you will use an external cookware, prefer dark, non-sticking and heat resistant ware.
- If preheating is recommended in the cooking table, be sure to put your food in the oven after preheating.
- If you will cook by using cookware on the wire grill, place it in the middle of the wire grill, not near the back wall.
- All materials used in making pastry should be fresh and at room temperature.

### Tips for baking cakes

- If the cake is too dry, increase the temperature by 10°C and shorten the baking time.
- If the cake is moist, use a small amount of liquid or reduce the temperature by 10°C.
- If the top of the cake is burnt, put it on the lower shelf, lower the temperature and increase the baking time.
- If the inside of the cake is cooked well, but outside is sticky, use less liquid, decrease the temperature and increase the cooking time.

### Hints for pastry

- If the pastry is too dry, increase the temperature by 10 °C and shorten the cooking time. Wet the dough sheets with a sauce consisting of milk, oil, egg and yoghurt mixture.
- If the pastry is getting cooked slowly, make sure that the thickness of the pastry you have prepared does not overflow the tray.
- If the pastry is browned on the surface but the bottom is not cooked, make sure that the amount of sauce you will use for the pastry is not too much at the bottom

of the pastry. For an even browning, try to spread the sauce evenly between the dough sheets and the pastry.

- Bake your pastry in the position and temperature appropriate to the cooking table. If the bottom is still not browned enough, place it on a bottom shelf for the next cooking.

### Cooking table for the upper cooking section

Food	Accessory to be used	Shelf position	Gas level	Baking time (min) (approx.)
Cookie	Small tray on wire grill *	1	4	40 ... 50
Bun	Small tray on wire grill *	1	5	30 ... 40
Pizza	Small tray on wire grill *	1	6	15 ... 25

10 minutes preheating is recommended for all food.

\*These accessories may not be included with your product.

\*\*These accessories are not included with your product. They are commercially available accessories.

### Cooking table for the bottom cooking section

Food	Accessory to be used	Shelf position	Gas level	Baking time (min) (approx.)
Cake on the tray	Small tray on wire grill *	3	4	55 ... 65
Cake in the mould	Cake mould on wire grill** **	3	4	55 ... 65
Small cakes	Small tray on wire grill *	4	4	25 ... 35
Cookie	Small tray on wire grill *	4	4	35 ... 45
Pastry	Small tray on wire grill *	3	5	40 ... 50
Bun	Small tray on wire grill *	3	5	25 ... 35
Whole bread	Small tray on wire grill *	3	6	35 ... 45
Lasagne	Small tray on wire grill *	3	6	35 ... 45
Apple pie	Round black metal mould, 20 cm in diameter on wire grill **	3	6	50 ... 70
Pizza	Small tray on wire grill *	3	6	20 ... 30

10 minutes preheating is recommended for all food.

\*These accessories may not be included with your product.

\*\*These accessories are not included with your product. They are commercially available accessories.

## 8.2.2 Meat, Fish and Poultry

### The key points on grilling

- Seasoning it with lemon juice and pepper before cooking whole chicken, turkey and large pieces of meat will increase cooking performance.
- It takes 15 to 30 minutes more to cook boned meat than fillet by frying.
- You should calculate about 4 to 5 minutes of cooking time per centimetre of the meat thickness.
- After the cooking time is expired, keep the meat in the oven for approximately 10 minutes. The juice of the meat is better distributed to the fried meat and does not come out when the meat is cut.
- Fish should be placed on the medium or low level shelf in a heat resistant plate.

- Cook the recommended dishes in the cooking table with a single tray.

### Cooking table for the bottom cooking section

Food	Accessory to be used	Shelf position	Gas level	Baking time (min) (approx.)
Steak (whole) / Roast (1 kg)	Small tray on wire grill *	3	20 mins. 8, after 4	80 ... 100
Lamb's shank (1,5-2 kg)	Small tray on wire grill *	3	20 mins. 8, after 4	130 ... 150
Fried chicken (1,8-2 kg)	Wire grill * Place one tray on a lower shelf	3	20 mins. 8, after 4	100 ... 120
Turkey (5,5 kg)	Small tray on wire grill *	2	20 mins. 8, after 4	170 ... 230
Fish	Wire grill * Place one tray on a lower shelf	3	6	30 ... 40

10 minutes preheating is recommended for all food.

\*These accessories may not be included with your product.

\*\*These accessories are not included with your product. They are commercially available accessories.

### 8.2.3 Grill

Red meat, fish and poultry meat quickly turns brown when grilled, holds a beautiful crust and does not dry out. Fillet meats, skewer meats, sausages as well as juicy vegetables (tomatoes, onions, etc.) are particularly suitable for grilling.

#### General warnings

- Food not suitable for grilling carries a fire hazard. Grill only food that is suitable for heavy grill fire. Also, do not place the food too far in the back of the grill. This is the hottest area and fatty foods may catch fire.
- **Keep the oven door open during grilling. Since the door will be open during grilling, hot surfaces may cause burns! Keep children away from the product.**

### The key points of the grill

- Prepare foods of similar thickness and weight as much as possible for the grill.
- Place the pieces to be grilled on the wire grill or wire grill tray by distributing them without exceeding the dimensions of the heater.
- Depending on the thickness of the pieces to be grilled, the cooking times given in the table may vary.
- Slide the wire grill or the wire grill tray to the desired level in the oven. If you are cooking on the wire grill, slide the oven tray to the lower shelf to collect the oils. The oven tray you will slide should be sized to cover the entire grill area. This tray may not be supplied with the product. Put some water into the oven tray for easy cleaning.

### Cooking table for the upper cooking section

Food	Accessory to be used	Shelf position	Baking time (min) (approx.)
Fish	Wire grill in tray on wire grill	1	20 ... 25
Chicken pieces	Wire grill in tray on wire grill	1	25 ... 35
Meatball (veal) - 12 amount	Wire grill in tray on wire grill	1	20 ... 30
Lamb chop	Wire grill in tray on wire grill	1	20 ... 25

Food	Accessory to be used	Shelf position	Baking time (min) (approx.)
Steak - (meat cubes)	Wire grill in tray on wire grill	1	25 ... 30
Veal chop	Wire grill in tray on wire grill	1	25 ... 30
Vegetable gratin	Wire grill in tray on wire grill	1	20 ... 30
Toast bread	Wire grill in tray on wire grill	1	1 ... 3
10 minutes preheating is recommended for all food. Turn pieces of food after 1/2 of the total grilling time.			

### 8.2.4 Test foods

- Foods in this cooking table are prepared according to the EN 60350-1 standard to facilitate testing of the product for control institutes.

### Cooking table for the upper cooking section

Food	Accessory to be used	Shelf position	Baking time (min) (approx.)
Meatball (veal) - 12 amount	Wire grill in tray on wire grill	1	20 ... 30
Toast bread	Wire grill in tray on wire grill	1	1 ... 3
10 minutes preheating is recommended for all food. Turn pieces of food after 1/2 of the total grilling time.			

### Cooking table for the bottom cooking section

Food	Accessory to be used	Shelf position	Gas level	Baking time (min) (approx.)
Cake in the mould	Cake mould on wire grill** **	3	4	55 ... 65
Small cakes	Small tray on wire grill *	4	4	25 ... 35
Apple pie	Round black metal mould, 20 cm in diameter on wire grill **	3	6	50 ... 70

10 minutes preheating is recommended for all food.

\*These accessories may not be included with your product.

\*\*These accessories are not included with your product. They are commercially available accessories.

## 9 Maintenance and Cleaning

### 9.1 General Cleaning Information

#### General warnings

- Wait for the product to cool before cleaning the product. Hot surfaces may cause burns!
- Do not apply the detergents directly on the hot surfaces. This may cause permanent stains.
- The product should be thoroughly cleaned and dried after each operation. Thus, food residues shall be easily cleaned and these residues shall be prevented from burning when the product is used again later. Thus, the service life of the appliance extends and frequently faced problems are decreased.
- Do not use steam cleaning products for cleaning.
- Some detergents or cleaning agents cause damage to the surface. Unsuitable cleaning agents are: bleach, cleaning products containing ammonia, acid or

- chloride, steam cleaning products, descaling agents, stain and rust removers, abrasive cleaning products (cream cleaners, scouring powder, scouring cream, abrasive and scratching scrubber, wire, sponges, cleaning cloths containing dirt and detergent residues).
- No special cleaning material is needed in the cleaning made after each use. Clean the appliance using dishwashing detergent, warm water and a soft cloth or sponge and dry it with a dry cloth.
  - Be sure to completely wipe off any remaining liquid after cleaning and immediately clean any food splashing around during cooking.
  - Do not wash any component of your appliance in a dishwasher unless otherwise stated in the user's manual.

#### **For the hobs:**

- Acidic dirt such as milk, tomato paste and oil may cause permanent stains on the hobs and components of the hob zones, clean any overflowed fluids immediately after cooling down the hob by turning it off.
- Wok type burners used at high temperatures may change colour. This is normal.
- Moving some cookware may cause metal marks on the pot holders. Do not slide the pans and pots on the surface.
- As hob zone caps contact the fire directly and exposed to high temperatures, change and loss of colour in time is normal. This does not cause a problem while using the hob.

#### **Inox - stainless surfaces**

- Do not use acid or chlorine-containing cleaning agents to clean stainless-inox surfaces and handles.
- Stainless-inox surface may change colour in time. This is normal. After each operation, clean with a detergent suitable for the stainless or inox surface.
- Clean with a soft soapy cloth and liquid (non-scratching) detergent suitable for inox surfaces, taking care to wipe in one direction.

- Remove lime, oil, starch, milk and protein stains on the glass and inox surfaces immediately without waiting. Stains may rust under long periods of time.
- Cleaners sprayed/applied to the surface should be cleaned immediately. Abrasive cleaners left on the surface cause the surface to turn white.

#### **Enamelled surfaces**

- The oven must cool down before cleaning the cooking area. Cleaning on hot surfaces shall create both fire hazard and damage the enamel surface.
- After each use, clean the enamel surfaces using dishwashing detergent, warm water and a soft cloth or sponge and dry them with a dry cloth.
- For difficult stains, an oven and grill cleaner recommended on the website of your product brand and a non-scratching scouring pad can be used. Do not use an external oven cleaner.

#### **Catalytic surfaces**

- The side walls in the cooking area can only be covered with enamel or catalytic walls. It varies by model.
- The catalytic walls have a light matte and porous surface. The catalytic walls of the oven should not be cleaned.
- Catalytic surfaces absorb oil thanks to its porous structure and start to shine when the surface is saturated with oil, in this case it is recommended to replace the parts.

#### **Glass surfaces**

- When cleaning glass surfaces, do not use hard metal scrapers and abrasive cleaning materials. They can damage the glass surface.
- Clean the appliance using dishwashing detergent, warm water and a microfiber cloth specific for glass surfaces and dry it with a dry microfiber cloth.
- If there is residual detergent after cleaning, wipe it with cold water and dry with a clean and dry microfiber cloth. Residual detergent may damage the glass surface next time.



- Under no circumstances should the dried-up residue on the glass surface be cleaned off with serrated knives, wire wool or similar scratching tools.
- You can remove the calcium stains (yellow stains) on the glass surface with the commercially available descaling agent, with a descaling agent such as vinegar or lemon juice.
- If the surface is heavily soiled, apply the cleaning agent on the stain with a sponge and wait a long time for it to work properly. Then clean the glass surface with a wet cloth.
- Discolorations and stains on the glass surface are normal and not defects.

### **Plastic parts and painted surfaces**

- Clean plastic parts and painted surfaces using dishwashing detergent, warm water and a soft cloth or sponge and dry them with a dry cloth.
- Do not use hard metal scrapers and abrasive cleaners. They may damage the surfaces.
- Ensure that the joints of the components of the product are not left damp and with detergent. Otherwise, corrosion may occur on these joints.

## **9.2 Cleaning Accessories**

Do not put the product accessories in a dishwasher unless otherwise stated in the user's manual.

## **9.3 Cleaning the hob**

### **Cleaning the gas burners**

1. Before cleaning the hob, remove pot holders, burner caps and heads from the hob.
2. Clean the surface of the hob as per the recommendations included in the general cleaning information according to the surface type (enamelled, glass, inox, etc.).
3. Clean the burner chamber with a cloth soaked in detergent or with non-scratching, soft brush. Ensure that no food remains are left.

4. Clean the spark plugs and thermal elements (in models with ignition and thermal element) with a well squeezed cloth. Then dry with a clean cloth. Pay attention that the spark plug and the thermal element are completely dry.
5. Clean the burner caps and heads with detergent water after each operation and then dry them.
6. For persistent stains, keep burner caps and heads in detergent water or warm soapy water at least for 15 minutes. Clean with a non-metallic and non-scratching brush.
7. You may use the Quick&Shine cleaning agents for the oven interiors and grills, used on enamelled surfaces and recommended by the authorized service, especially for persistent stains on enamelled burner caps.
8. Do not contact burner caps with aggressive detergents such as oven interior cleaning agents, descalers while cleaning them, this may cause discoloration.
9. Clean the pot holders with detergent water and non-scratching, soft brush after each operation and then dry them.
10. When the burner caps and pot holders are used as wet, persistent lime stains may occur as a result of the heat. Ensure that it is dried before operation.
11. Place burner heads, caps and pot holders respectively.
12. When placing the pot holders, ensure that they centre the burners. In pin models, fit the pins on the burner plate to the pin slots on the pot holders.

### **Assembling the burner parts**

1. Place the parts as in the figure after cleaning the burners.

- Place the burner head ensuring that it passes through the burner spark plug (4). Turn the burner head right and left to make sure that it is seated in the burner chamber.
- Place the burner cap on the burner head.

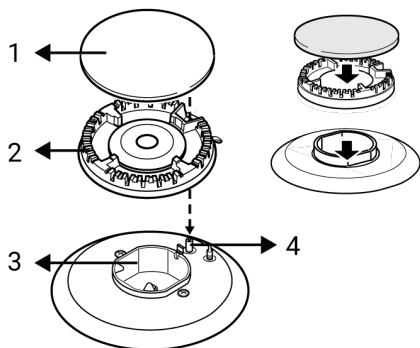

- 1 Burner cap
- 2 Burner head
- 3 Burner chamber
- 4 Spark plug (in models with ignition)

## 9.4 Cleaning the Control Panel

- When cleaning the panels with knob-control, wipe the panel and knobs with a damp soft cloth and dry with a dry cloth. Do not remove the knobs and gaskets underneath to clean the panel. The control panel and knobs may be damaged.
- While cleaning the inox panels with knob control, do not use inox cleaning agents around the knob. The indicators around the knob can be erased.
- Clean the touch control panels with a damp soft cloth and dry with a dry cloth. If your product has a key lock feature, set the key lock before performing control panel cleaning. Otherwise, incorrect detection may occur on the keys.

## 9.5 Cleaning the inside of the oven (cooking area)

Follow the cleaning steps described in the "General Cleaning Information" section according to the surface types in your oven.

## Cleaning the side walls of the oven

The side walls in the cooking area can only be covered with enamel or catalytic walls. It varies by model. If there is a catalytic wall, refer to the "Catalytic surfaces" section for information.

If your product is a wire shelf model, remove the wire shelves before cleaning the side walls. Then complete the cleaning as described in the "General Cleaning Information" section according to the side wall surface type.

### To remove the side wire shelves:

- Remove the front of the wire shelf by pulling it on the side wall in the opposite direction.
- Pull the wire shelf towards you to remove it completely.

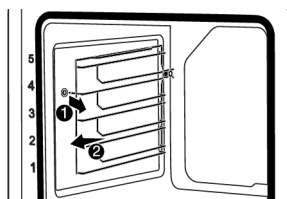

- To reattach the shelves, the procedures applied when removing them must be repeated from the end to the beginning, respectively.

## 9.6 Cleaning The Upper Oven Door

You can remove your upper oven door and door glasses to clean them. How to remove the doors and windows is explained in the sections "**Removing the upper oven door**" and "**Removing the inner glasses of the upper door**". After removing the door inner glasses, clean them using a dishwashing detergent, warm water and a soft cloth or sponge and dry them with a dry cloth. For lime residue that may form on the oven glass, wipe the glass with vinegar and rinse.



Do not use harsh abrasive cleaners, metal scrapers, wire wool or bleach materials to clean the oven door and glass.

## Removing the oven door

1. Open the oven door.
2. Open the clips in the front door hinge socket on the right and left by pushing them downwards as shown in the figure.
3. Hinge types vary as (A), (B), (C) types according to the product model. The following figures show how to open each type of hinge.
4. (A) type hinge is available in normal door types.

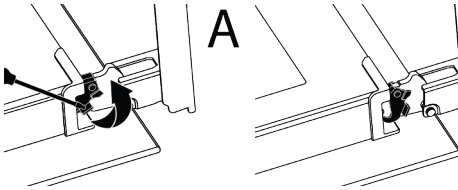

5. (B) type hinge is available in soft closing door types.

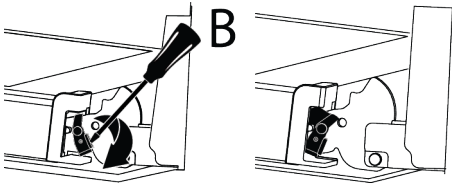

6. (C) type hinge is available in soft opening/closing door types.

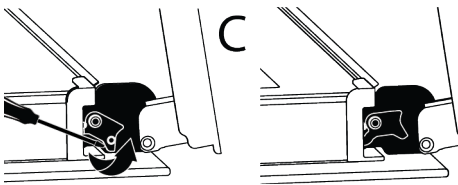

7. Get the oven door to a half-open position.

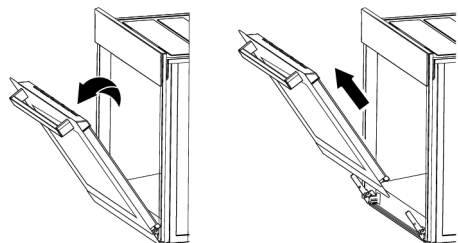

8. Pull the removed door upwards to release it from the right and left hinges and remove it.



To reattach the door, the procedures applied when removing it must be repeated from the end to the beginning, respectively. When installing the door, be sure to close the clips on the hinge socket.

## 9.7 Removing the Inner Glass of The Upper Oven Door

Inner glass of the product's front upper oven door may be removed for cleaning.

1. Open the oven door.

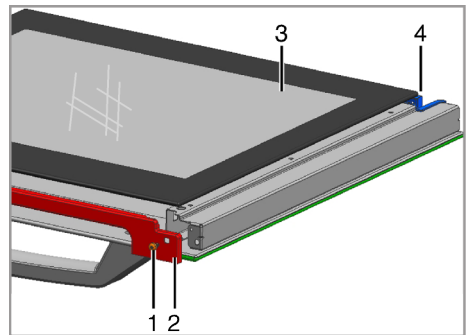

- 1 Screw
- 2 Profile
- 3 Inner glass pane
- 4 Plastic slot

2. Take out the screw(1) with a screwdriver.
3. Take out the profile (2) than hold up to inner glass (3).
4. Then group the door again, put the glass pane (3) to the plastic slots (4) and group the profile.

1. Open the oven door.
2. Remove the plastic component attached on the upper section of the front door by pulling it towards yourself.

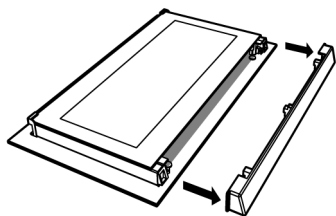

- As shown in the figure, gently lift the innermost glass (1) towards “A” and then, remove it by pulling towards “B”.

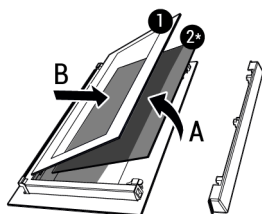

- 1 Innermost glass      2\* Inner glass (it may not be available for your product)

- If your product has an inner glass (2), repeat the same process to detach it (2).
- The first step of regrouping the door is to reassemble the inner glass (2). Place the bevelled edge of the glass to meet the bevelled edge of the plastic slot. (If your product has an inner glass). Inner glass (2) must be attached to the plastic slot closest to the innermost glass (1).
- While reassembling the innermost glass (1), pay attention to place the printed side of the glass on the inner glass. It is crucial to place the lower corners of the innermost glass (1) to meet the lower plastic slots.
- Push the plastic component towards the frame until a “click” sound is heard.

## 9.8 Cleaning the Oven Lamp

In the event that the glass door of the oven lamp in the cooking area becomes dirty; clean using dishwashing detergent, warm water and a soft cloth or sponge and dry

with a dry cloth. In case of oven lamp failure, you can replace the oven lamp by following the sections that follow.

## Replacing the oven lamp

### General Warnings

- To avoid the risk of electric shock before replacing the oven lamp, disconnect the product and wait for the oven to cool. Hot surfaces may cause burns!
- This oven is powered by an incandescent lamp with less than 40 W, less than 60 mm in height, less than 30 mm in diameter, or a halogen lamp with G9 sockets with less than 60 W power. Lamps are suitable for operation at temperatures above 300 °C. Oven lamps are available from Authorised Services or licensed technicians. This product contains a G energy class lamp.
- The position of the lamp may differ from that is shown in the figure.
- The lamp used in this product is not suitable for use in the lighting of home rooms. The purpose of this lamp is to help the user see food products.
- The lamps used in this product must withstand extreme physical conditions such as temperatures above 50 °C.

### If your oven has a round lamp,

- Disconnect the product from the electricity.
- Remove the glass cover by turning it counter clockwise.

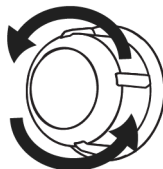

- If your oven lamp is type (A) shown in the figure below, rotate the oven lamp as shown in the figure and replace it with a new one. If it is type (B) model, pull it out as shown in the figure and replace it with a new one.

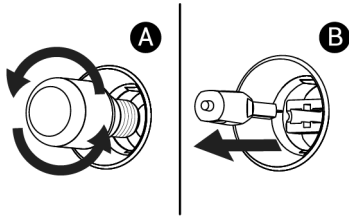

4. Refit the glass cover.

**If your oven has a square lamp,**

1. Disconnect the product from the electricity.
2. Remove the wire shelves according to the description.

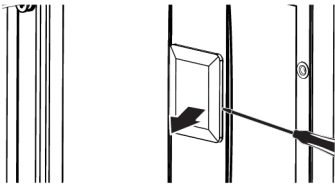

3. Lift the lamp's protective glass cover with a screwdriver. Remove the screw first, if there is a screw on the square lamp in your product.
4. If your oven lamp is type (A) shown in the figure below, rotate the oven lamp as shown in the figure and replace it with a new one. If it is type (B) model, pull it out as shown in the figure and replace it with a new one.

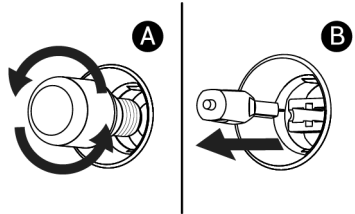

5. Refit the glass cover and wire shelves.

## 10 Troubleshooting

If the problem persists after following the instructions in this section, contact your vendor or an Authorized Service. Never try to repair your product yourself.

**Steam is emanated while the oven is working.**

- It is normal to see vapour during operation. >>> This is not an error.

**Water droplets appear while cooking**

- The steam generated during cooking condenses when it comes into contact with cold surfaces outside the product and may form water droplets. >>> This is not an error.

**Metal sounds are heard while the product is warming and cooling.**

- Metal parts may expand and make sounds when heated. >>> This is not an error.

**The product does not work.**

- Fuse may be faulty or blown. >>> Check the fuses in the fuse box. Change them if necessary or reactivate them.

- The appliance may not be plugged to the (grounded) outlet. >>> Check if the appliance is plugged in to the outlet.
- (If there is timer on your appliance) Keys on the control panel do not work. >>> If your product has a key lock, the key lock may be enabled, disable the key lock.

**Oven light is not on.**

- Oven lamp may be faulty. >>> Replace oven's lamp.
- No electricity. >>> Ensure the mains is operational and check the fuses in the fuse box. Change the fuses if necessary or reactivate them.

**There is no ignition spark.**

- There is no current. >>> Check the fuses in the fuse box.
- For the models with timer, the time is not set. >>> Set the time.

**(For models with timer) The timer display flashes or the timer symbol is left open.**

- There has been a power outage before. >>> Set the time / Turn off the product function knobs and again switch it to the desired position.





