

Built-in Hob

User manual

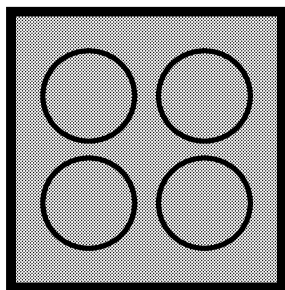

HCMW64225SX

EN

185.9268.35/R.AB/28.12.2016

Please read this user manual first!

Dear Customer,

Thank you for purchasing this Beko product. We hope that you get the best results from your product which has been manufactured with high quality and state-of-the-art technology. Therefore, please read this entire user manual and all other accompanying documents carefully before using the product and keep it as a reference for future use. If you handover the product to someone else, give the user manual as well. Follow all warnings and information in the user manual.

Remember that this user manual is also applicable for several other models. Differences between models will be identified in the manual.

Explanation of symbols

Throughout this user manual the following symbols are used:



Important information or useful hints about usage.



Warning of hazardous situations with regard to life and property.



Warning of electric shock.



Warning of risk of fire.



Warning of hot surfaces.

Arçelik A.Ş.

Karaağaç caddesi No:2-6
34445 Sütlüce/İstanbul/TURKEY

Made in TURKEY



This product was manufactured using the latest technology in environmentally friendly conditions.

TABLE OF CONTENTS

1 Important instructions and warnings for safety and environment 4

Intended use	4
General safety	4
Safety when working with gas	5
Electrical safety	6
Product safety	6
Safety for children.....	7
Disposing of the old product.....	7
Package information	8
Future Transportation.....	8

2 General information 9

Overview	9
Technical specifications	10
Injector table	10

3 Installation 11

Before installation	11
Installation and connection	12
Gas conversion	14

4 Preparation 16

Tips for saving energy	16
Initial use	16
First cleaning of the appliance.....	16

5 How to use the hob 17

General information about cooking	17
Using the hobs	17

6 Maintenance and care 19

General information	19
Cleaning the hob	19
Cleaning the control panel	19

7 Troubleshooting 20

8 Guarantee Details 21

1 Important instructions and warnings for safety and environment

This section contains safety instructions that will help protect from risk of personal injury or property damage. Failure to follow these instructions shall void any warranty.

Intended use

CAUTION

- This appliance is designed for cooking purposes only, and is intended for indoor domestic household and static home use only.
- This appliance should not be used for any other purpose or in any other application, such as for non-domestic use or in a commercial environment.
- In addition this appliance is not suitable for use on any type of boat (offshore, inland waterway, canal boat or houseboat), caravans or motor homes. Installation in static caravans and mobile homes is permitted.
- Incorrect installation environments will void the guarantee.
- This appliance should not be used for room heating purposes.
- The manufacturer shall not be liable for any damage caused by improper use or handling.

General safety

- This appliance can be used by children aged from 8 years and above and persons with reduced physical, sensory or mental capabilities or lack of experience and knowledge if they have been given supervision or instruction concerning use of the appliance in a safe way and understand the hazards involved.
Children shall not play with the appliance. Cleaning and user maintenance shall not be made by children without supervision.
- Installation and repair procedures must always be performed by Authorized Service Agents. The manufacturer shall not be held responsible for damages arising from procedures carried out by unauthorized persons which may also void the warranty. Before installation, read the instructions carefully.
- Do not operate the product if it is defective or has any visible damage.
- Ensure that the product function knobs are switched off after every use.

Safety when working with gas

- Any works on gas equipment and systems may only be carried out by authorised qualified persons who are Gas Safe registered.
- Prior to the installation, ensure that the local distribution conditions (nature of the gas and gas pressure) and the adjustment of the appliance are compatible.
- This appliance is not connected to a combustion products or evacuation device. It shall be installed and connected in accordance with current installation regulations. Particular attention shall be given to the relevant requirements regarding ventilation; See *Before installation, page 11*
- The use of gas cooking appliance results in the production of heat and moisture in the room in which it is installed. Ensure that the kitchen is well ventilated: keep natural ventilation holes open or install a mechanical ventilation device (mechanical extractor hood). Prolonged intensive use of the appliance may call for additional ventilation, for example increasing the level of the mechanical ventilation where present.
- Gas appliances and systems must be regularly checked for proper functioning. Regulator, hose and its clamp must be checked regularly and replaced within the periods recommended by its manufacturer or when necessary.
- Clean the gas burners regularly. The flames should be blue and burn evenly.
- Good combustion is required in gas appliances. In case of incomplete combustion, carbon monoxide (CO) might develop. Carbon monoxide is a colourless, odourless and very toxic gas, which has a lethal effect even in very small doses.
- Request information about gas emergency telephone numbers and safety measures in case of gas smell from you local gas provider.

What to do when you smell gas

- Do not use open flame or do not smoke. Do not operate any electrical buttons (e.g. lamp button, door bell and etc.) Do not use fixed or mobile phones. Risk of explosion and toxication!
- Open doors and windows.
- Turn off all valves on gas appliances and gas meter at the main control valve, unless it's in a confined space or cellar.
- Check all tubes and connections for tightness. If you still smell gas leave the property.

- Warn the neighbours.
- Call the fire-brigade. Use a telephone outside the house.
- Do not re-enter the property until you are told it is safe to do so.

Electrical safety

- If the product has a failure, it should not be operated unless it is repaired by an Authorized Service Agent. There is the risk of electric shock!
- Only connect the product to a grounded outlet/line with the voltage and protection as specified in the “Technical specifications”. Have the grounding installation made by a qualified electrician while using the product with or without a transformer. Our company shall not be liable for any problems arising due to the product not being earthed in accordance with the local regulations.
- Never wash the product by spreading or pouring water onto it! There is the risk of electric shock!
- The product must be disconnected during installation, maintenance, cleaning and repairing procedures.
- If the power connection cable for the product is damaged, it must be replaced by the manufacturer, its service agent or similarly

qualified persons in order to avoid a hazard.

- Only use the connection cable specified in the “Technical specifications”.
- The appliance must be installed so that it can be completely disconnected from the mains supply. The separation must be provided by a switch built into the fixed electrical installation, according to construction regulations.
- Any work on electrical equipment and systems should only be carried out by authorized and qualified persons.
- In case of any damage, switch off the product and disconnect it from the mains. To do this, turn off the fuse at home.
- Make sure that fuse rating is compatible with the product.

Product safety

- The appliance and its accessible parts become hot during use. Care should be taken to avoid touching heating elements. Children less than 8 years of age shall be kept away unless continuously supervised.
- Never use the product when your judgment or coordination is impaired by the use of alcohol and/or drugs.

- Be careful when using alcoholic drinks in your dishes. Alcohol evaporates at high temperatures and may cause fire since it can ignite when it comes into contact with hot surfaces.
- Do not place any flammable materials close to the product as the sides may become hot during use.
- Keep all ventilation slots clear of obstructions.
- Do not use steam cleaners to clean the appliance as this may cause an electric shock.
- Unattended cooking on a hob with fat or oil can be dangerous and may result in fire. NEVER try to extinguish a fire with water, but switch off the appliance and then cover flame e.g. with a lid or a fire blanket.
- Danger of fire: Do not store items on the cooking surfaces.

Prevention against possible fire risk!

- Ensure all electrical connections are secure and tight to prevent risk of arcing.
- Do not use damaged cables or extension cables.
- Ensure liquid or moisture is not accessible to the electrical connection point.
- To prevent gas leakage ensure that the gas connection is sound.

Safety for children

- Accessible parts may become hot during use. Young children should be kept away.
- The packaging materials will be dangerous for children. Keep the packaging materials away from children. Please dispose of all parts of the packaging according to environmental standards.
- Electrical and/or gas products are dangerous to children. Keep children away from the product when it is operating and do not allow them to play with the product.
- Do not place any items above the appliance that children may reach for.

Disposing of the old product

Compliance with the WEEE Directive and Disposing of the Waste Product:



This product complies with EU WEEE Directive (2012/19/EU). This product bears a classification symbol for waste electrical and electronic equipment (WEEE).

This product has been manufactured with high quality parts and materials which can be reused and are suitable for recycling. Do not dispose of the waste product with normal domestic and other wastes at the end of its service life. Take it to the collection center for the recycling of electrical and electronic equipment. Please consult your local authorities to learn about these collection centers.

Compliance with RoHS Directive:

The product you have purchased complies with EU RoHS Directive (2011/65/EU). It does not contain harmful and prohibited materials specified in the Directive.

Package information

- Packaging materials of the product are manufactured from recyclable materials in accordance with our National Environment Regulations. Do not dispose of the packaging materials together with the domestic or other wastes. Take them to the packaging material collection points designated by the local authorities.

Future Transportation

- Keep the product's original carton and transport the product in it. Follow the instructions on the carton. If you do not have the original carton, pack the product in bubble wrap or thick cardboard and tape it securely.
- Secure the caps and pan supports with adhesive tape.



Check the general appearance of your product for any damages that might have occurred during transportation.

2 General information

Overview

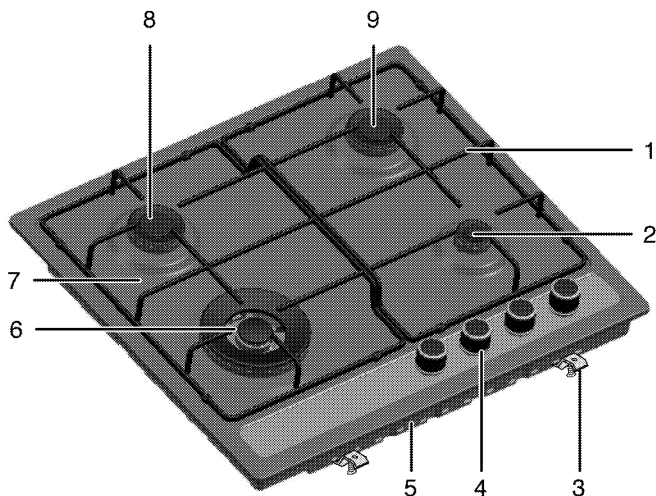

- 1 Pan support
- 2 Auxiliary burner
- 3 Assembly clamp
- 4 Control panel
- 5 Base cover

- 6 Wok burner
- 7 Burner plate
- 8 Normal burner
- 9 Normal burner

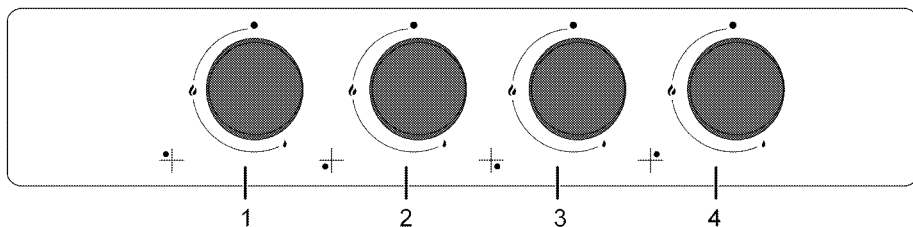

- 1 Normal burner Rear left
- 2 Wok burner Front left

- 3 Auxiliary burner Front right
- 4 Normal burner Rear right

Technical specifications

Voltage / frequency	220-240 V ~ 50 Hz
Cable type / section	H05V2V2-F 3 x 0,75 mm ² or equivalent
Category of gas product	II 2H3+
Gas type / pressure	NG G 20/20 mbar
Total gas consumption	7.8 kW
Converting the gas type / pressure ^s	LPG G 30/28-30 mbar
– optional	Propane 31/37 mbar
External dimensions (height / width / depth)	99 mm/580 mm/510 mm
Installation dimensions (width / depth)	560 mm/480-490 mm
Burners	
Rear left	Normal burner
Power	1.75 kW
Front left	Wok burner
Power	3.3kW
Front right	Auxiliary burner
Power	1 kW
Rear right	Normal burner
Power	1.75 kW



Technical specifications may be changed without prior notice to improve the quality of the product.



Figures in this manual are schematic and may not exactly match your product.



Values stated on the product labels or in the documentation accompanying it are obtained in laboratory conditions in accordance with relevant standards. Depending on operational and environmental conditions of the product, these values may vary.

Injector table

Position hob zone	1.75 kW Rear left	3.3kW Front left	1 kW Front right	1.75 kW Rear right
Gas type / Gas pressure				
G 20/20 mbar	97	132	78	97
G 30/28-30 mbar	66	92	50	66
G 31/ 37 mbar	66	92	50	66

3 Installation

CAUTION

- This appliance is designed for cooking purposes only, and is intended for indoor domestic household and static home use only.
- This appliance should not be used for any other purpose or in any other application, such as for non-domestic use or in a commercial environment.
- In addition this appliance is not suitable for use on any type of boat (offshore, inland waterway, canal boat or houseboat), caravans or motor homes.
Installation in static caravans and mobile homes is permitted.
- Incorrect installation environments will void the guarantee.
- This appliance should not be used for room heating purposes.
- The manufacturer shall not be liable for any damage caused by improper use or handling.

Product must be installed by a qualified person in accordance with the regulations in force. The manufacturer shall not be held responsible for damages arising from procedures carried out by unauthorized persons which may also void the warranty.



Preparation of location and electrical and gas installation for the product is under customer's responsibility.



DANGER:

The product must be installed in accordance with all local gas and/or electrical regulations.



DANGER:

Prior to installation, visually check if the product has any defects on it. If so, do not have it installed.
Damaged products cause risks for your safety.

Before installation

The hob is designed for installation into commercially available work tops. A safety distance must be left between the appliance and the kitchen walls and furniture. See figure (values in mm).

- It can also be used in a free standing position. Allow a minimum distance of 650 mm above the hob surface.
- (*) If a cooker hood is to be installed above the cooker, refer to cooker hood manufacturer' instructions regarding installation height (min 650 mm)
- Remove packaging materials and transport locks.
- Surfaces, synthetic laminates and adhesives used must be heat resistant (100 °C minimum).
- The worktop must be aligned and fixed horizontally.
- Cut aperture for the hob in worktop as per installation dimensions.

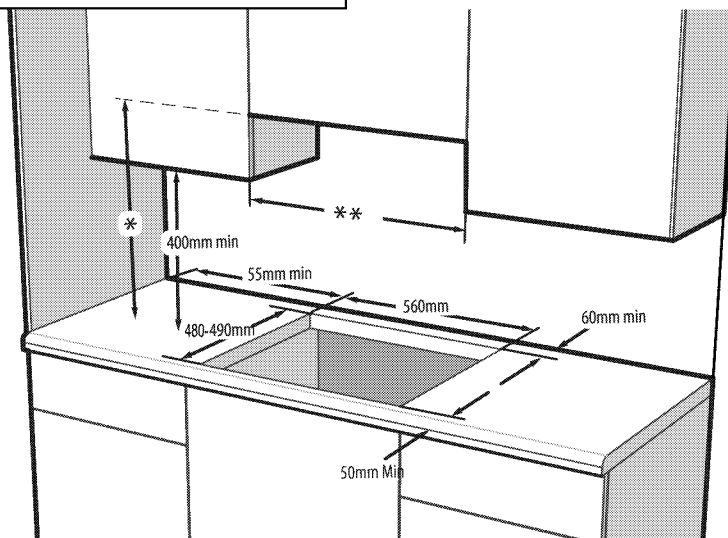

- * Minimum height to extractor as recommend in extractor instruction manual
- ** Minimum distance between cabinetry must be equal to width of hob

Room ventilation

All rooms require an openable window, or equivalent, and some rooms will require a permanent vent as well. The air for combustion is taken from the room air and the exhaust gases are emitted directly into the room. Good room ventilation is essential for safe operation of your appliance. If there is no window or door available for room ventilation, an extra ventilation must be installed.

The appliance may be located in a kitchen, kitchen/diner or a bed-sitting room, but not in a room containing a bath or shower. The appliance must not be installed in a bed-sitting room of less than 20m³. Do not install this appliance in a room below ground level unless it is open to ground level on at least one side.

Room size	Ventilation opening
smaller than 5 m ³	min. 100 cm ²
5 m ³ to 10 m ³	min. 50 cm ²
greater than 10 m ³	not required
In the cellar or basement	min. 65 cm ²

Installation and connection

- The product must be installed in accordance with all local gas and electrical regulations.

Electrical connection

Connect the product to a grounded outlet/line protected by a fuse of suitable capacity as stated in the "Technical specifications" table. Have the grounding installation made by a qualified electrician while using the product with or without a transformer. Our company shall not be liable for any damages that will arise due to using the product without a grounding installation in accordance with the local regulations.



DANGER:
The product must be connected to the mains supply only by an authorised and qualified person. The product's warranty period starts only after correct installation. Manufacturer shall not be held responsible for damages arising from procedures carried out by unauthorised persons.



DANGER:
The power cable must not be clamped, bent or trapped or come into contact with hot parts of the product.
A damaged power cable must be replaced by a qualified electrician. Otherwise, there is risk of electric shock, short circuit or fire!

- Connection must comply with national regulations.
- The mains supply data must correspond to the data specified on the type label of the product. Type label is at the rear housing of the product.
- Power cable of your product must comply with the values in "Technical specifications" table.



DANGER:
Before starting any work on the electrical installation, disconnect the product from the mains supply.
There is the risk of electric shock!

Connecting the power cable

1. **If a power cable is not supplied together with your product**, a power cable that you would select from the table in accordance with the electrical installation at your home must be connected to your product by following the instructions in cable diagram.

This product must only be connected by a qualified electrician such as a technician from the local electricity company or NICEIC registered contractor to a suitable double-pole control unit with a minimum contact clearance of 3 mm in all poles. This control unit must be installed accordance with the IEE regulation. Failure to obey this instruction may cause operational problems and invalidate the product warranty.



Additional protection by a residual current circuit breaker is recommended.

2. Open the terminal block cover with a screwdriver.
3. Insert the power cable through the cable clamp below the terminal and secure it to the main body with the integrated screw on cable clamping component.
4. Connect the cables according to the supplied diagram.

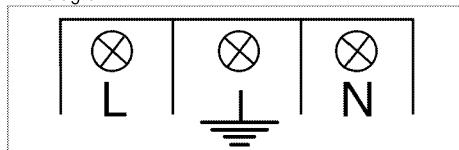

5. After completing the wire connections, close the terminal block cover.
6. Route the power cable so that it will not contact the product and get squeezed between the product and the wall.

i Power cable must not be longer than 2 m because of safety reasons.

Gas connection

! DANGER:
Product can be connected to gas supply system only by an authorised and qualified person or technician with licence.
Risk of explosion or toxication due to unprofessional repairs!
Manufacturer shall not be held responsible for damages arising from procedures carried out by unauthorised or unlicensed persons.

! DANGER:
Before starting any work on the gas installation, disconnect the gas supply.
There is the risk of explosion!

- Gas adjustment conditions and values are stated on labels (or ion type label).

i Your product is equipped for natural gas (NG).

- Natural gas installation must be prepared before installing the product.
- There must be a rigid or semi rigid pipe, (i.e. steel or copper) at the outlet of the installation for the natural gas connection of your product and the tip of this pipe must be closed with a blind plug. Service Representative will remove the blind plug during connection and connect your product by means of a straight connection device (coupling).
- Make sure that the natural gas valve is readily accessible.
- If you need to use your product later with a different type of gas, you must consult the Authorised Service Agent for the related conversion procedure.

Installing the product

1. Remove burners, burner caps and grills on the hob from the product.
2. Turning the hob upside down, place it on a flat surface.
3. In order to avoid the foreign substances and liquids penetrate between the hob and the counter,

please apply the putty supplied in the package on the contours of the lower housing of the hob but make sure that the putty does not overlap.

4. Fill the corners by forming bends at the corners as illustrated in the figure. Form as much bend as required to fill the gap in the corners.

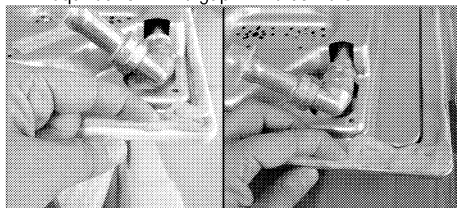

i Make sure that the skirting sections on the lower housing of the hob are filled with putty.

5. Place the hob on the counter and align it.

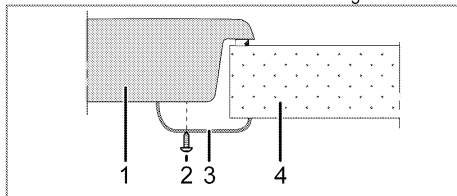

- 1 Hob
- 2 Screw
- 3 Installation clamp
- 4 Counter

i When installing the hob onto a cabinet, a shelf must be installed in order to separate the cabinet from the hob as illustrated in the above figure. This is not required when installing onto a built-under oven.

For example, if it is possible to touch the bottom of the product since it is installed onto a drawer, this section must be covered with a wooden plate.

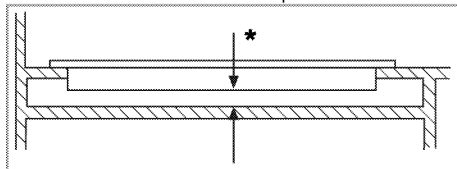

* min. 15 mm

Rear view (connection holes)

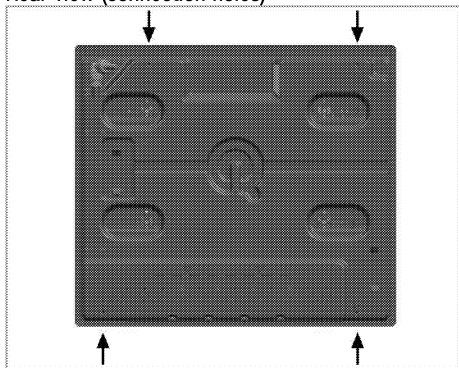

Place the burner plates, burner plate caps and grills back to their seating after installation.



DANGER:

Connection clamps will be supplied as installed onto the hob.
Making connections to different holes is not a good practice in terms of safety since it can damage the gas and electrical system.

Final check

1. Open gas supply.
2. Check gas installations for secure fitting and tightness.
3. Ignite burners and check appearance of the flame.



Flame must be blue and have a regular shape.
If the flame is yellowish, check if the burner cap is seated securely or clean the burner.

Gas conversion



DANGER:

Before starting any work on the gas installation, disconnect the gas supply.
There is the risk of explosion!

In order to change your appliance's gas type, change all injectors and make flame adjustment for all valves at reduced flow rate position.

Exchange of injector for the burners

1. Take off burner cap and burner body.
2. Unscrew injectors by turning the counter-clockwise.
3. Fit new injectors.
4. Check all connections for secure fitting and tightness.



New injectors have their position marked on their packing or injector table on *Injector table, page 10* can be referred to.

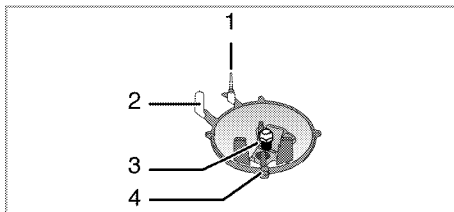

- 1 Flame failure device
- 2 Spark plug
- 3 Injector
- 4 Burner



Unless there is an abnormal condition, do not attempt to remove the gas burner taps. You must call an Authorised service agent if it is necessary to change the taps.

Reduced gas flow rate setting for hob taps

1. Ignite the burner that is to be adjusted and turn the knob to the reduced position.
2. Remove the knob from the gas tap.
3. Use an appropriately sized screwdriver to adjust the flow rate adjustment screw.

For LPG (Butane - Propane) turn the screw clockwise. For the natural gas, you should turn the screw **counter-clockwise** once.

» The normal length of a straight flame in the reduced position should be 6-7 mm.

4. If the flame is higher than the desired position, turn the screw clockwise. If it is smaller turn anticlockwise.
5. For the last control, bring the burner both to high-flame and reduced positions and check whether the flame is on or off.

Depending on the type of gas tap used in your appliance the adjustment screw position may vary.

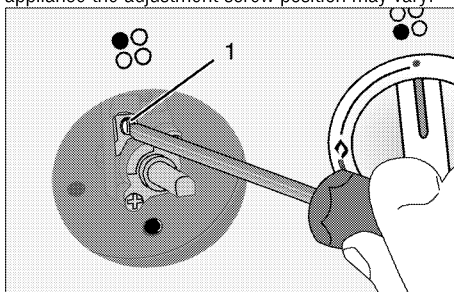

- 1 Flow rate adjustment screw

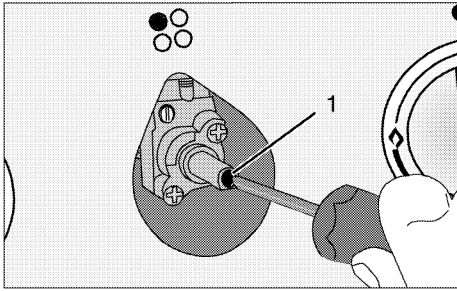

1 Flow rate adjustment screw



If the gas type of the unit is changed, then the rating plate that shows the gas type of the unit must also be changed.

4 Preparation

Tips for saving energy

The following information will help you to use your appliance in an ecological way, and to save energy:

- Defrost frozen dishes before cooking them.
- Use pots/pans with cover for cooking. If there is no cover, energy consumption may increase 4 times.
- Select the burner which is suitable for the bottom size of the pot to be used. Always select the correct pot size for your dishes. Larger pots require more energy.

Initial use

First cleaning of the appliance



The surface might get damaged by some detergents or cleaning materials.

Do not use aggressive detergents, cleaning powders/creams or any sharp objects during cleaning.

Do not use harsh abrasive cleaners or sharp metal scrapers to clean the oven door glass since they can scratch the surface, which may result in shattering of the glass.

1. Remove all packaging materials.
2. Wipe the surfaces of the appliance with a damp cloth or sponge and dry with a cloth.

5 How to use the hob

General information about cooking



Never fill the pan with oil more than one third of it. Do not leave the hob unattended when heating oil. Overheated oils bring risk of fire. **Never attempt to extinguish a possible fire with water!** When oil catches fire, cover it with a fire blanket or damp cloth. Turn off the hob if it is safe to do so and call the fire department.

- Before frying foods, always dry them well and gently place into the hot oil. Ensure complete thawing of frozen foods before frying.
- Do not cover the vessel you use when heating oil.
- Place the pans and saucepans in a manner so that their handles are not over the hob to prevent heating of the handles. Do not place unbalanced and easily tilting vessels on the hob.
- Do not place empty vessels and saucepans on cooking zones that are switched on. They might get damaged.
- Operating a cooking zone without a vessel or saucepan on it will cause damage to the product. Turn off the cooking zones after the cooking is complete.
- As the surface of the product can be hot, do not put plastic and aluminum vessels on it. Such vessels should not be used to keep foods either.
- Use flat bottomed saucepans or vessels only.
- Put appropriate amount of food in saucepans and pans. Thus, you will not have to make any unnecessary cleaning by preventing the dishes from overflowing.

Do not put covers of saucepans or pans on cooking zones.

Place the saucepans in a manner so that they are centered on the cooking zone. When you want to move the saucepan onto another cooking zone, lift and place it onto the cooking zone you want instead of sliding it.

Gas cooking

- Size of the vessel and the flame must match each other. Adjust the gas flames so that they will not extend the bottom of the vessel and center the vessel on saucepan carrier.

Using the hobs

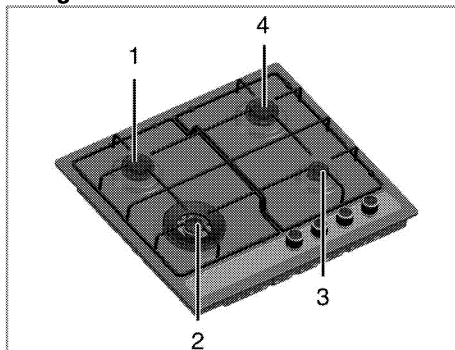

List of advised diameter of pots to be used on related burners

- 1 Normal burner 14-20 cm
- 2 Wok burner 22-30 cm
- 3 Auxiliary burner 12-18 cm
- 4 Normal burner 14-20 cm

Large flame symbol indicates the highest cooking power and small flame symbol indicates the lowest cooking symbol. In turned off position (top), gas is not supplied to the burners.

Igniting the gas burners

1. Keep burner knob pressed.
2. Turn it counter clockwise to large flame symbol.
» Gas is ignited with the spark created.
3. Adjust it to the desired cooking power.

Turning off the gas burners

Turn the keep warm zone knob to off (upper) position.

Gas shut off safety system (in models with thermic component)

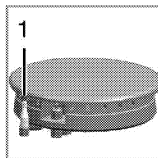

1. Gas shut off safety

As a counter measure against blow out due to fluid overflows at burners, safety mechanism trips and shuts off the gas.

- Push the knob inwards and turn it counter clockwise to ignite.
- After the gas ignites, keep the knob pressed for 3-5 seconds more to engage the safety system.

- If the gas does not ignite after you press and release the knob, repeat the same procedure by keeping the knob pressed for 15 seconds.

	<p>DANGER: Release the button if the burner is not ignited within 15 seconds. Wait at least 1 minute before trying again. There is the risk of gas accumulation and explosion!</p>
--	---

Wok burner

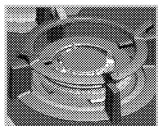

Wok burners help you to cook faster. Wok, which is particularly used in Asian kitchen is a kind of deep and flat fry-pan made of sheet metal, which is used to cook minced vegetable and meat at strong flame in a short time.

Since meals are cooked at strong flame and in a very short time in such fry-pans that conduct the heat rapidly and evenly, the nutrition value of the food is preserved and vegetables remain crispy.

You can use wok burner for regular saucepans as well.

6 Maintenance and care

General information

Service life of the product will extend and the possibility of problems will decrease if the product is cleaned at regular intervals.

**DANGER:**

Disconnect the product from mains supply before starting maintenance and cleaning works.

There is the risk of electric shock!

**DANGER:**

Allow the product to cool down before you clean it.

Hot surfaces may cause burns!

- Clean the product thoroughly after each use. In this way it will be possible to remove cooking residues more easily, thus avoiding these from burning the next time the appliance is used.
- No special cleaning agents are required for cleaning the product. Use warm water with washing liquid, a soft cloth or sponge to clean the product and wipe it with a dry cloth.
- Always ensure any excess liquid is thoroughly wiped off after cleaning and any spillage is immediately wiped dry.
- Do not use cleaning agents that contain acid or chloride to clean the stainless or inox surfaces and the handle. Use a soft cloth with a liquid detergent (not abrasive) to wipe those parts clean, paying attention to sweep in one direction.



The surface might get damaged by some detergents or cleaning materials.

Do not use aggressive detergents, cleaning powders/creams or any sharp objects during cleaning.

Do not use harsh abrasive cleaners or sharp metal scrapers to clean the oven door glass since they can scratch the surface, which may result in shattering of the glass.



Do not use steam cleaners to clean the appliance as this may cause an electric shock.

Cleaning the hob

Gas hobs

1. Remove and clean the saucepan carriers and burner caps.
2. Clean the hob.

3. Install the burner caps and make sure that they are seated correctly.
4. When installing the upper grills, pay attention to place the saucepan carriers so that the burners are centered.

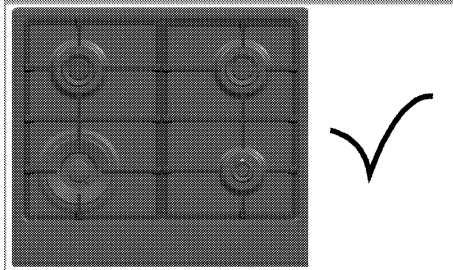
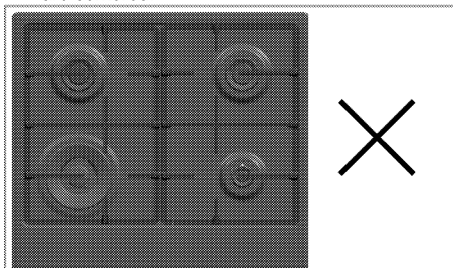

Cleaning the control panel

Clean the control panel and knobs with a damp cloth and wipe them dry.



Do not remove the control buttons/knobs to clean the control panel.

Control panel may get damaged!

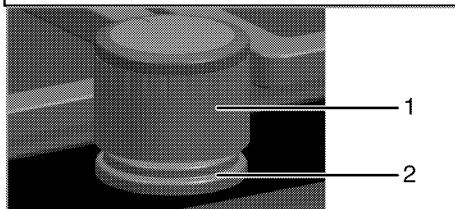

- 1 Knob
- 2 Sealing element



Do not remove the sealing elements under the knobs for cleaning.

7 Troubleshooting

Product emits metal noises while heating and cooling.

- When the metal parts are heated, they may expand and cause noise. >>> *This is not a fault.*

There is no ignition spark.

- No current. >>> *Check fuses in the fuse box.*

There is no gas.

- Main gas valve is closed. >>> *Open gas valve.*
- Gas pipe is bent. >>> *Install gas pipe properly.*

Burners are not burning properly or at all.

- Burners are dirty. >>> *Clean burner components.*
- Burners are wet. >>> *Dry the burner components.*
- Burner cap is not mounted safely. >>> *Mount the burner cap properly.*
- Gas valve is closed. >>> *Open gas valve.*
- Gas cylinder is empty (when using LPG). >>> *Replace gas cylinder.*



Consult the Authorised Service Agent or technician with licence or the dealer where you have purchased the product if you can not remedy the trouble although you have implemented the instructions in this section. Never attempt to repair a defective product yourself.

8 Guarantee Details

Your new Beko product is guaranteed against faulty materials, defective components or manufacturing defects. The guarantee starts from the date of original purchase of the product for a period of twelve (12) months unless Beko plc (the "Manufacturer") agrees to extend the guarantee for the product in writing. If you have any questions about the guarantee on your product (including how long it is valid), please contact your retailer or our Call Centre on 0333 207 9710.

This guarantee does not in any way diminish or affect your statutory rights in connection with the product. This guarantee is in addition to your statutory rights as a consumer. If you have any questions about these rights, please contact the retailer from which you purchased the product. In certain circumstances, it is possible that your statutory rights may offer additional or higher levels of protection than those offered under the terms of this guarantee.

What is covered by this guarantee?

- Repairs to the product required as a result of faulty materials, defective components or manufacturing defects.
- Functional replacement parts to repair a product.
- The costs of a Beko Approved Engineer to carry out the repair.

What is not covered?

- Transit and delivery damage.
- Cabinet or appearance parts, including but not limited to control knobs, flaps and handles.
- Accessories and/or consumable items including but not limited to ice trays, scrapers, cutlery baskets, filters and light bulbs.
- Repairs necessary as a direct or indirect result of:
 - Accidental damage, misuse or abuse of a product.
 - An attempted repair of a product by anyone other than a Beko authorised repairer.
 - Installation or use of a product where such installation or use fails to meet the requirements contained in this guarantee or the User Instructions Booklet.
- Repairs to a product operated at any time on commercial or non-residential household premises (unless we have previously agreed to the installation environment).

This guarantee is limited to the cost of repairing the product. To the extent permitted by law, the Manufacturer does not accept and will not be held liable for any financial loss incurred in connection with the failure of any product to operate in accordance with the expected standards. Such financial loss includes but is not limited to loss arising from:

- Time taken off work.
- Damaged food, clothing or other items.
- Meals taken at restaurants or from takeaways.
- General compensation for inconvenience.

Important Notes

- Your product is designed and built for domestic household use only.
- The guarantee will automatically be void if the product is installed or is used in commercial or non-residential domestic household premises, unless we have previously agreed to the installation environment.
- The product must be correctly installed, located and operated in accordance with the instructions contained in the User Instructions Booklet provided with your product.
- Professional installation by a qualified Electrical Domestic Appliance Installer is recommended for all Washing Machines, Dishwashers and Electric Cookers (as incorrect installation may result in you having to pay for the cost of repairing the product).
- Gas Cookers must be professionally installed by a Gas Safe (or Gas Networks Ireland for Republic of Ireland) registered gas installer.

- This guarantee is given in respect of products purchased and used within the United Kingdom and the Republic of Ireland.
- This guarantee is effective from the initial date of purchase of a new product from an authorised retailer and will be void if the product is resold.
- This guarantee does not apply to graded sales (where the product is purchased as a “second”).
- Possession of a copy of these terms and conditions does not necessarily mean that a product has the benefit of this guarantee. If you have any questions, please call our Call Centre on the number set out above.
- The Manufacturer reserves the right to terminate the guarantee if its staff or representatives are subjected to physical or verbal abuse in the course of carrying out their duties.
- Optional extras, where available (i.e. extendable feet) are supplied on a chargeable basis only.

Does Beko offer replacements?

This is a repair-only guarantee. On occasion, the Manufacturer may at its sole discretion, replace your product with a new product instead of carrying out a repair. Where a replacement is offered, this would normally be an identical model but when this is not possible, a model of similar specification will be provided. The Manufacturer will cover the costs and arrange for the delivery of the new product and for the return of the old product. Any costs related to disconnecting the faulty product and installing the replacement product will not be borne by the Manufacturer unless previously agreed to in writing. The original guarantee will continue to apply to the replacement product; the new product will not come with a new guarantee.

When will the repair take place?

Our Engineers work Monday to Friday 9.00am to 5.00pm. Appointments outside these hours may be possible at the sole discretion of the Manufacturer but cannot be guaranteed. Whilst our Engineers will endeavour to minimize inconvenience and to meet requests for specific timed appointments, this cannot be guaranteed. We will not be liable for delays or if it is unable to carry out a repair because a convenient appointment cannot be arranged.

Will there be any charge for the repairs?

It is your responsibility to provide evidence to the Engineer that your product is covered by this guarantee with a proof of purchase. The Manufacturer reserves the right to charge for the reasonable cost of any service call if:

- You cannot provide evidence that your product is covered by this guarantee.
- Where a service call has been made and the engineer finds that there is no fault with your product.
- That your product has not been installed or operated in accordance with the User Instructions Booklet.
- That the fault was caused by something other than faulty materials, defective components or manufacturing defects.
- For missed appointments.

Payment of these costs are due immediately upon the Engineer providing you with an invoice. The Manufacturer reserves the right to terminate the guarantee if you fail to pay the costs for the service call in a timely manner.

If you are a resident of the United Kingdom, this guarantee will be governed by English law and subject to the English Courts, save where you live in another part of the United Kingdom, in which case the law and courts of that location will apply.

If you are resident in the Republic of Ireland, this guarantee will be governed by Irish law and the Irish courts will have jurisdiction.

HOW TO OBTAIN SERVICE

Please keep your purchase receipt or other proof of purchase in a safe place; you will need to have it should the product require attention under guarantee.

It will be useful if you complete the details below, as it will help us assist you when requesting service (the model number is printed on the Instruction Booklet and the serial number is printed on the Rating Label affixed to the appliance). Recording of these details alone will not count as proof of purchase. A valid proof of purchase is required for under guarantee service.

The area around the product must be easily accessible to the Engineer without the need for cabinets or furniture being removed.

It is your responsibility to ensure our Engineers have a clean and safe environment to carry out any repairs.

.....
Model No:

Serial No:

Retailer:

Date of purchase:
.....

For service under guarantee simply telephone the appropriate number below:

UK Mainland & Northern Ireland: 0333 207 9710 or customerservice@support.Beko.co.uk

Republic of Ireland: 01 862 3411 or customerservice@support.Beko.ie

Register your appliance: For UK registrations visit beko.co.uk/register and for the Republic of Ireland beko.ie/register.

Before requesting service please check the troubleshooting guide in the Operating Instructions as a charge may be levied where no fault is found even though your product may still be under guarantee.

Service once the manufacturers guarantee has expired

If you have purchased an extended guarantee please refer to the instructions contained within the extended guarantee agreement document, otherwise please call the appropriate number above where service can be obtained at a charge.

Should you experience any difficulty in obtaining service contact the Beko Customer Helpline on Tel: 0333 207 9710 or e-mail: CustomerService@support.beko.co.uk
.....

This guarantee is provided by Beko plc. Beko House, 1 Greenhill Crescent, Watford, Herts, WD18 8QU. Beko plc is registered in England and Wales with company registration number 02415578.

