

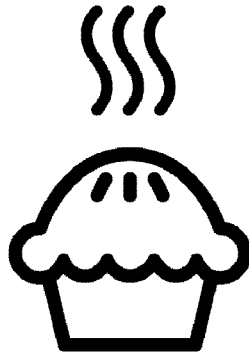

Double Cavity
User Manual



KDG580W

EN

485.3023.54/R.AA/18.10.2022

7787586342



RECYCLED &
RECYCLABLE PAPER

Please read these instructions first before using your appliance

Thank you for choosing a Beko appliance.

Please take some time to read this user manual before using your appliance, to ensure you know how to safely operate the controls and functions.

Carefully follow all unpacking and installation instructions to ensure the appliance is correctly connected and fitted prior to use.

Please write your product model and serial number on the last page of this user manual, and store in a safe location close to the appliance for easy future reference.

This user manual may also be applicable for several other models. Differences between models will be listed.

If you have any questions or concerns, please call our contact centre or find help and information online at www.beko.co.uk

Explanation of symbols used throughout this User Manual



Important information or useful hints about usage.



Warning of hazardous situations with regard to life and property.



Warning of electric shock.



Warning of risk of fire.



Warning of hot surfaces.

TABLE OF CONTENTS

1 Important instructions and warnings for safety and environment 4

Intended use	4
General safety	4
Safety when working with gas.....	5
Electrical safety	6
Product safety	7
Safety for children.....	9
Disposing of the old product.....	10
Package information	10
Future Transportation.....	10

2 General information 11

Overview	11
Package contents	12
Technical specifications	13
Injector table	13

3 Installation 14

Before installation	14
Installation and connection	15
Gas conversion.....	19

4 Preparation 24

Tips for saving energy	24
Initial use.....	24
First cleaning of the appliance	24
Initial heating.....	24

5 How to use the hob 25

General information about cooking	25
Using the hobs.....	25

6 How to operate the oven 27

General information on baking, roasting and grilling.....	27
How to use the gas oven.....	27
Cooking times table.....	28
How to operate the gas grill	29
Cooking times table.....	30

7 Maintenance and care 31

General information.....	31
Cleaning the hob	31
Cleaning the control panel	31
Cleaning the oven	31
Removing the top oven door.....	32
Removing the door inner glass	32

8 Troubleshooting 34

9 Guarantee Details 35

1 Important instructions and warnings for safety and environment

This section contains safety instructions that will help protect from risk of personal injury or property damage. Failure to follow these instructions shall void any warranty.

Intended use

CAUTION

- This appliance is designed for cooking food (baking, roasting, grilling of food and defrosting) and is intended for indoor domestic household and static home use only.
- This appliance should not be used for any other purpose or in any other application, such as for non-domestic use or in a commercial environment.
- In addition this appliance is not suitable for use on any type of boat (offshore, inland waterway, canal boat or houseboat), caravans or motor homes. Installation in static caravans and mobile homes is permitted.
- Incorrect installation environments will void the guarantee.
- This appliance should not be used for warming plates under the grill, drying towels, dish cloths etc. by hanging them on the oven door

handles or for room heating purposes.

- The manufacturer shall not be liable for any damage caused by improper use or handling.

General safety

- This appliance can be used by children aged from 8 years and above and persons with reduced physical, sensory or mental capabilities or lack of experience and knowledge if they have been given supervision or instruction concerning use of the appliance in a safe way and understand the hazards involved.
Children shall not play with the appliance. Cleaning and user maintenance shall not be made by children without supervision.
- The appliance is not to be used by persons (including children) with reduced physical, sensory or mental capabilities, or lack of experience and knowledge, unless they have been given supervision or instruction. Children should be supervised and ensure they do not play with the appliance
- If the product is handed over to someone else for personal use or second-hand use purposes, the

user manual, product labels and other relevant documents and parts should be also given.

- Never place the product on a carpet-covered floor. Otherwise, lack of airflow beneath the product will cause electrical parts to overheat. This will cause problems with your product.
- Installation and repair procedures must always be performed by Authorized Service Agents. The manufacturer shall not be held responsible for damages arising from procedures carried out by unauthorized persons which may also void the warranty. Before installation, read the instructions carefully.
- Do not operate the product if it is defective or has any visible damage.
- Ensure that the product function knobs are switched off after every use.

Safety when working with gas

- Any works on gas equipment and systems may only be carried out by authorised qualified persons who are Gas Safe registered.
- Prior to the installation, ensure that the local distribution conditions (nature of the gas and gas pressure) and the adjustment of the appliance are compatible.

- This appliance is not connected to a combustion products or evacuation device. It shall be installed and connected in accordance with current installation regulations. Particular attention shall be given to the relevant requirements regarding ventilation; See *Before installation, page 14*
- The use of gas cooking appliance results in the production of heat and moisture in the room in which it is installed. Ensure that the kitchen is well ventilated: keep natural ventilation holes open or install a mechanical ventilation device (mechanical extractor hood). Prolonged intensive use of the appliance may call for additional ventilation, for example increasing the level of the mechanical ventilation where present.
- Gas appliances and systems must be regularly checked for proper functioning. Regulator, hose and its clamp must be checked regularly and replaced within the periods recommended by its manufacturer or when necessary.
- Clean the gas burners regularly. The flames should be blue and burn evenly.
- This product should be used in a room which incorporates a

properly adjusted and functioning Carbon Monoxide sensor. Make sure the Carbon Monoxide sensor works properly and is maintained frequently. Carbon Monoxide sensor should be installed maximum 2 meters away from the product.

- Good combustion is required in gas appliances. In case of incomplete combustion, carbon monoxide (CO) might develop. Carbon monoxide is a colourless, odourless and very toxic gas, which has a lethal effect even in very small doses.
- Request information about gas emergency telephone numbers and safety measures in case of gas smell from you local gas provider.

What to do when you smell gas

- Do not use open flame or do not smoke. Do not operate any electrical buttons (e.g. lamp button, door bell and etc.) Do not use fixed or mobile phones. Risk of explosion and toxication!
- Open doors and windows.
- Turn off all valves on gas appliances and gas meter at the main control valve, unless it's in a confined space or cellar.
- Check all tubes and connections for tightness. If you still smell gas leave the property.

- Warn the neighbours.
- Call the fire-brigade. Use a telephone outside the house.
- Call the Gas Emergency Services immediately on 0800 111 999. If you have door or gates that are secured by an electric lock, or entry phone, please open these manually.
- Do not re-enter the property until you are told it is safe to do so.

Electrical safety

- If the product has a failure, it should not be operated unless it is repaired by an Authorized Service Agent. There is the risk of electric shock!
- Only connect the product to a grounded outlet/line with the voltage and protection as specified in the “Technical specifications”. Have the grounding installation made by a qualified electrician while using the product with or without a transformer. Our company shall not be liable for any problems arising due to the product not being earthed in accordance with the local regulations.
- Never wash the product by spreading or pouring water onto it! There is the risk of electric shock!
- Never touch the plug with wet hands! Never unplug by pulling on

the cable, always pull out by holding the plug.

- The product must be disconnected during installation, maintenance, cleaning and repairing procedures.
- If the power connection cable for the product is damaged, it must be replaced by the manufacturer, its service agent or similarly qualified persons in order to avoid a hazard.
- The appliance must be installed so that it can be completely disconnected from the mains supply. The separation must be provided by a switch built into the fixed electrical installation, according to construction regulations.
- Rear surface of the oven gets hot when it is in use. Make sure that the gas/electrical connection does not contact the rear surface; otherwise, connections can get damaged.
- Do not trap the mains cable between the oven door and frame and do not route it over hot surfaces. Otherwise, cable insulation may melt and cause fire as a result of short circuit.
- Any work on electrical equipment and systems should only be carried out by authorized and qualified persons.

- In case of any damage, switch off the product and disconnect it from the mains. To do this, turn off the fuse at home.
- Make sure that fuse rating is compatible with the product.

Product safety

- **WARNING:** The appliance and its accessible parts become hot during use. Care should be taken to avoid touching heating elements. Children less than 8 years of age shall be kept away unless continuously supervised.
- Never use the product when your judgment or coordination is impaired by the use of alcohol and/or drugs.
- Be careful when using alcoholic drinks in your dishes. Alcohol evaporates at high temperatures and may cause fire since it can ignite when it comes into contact with hot surfaces.
- **Food Poisoning Hazard:** Do not let food sit in oven for more than 1 hour before or after cooking. Doing so can result in food poisoning or sickness.
- Do not place any flammable materials close to the product as the sides may become hot during use.
- During use the appliances becomes hot. Care should be

taken to avoid touching heating elements inside the oven.

- Keep all ventilation slots clear of obstructions.
- Do not heat closed tins and glass jars in the oven. The pressure that would build-up in the tin/jar may cause it to burst.
- Do not place baking trays, dishes or aluminium foil directly onto the bottom of the oven. The heat accumulation might damage the bottom of the oven.
- Do not use harsh abrasive cleaners or sharp metal scrapers to clean the oven door glass since they can scratch the surface, which may result in shattering of the glass.
- Do not use steam cleaners to clean the appliance as this may cause an electric shock.
- (Varies depending on the product model.)

Placing the wire shelf and tray onto the wire racks properly
It is important to place the wire shelf and/or tray onto the rack properly. Slide the wire shelf or tray between 2 rails and make sure that it is balanced before placing food on it (Please see the following figure).

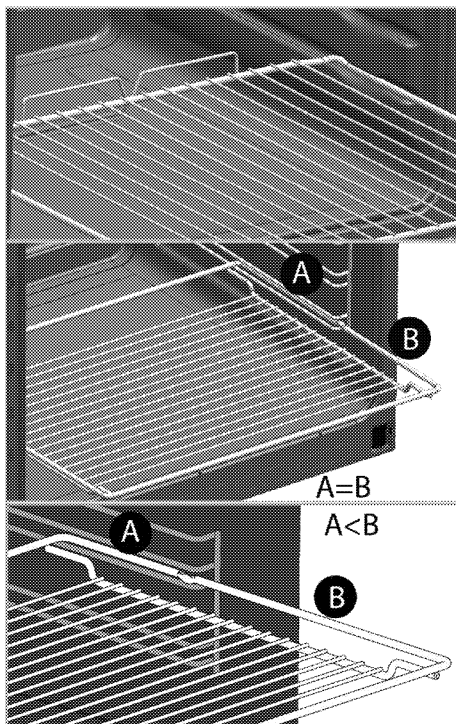

Do not use the product if the front door glass removed or cracked.

- Do not use the oven handle to hang towels for drying. Do not hang up towel, gloves, or similar textile products when the grill function is at open door.
- Always use heat resistant oven gloves when putting in or removing dishes into/from the hot oven.
- Place the baking paper into the cooking pot or on to the oven accessory (tray, wire grill etc) together with the food and then insert all into the preheated oven. Remove the excess parts of the baking paper overflowing from the

accessory or the pot in order to prevent the risk of touching the oven's heating elements. Never use the baking paper in an operating temperature higher than the indicated value for the baking paper. Do not place the baking paper directly on the base of the oven.

- The appliance must not be installed behind a decorative door in order to avoid overheating.
- Product must be placed directly on the floor. It must not be placed onto a base or a pedestal.
- **WARNING:** Unattended cooking on a hob with fat or oil can be dangerous and may result in fire. NEVER try to extinguish a fire with water, but switch off the appliance and then cover flame e.g. with a lid or a fire blanket.
- **CAUTION:** The cooking process has to be supervised. A short term cooking process has to be supervised continuously.
- **WARNING:** Danger of fire: Do not store items on the cooking surfaces.

Prevention against possible fire risk!

- Ensure all electrical connections are secure and tight to prevent risk of arcing.
- Do not use damaged cables or extension cables.

- Ensure liquid or moisture is not accessible to the electrical connection point.
- To prevent gas leakage ensure that the gas connection is sound.

Safety for children

- **WARNING:** Accessible parts may become hot during use. Young children should be kept away.
- The packaging materials will be dangerous for children. Keep the packaging materials away from children. Please dispose of all parts of the packaging according to environmental standards.
- Electrical and/or gas products are dangerous to children. Keep children away from the product when it is operating and do not allow them to play with the product.
- An additional protective means to avoid contact with the oven door is available. This part should be fitted when young children are likely to be present.
- Do not place any items above the appliance that children may reach for.
- When the door is open, do not load any heavy object on it and do not allow children to sit on it. It may overturn or door hinges may get damaged.

Disposing of the old product

Compliance with the WEEE Directive and Disposing of the Waste Product:



This product complies with EU WEEE Directive (2012/19/EU). This product bears a classification symbol for waste electrical and electronic equipment (WEEE).

This product has been manufactured with high quality parts and materials which can be reused and are suitable for recycling. Do not dispose of the waste product with normal domestic and other wastes at the end of its service life. Take it to the collection center for the recycling of electrical and electronic equipment. Please consult your local authorities to learn about these collection centers.

Compliance with RoHS Directive:

The product you have purchased complies with EU RoHS Directive (2011/65/EU). It does not contain harmful and prohibited materials specified in the Directive.

Package information

- Packaging materials of the product are manufactured from recyclable materials in accordance with our National Environment Regulations. Do not dispose of the packaging materials together with the domestic or other wastes. Take them to the packaging material collection points designated by the local authorities.

Future Transportation

- Keep the product's original carton and transport the product in it. Follow the instructions on the carton. If you do not have the original carton, pack the product in bubble wrap or thick cardboard and tape it securely.
- To prevent the wire grill and tray inside the oven from damaging the oven door, place a strip of cardboard onto the inside of the oven door that lines up with the position of the trays. Tape the oven door to the side walls.
- Secure the caps and pan supports with adhesive tape.

- Do not use the door or handle to lift or move the product.



Do not place any objects onto the product and move it in upright position.



Check the general appearance of your product for any damages that might have occurred during transportation.

2 General information

Overview

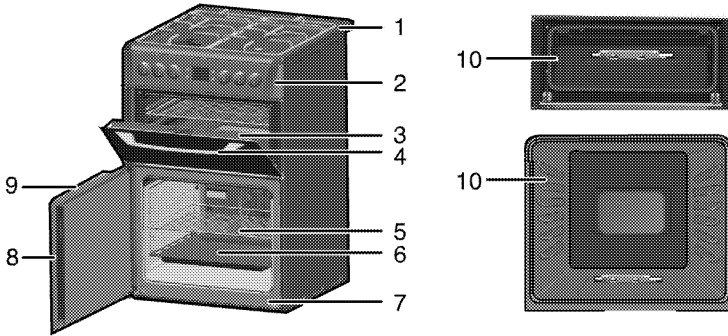

- | | | | |
|---|---------------|----|-----------------|
| 1 | Burner plate | 6 | Tray |
| 2 | Control panel | 7 | Rating plate |
| 3 | Top oven door | 8 | Main oven door |
| 4 | Handle | 9 | Handle |
| 5 | Wire shelf | 10 | Shelf positions |

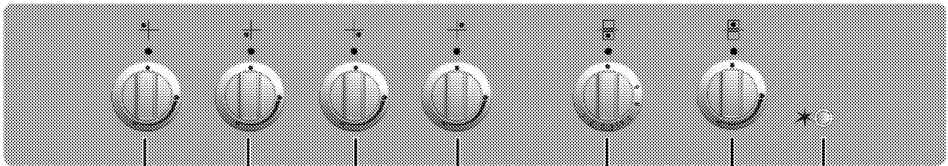

- | | | | |
|---|------------------------------|---|---------------------------|
| 1 | Normal burner Rear left | 5 | Main oven thermostat knob |
| 2 | Rapid burner Front left | 6 | Top oven thermostat knob |
| 3 | Auxiliary burner Front right | 7 | Ignition button |
| 4 | Normal burner Rear right | | |

Package contents



Accessories supplied can vary depending on the product model. Not every accessory described in the user manual may exist on your product.

1. **User manual**
2. **Small oven tray**

Used for small portions. This oven tray is placed onto the wire shelf.

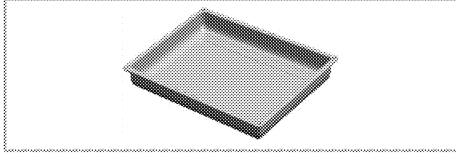

3. **Wire Shelf**

Used for roasting and for placing the food to be baked, roasted or cooked in casserole dishes to the desired rack.

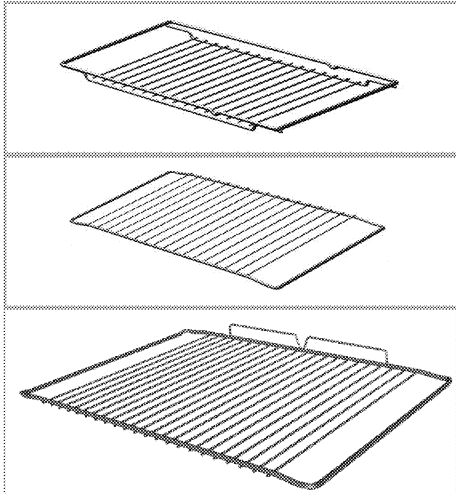

4. **Small wire shelf**

It is placed into the tray (if supplied) in order to collect the dripping fat while grilling so that the oven is kept clean.

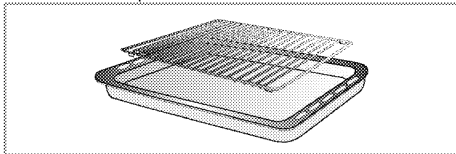

5. **Placing the wire shelf and tray onto the telescopic racks properly**
(This feature is optional. It may not exist on your product.)

Telescopic racks allow you to install and remove the trays and wire shelf easily.

When using the tray and wire shelf with telescopic racks, make sure that the pins at the rear section of the telescopic rack stands against the edges of the wire shelf and tray.

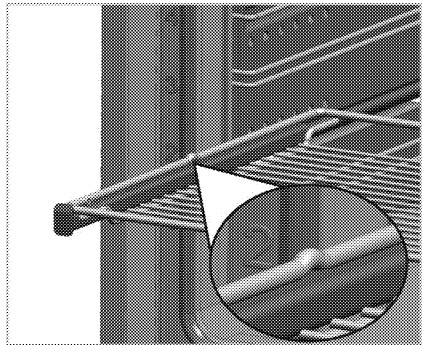
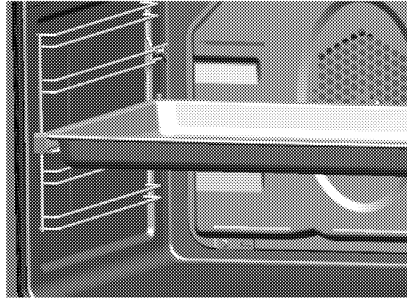

6. **Wire shelf shield metal**

Can be used for roasting and as deposit for baking, roasting and casserole dishes. In order to get best cooking performance it should be used together with the wire shelf shield metal on the rear side.

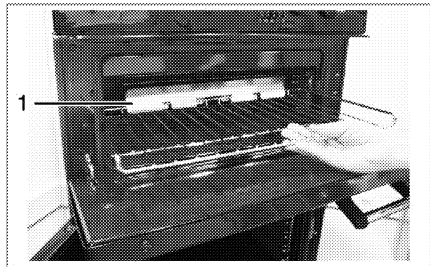

1. **Metal shield**

Metal shield should be attached on the rear-upper side of wire shelf. Use the wire shelf as its bended side positioned on the front of the cavity and turned downside.

Technical specifications

GENERAL	
External dimensions (height / width / depth)	900 mm/500 mm/600 mm
Voltage / frequency	220-240 V ~ 50 Hz
Fuse	min. 13 A
Cable type / section	min.H05VV-FG 3 x 0,75 mm ² or equivalent
Category of gas product	II 2H3+
Gas type / pressure	NG G 20/20 mbar
Total gas consumption	12,5 kW
Converting the gas type / pressure ⁹	LPG G 30/28-30 mbar
– optional	Propane 31/37 mbar

HOB

Burners

Rear left	Normal burner
Power	2 kW
Front left	Rapid burner
Power	2.9 kW
Front right	Auxiliary burner
Power	1 kW
Rear right	Normal burner
Power	2 kW

OVEN/GRILL

Top oven	Grill oven
Grill power consumption	2.1 kW
Main oven	Gas oven
Gas consumption of oven	2.5 kW



Technical specifications may be changed without prior notice to improve the quality of the product.



Figures in this manual are schematic and may not exactly match your product.



Values stated on the product labels or in the documentation accompanying it are obtained in laboratory conditions in accordance with relevant standards. Depending on operational and environmental conditions of the product, these values may vary.

Injector table

Position hob zone	2000 W Rear left	2900 W Front left	1000 W Front right	2000 W Rear right
Gas type / Gas pressure				
G 20/20 mbar	103	115	72	103
G 30/28-30 mbar/ G 31/ 37 mbar	72	87	50	72
Gas type / Gas pressure-Top Cavity	Grill			
G 20/20 mbar				105
G 30/28-30 mbar/ G 31/ 37 mbar				71
Gas type / Gas pressure-Main OVEN	Gas oven			
G 20/20 mbar				115
G 30/28-30 mbar / G 31/ 37 mbar				78

3 Installation

Product must be installed by a qualified person in accordance with the regulations in force. The manufacturer shall not be held responsible for damages arising from procedures carried out by unauthorized persons which may also void the warranty.



Preparation of location and electrical and gas installation for the product is under the installer's responsibility.



DANGER:

The product must be installed in accordance with all local gas and/or electrical regulations.



DANGER:

Prior to installation, visually check if the product has any defects on it. If so, do not have it installed.

Damaged products cause risks for your safety.

Before installation

To ensure that critical air gaps are maintained under the appliance, we recommend that this appliance is mounted on a solid base and that the feet do not sink into any carpet or soft flooring.

The kitchen floor must be able to carry the weight of the appliance plus the additional weight of cookware and bakeware and food.

If the range is placed on a base, measures have to be taken to prevent the appliance slipping from the base.

The appliances must not be installed behind a decorative door in order to avoid overheating.

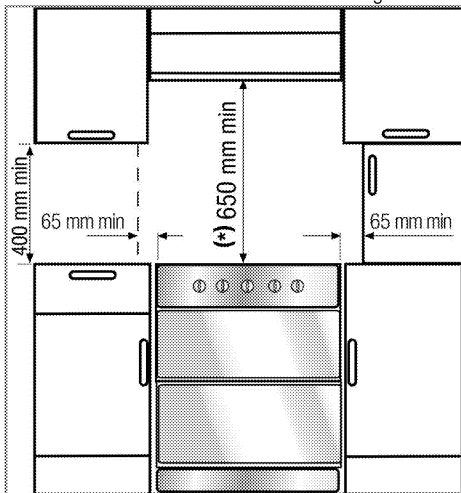

- It can be used with cabinets on either side but in order to have a minimum distance of 400mm above hotplate level allow a side clearance of 65mm between the appliance and any wall, partition or tall cupboard.
- It can also be used in a free standing position. Allow a minimum distance of 650 mm above the hob surface.
- (*) If a cooker hood is to be installed above the cooker, refer to cooker hood manufacturer's instructions regarding installation height (min 650 mm).
- Movement of your appliance is most easily achieved by lifting the front as follows and pulling towards. Open the top oven door and the bottom oven door sufficiently to allow a comfortable grip on the underside front edge of the oven roofs. While gripping, it should be avoided to damage any grill elements or oven interior furniture.
- The appliance corresponds to device class 1, i.e. it may be placed with the rear and **one** side to kitchen walls, kitchen furniture or equipment of any size. The kitchen furniture or equipment on the **other** side may only be of the same size or smaller.
- Any kitchen furniture next to the appliance must be heat-resistant (100 °C min.).

Safety chain

If your product has 2 safety chains;

The appliance must be secured against overbalancing by using the supplied two safety chains on your oven. Fasten hook (1) by using a proper peg to the kitchen wall (6) and connect safety chain (3) to the hook via the locking mechanism (2).

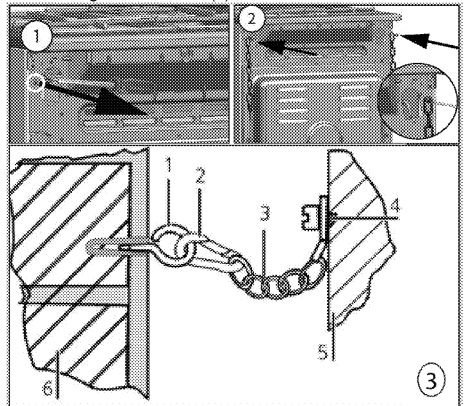

1 Stability hook

- 2 Locking mechanism
- 3 Safety chain (supplied and mounted to oven)
- 4 Firmly fix chain to cooker rear
- 5 Rear of cooker
- 6 Kitchen wall

If your product has 1 safety chain;

The appliance must be secured against overbalancing by using the supplied one safety chain on your oven. Follow below steps in the picture to secure the safety chain to your product.

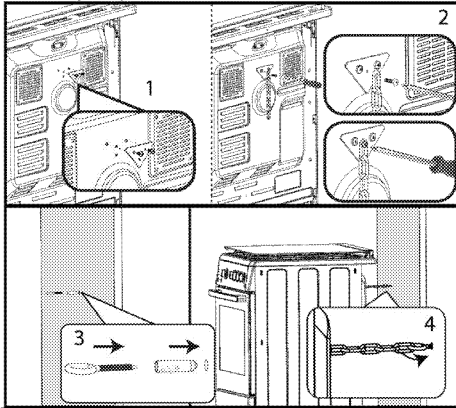

Stability chain to be as short as practicable to avoid oven tilting forward and diagonal to avoid oven side tilting.

- Cooker stability chain for cookers is not designed with bracket engagement slot.

Room ventilation

All rooms require an openable window, or equivalent, and some rooms will require a permanent vent as well. The air for combustion is taken from the room air and the exhaust gases are emitted directly into the room. Good ventilation is essential for safe operation of your appliance.

Rooms with doors and/or windows which open directly to the outer environment

The doors and/or windows that open directly to the outer environment must have a total ventilation opening of the dimensions specified in the table below which is based on the total gas power of the appliance (total gas power consumption of the appliance is shown in the technical specification table of this user manual). If the doors and/or windows do not have a total ventilation opening corresponding to the total gas consumption of the appliance as specified in the table below, then there must definitely be an additional fixed ventilation opening in the room to ensure that the total minimum ventilation requirements for the total gas consumption of the appliance is achieved. The fixed

ventilation opening can include openings for existing airbricks, extraction hood ducting opening dimension etc.

Total gas consumption (kW)	min. Ventilation opening (cm ²)
0-2	100
2-3	120
3-4	175
4-6	300
6-8	400
8-10	500
10-11.5	600
11.5-13	700
13-15.5	800
15.5-17	900
17-19	1000
19-24	1250

Rooms that do not have openable doors and/or windows that open directly to the outer environment

If the room where the appliance is installed does not have a door and/or a window that opens directly to the outer environment, other products shall be sought that definitely provide a fixed nonadjustable and non-closable ventilation opening which meets the total minimum ventilation opening requirements for the total gas consumption of the appliance as indicated in the above table. Also the appropriate building regulations advise should be followed.

Where a room or internal space contains more than one gas appliance, additional ventilation area shall be provided on top of the requirement given in the table above. Size of additional ventilation area shall be appropriate to regulations of other gas appliances. There should also be a minimum clearance of 10mm on the bottom edge of the door that opens to the inner environment in the room where the appliance is installed. You must ensure that items such as carpets and other floorcoverings etc., do not affect the clearance when the door is closed.

The cooker may be located in a kitchen, kitchen/diner or a bed-sitting room, but not in a room containing a bath or a shower. The cooker must not be installed in a bed-sitting room of less than 20m³.

Do not install this appliance in a room below ground level unless it is open to ground level on at least one side.

Installation and connection

CAUTION

- * This appliance is designed for cooking food (baking, roasting, grilling of food and defrosting)

and is intended for indoor domestic household and static home use only.

- This appliance should not be used for any other purpose or in any other application, such as for non-domestic use or in a commercial environment.
- In addition this appliance is not suitable for use on any type of boat (offshore, inland waterway, canal boat or houseboat), caravans or motor homes. Installation in static caravans and mobile homes is permitted.
- Incorrect installation environments will void the guarantee.
- This appliance should not be used for warming plates under the grill, drying towels, dish cloths etc. by hanging them on the oven door handles or for room heating purposes.
- The manufacturer shall not be liable for any damage caused by improper use or handling.

Product can only be installed and connected in accordance with the statutory installation rules.



Do not install the product next to refrigerators or freezers. The heat emitted by the product will increase the energy consumption of cooling appliances.

- Carry the product with at least two persons.
- Product must be placed directly on the floor. It must not be placed onto a base or a pedestal.



Do not use the door and/or handle to carry or move the product. The door, handle or hinges get damaged.

Electrical connection

Connect the product to a grounded outlet/line protected by a fuse of suitable capacity as stated in the "Technical specifications" table. Have the grounding installation made by a qualified electrician while using the product with or without a transformer. Our company shall not be liable for any damages that will arise due to using the product without a grounding installation in accordance with the local regulations.



DANGER:

The product must be connected to the mains supply only by an authorised and qualified person. Manufacturer shall not be held responsible for damages arising from procedures carried out by unauthorised persons.



DANGER:

The power cable must not be clamped, bent or trapped or come into contact with hot parts of the product.

A damaged power cable must be replaced by a qualified electrician. Otherwise, there is risk of electric shock, short circuit or fire!

The mains supply data must correspond to the data specified on the type label of the product. The rating plate is either seen when the door or the lower cover is opened or it is located at the rear wall of the unit depending on the unit type.

Power cable of your product must comply with the values in "Technical specifications" table.



Power cable plug must be within easy reach after installation (do not route it above the hob).

The moulded plug on this appliance incorporates a 13 A fuse. Should the fuse need to be replaced an ASTA approved BS1362 fuse of the same rating must be used. Do not forget to refit the fuse cover. In the event of losing the fuse cover, the plug must not be used until a replacement fuse cover has been fitted. Colour of the replacement fuse cover must be the same colour as that visible on the pin face of the plug. Fuse covers are available from any good electrical store.

- **Fitting a different plug**

As the colours of the wires in the mains lead of this appliance may not correspond with the coloured markings identifying the terminals on your plug, proceed as follows:

- Brown cable = L (Live)
- Blue cable = N (Neutral)
- Green/yellow cable must be connected to ground

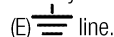
(E)  line.

With the alternative plugs a 13 A fuse must be fitted either in the plug or adaptor or in the main fuse box. If in doubt contact a qualified electrician.

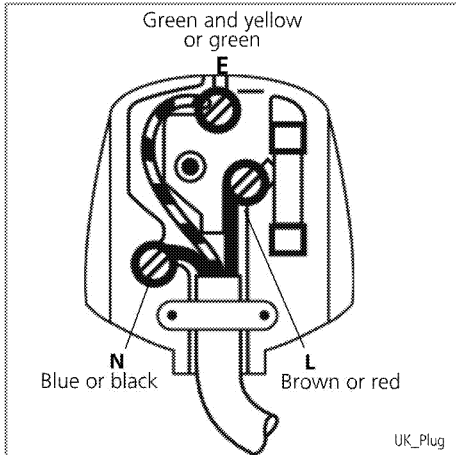

DANGER:
 Before starting any work on the electrical installation, disconnect the product from the mains supply.
 There is the risk of electric shock!

Connect the power cable into the socket.

Gas connection

DANGER:
 Product can be connected to gas supply system only by an authorised and qualified person or technician with licence.
 Risk of explosion or toxication due to unprofessional repairs!
 Manufacturer shall not be held responsible for damages arising from procedures carried out by unauthorised or unlicensed persons.

DANGER:
 Before starting any work on the gas installation, disconnect the gas supply.
 There is the risk of explosion!

- Gas adjustment conditions and values are stated on labels (or ion type label).
- In the UK, Gas Safe registered installers (Including the Regions of British Gas) undertake to work to safe and satisfactory standards.

Regulations

The cooker must be installed in accordance with the Gas Safety (Installation and Use) Regulations and the relevant Building Regulations in force.

i Your product is equipped for natural gas (NG).

The cooker is designed for UK installation using a flexible connection with tubing in accordance with the regulations in force. Length of 900mm is recommend.

Make sure that the natural gas valve is readily accessible.

Service Representative will remove the plug during connection and connect your appliance by means of a straight connection device (coupling).

If a flexible hose is used it must not come into contact with the top 150mm/6 inches (hot region) of the rear of the appliance. Do not pass the hose through the (**) hot region behind the oven.

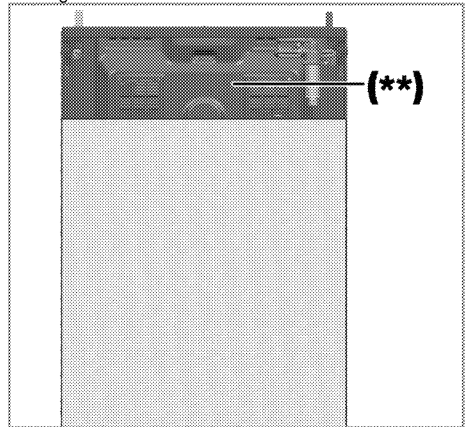

(**) Hot region

i If you need to use your appliance later with a different type of gas, you must consult an authorised service centre for the related conversion procedure.

If your product has only one gas outlet;

- Before connecting the gas hose, make sure that the gas hose outlet at the back of the product is on the same side of the product as the natural gas valve.

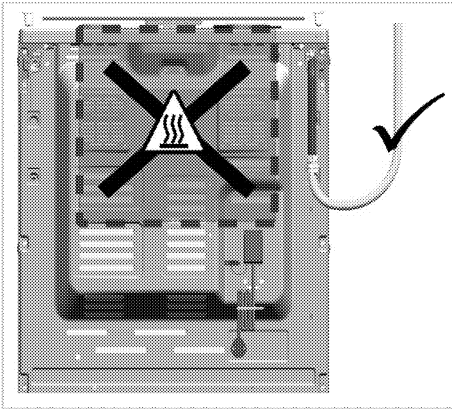

- If the gas hose outlet and the natural gas valve do not face the same side, make sure that the hose does not pass through the hot area when connecting it.

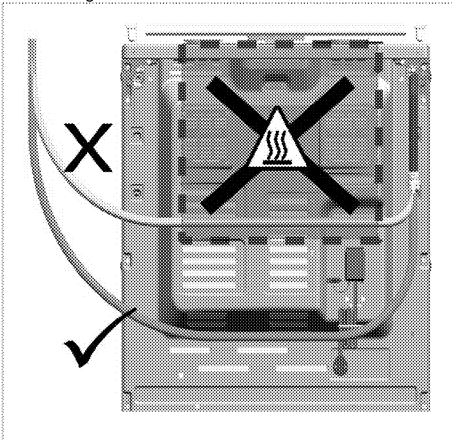

If your product has two gas outlets;

- One of the two outlets is sealed with a blind plug. The end of the other outlet is open.

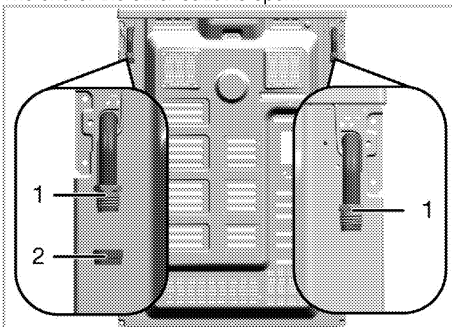

- 1 Gas hose outlet
- 2 Blind plug

(The outlet to which the blind plug is attached may vary depending on the product model.)

- Before gas connection, make sure that the natural gas valve and the gas hose outlet of the product to be connected to the gas is on the same side.
- If the natural gas valve and the open-ended gas hose outlet are on the same side, make the gas connection as shown in the figure below.

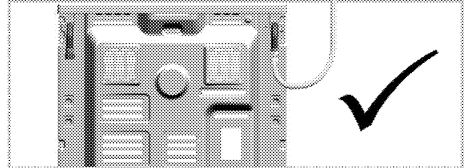

- If the natural gas valve and the gas hose outlet sealed with the blind plug face on the same side, remove the blind plug from the gas hose outlet using two wrenches. Close the gas hose outlet with this blind plug where gas connection will not be made with a new (unused) sealing gasket.

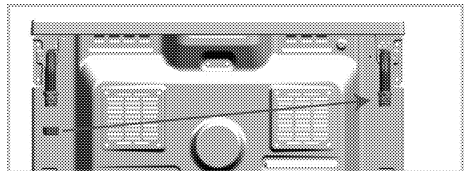

- Make the gas connection as shown in the figure below on the gas hose outlet near the natural gas valve.

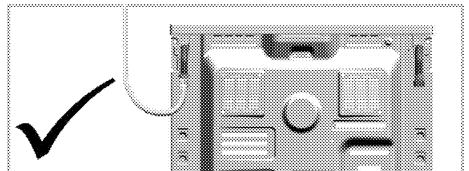

Seal all connections with gas sealant.

1. Shut gas supply.
2. Connect safety (gas) hose 3 to the inlet valve of the oven.
3. Connect gas hose with elbow joint 4.

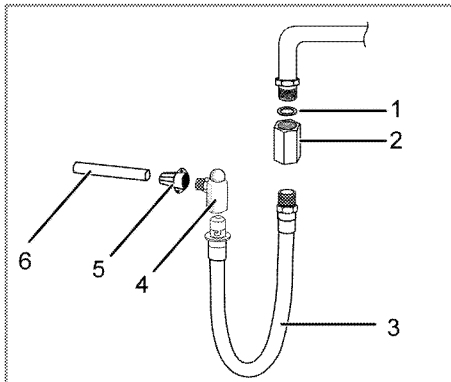



- 1 Gasket
- 2 Adapter (optional) with 1/2" outlet
- 3 Gas (safety) hose
- 4 Valve with 90° outlet
- 5 Connection piece
- 6 Gas supply pipe

Risk of fire:

If you do not make the connection according to the instructions below, there will be the risk of gas leakage and fire. **Our company cannot be held responsible for damages resulting from this.**

- Gas connection must be made by the authorised service provider only.
- The gas hose outlet that will not be used must be sealed with the blind plug.
- When closing the gas hose outlet that will not be used, you must definitely use a new and unused sealing gasket.

DANGER:

 The flexible gas hose must be connected in a way that it does not contact the moving parts around it and is not trapped when the moving parts are travelling. (e.g. drawers). Besides, it should not be placed in spaces where it might get squeezed.

DANGER:

 The flexible gas hose must be connected in a way that it does not contact the moving parts around it and is not trapped when the moving parts are travelling. (e.g. drawers). Besides, it should not be placed in spaces where it might get squeezed.

DANGER:

 The gas hose must not be clamped, bent or trapped or come into contact with hot parts of the product.
 There is the risk of explosion due to damaged gas hose.

Leakage check at the connection point

- Make sure that all knobs on the product are turned off. Make sure that the gas supply is open. Prepare soapy foam and apply it onto the connection point of the hose for gas leakage control.
- Soapy part will froth if there is a gas leakage. In this case, inspect the gas connection once again.
- **If your product has two gas hose outlets**, make sure that the unused gas outlet is sealed with a blind plug. Prepare soapy foam and apply it onto the connection point of the blind plug to check for gas leaks. Soapy part will froth if there is a gas leakage. In this case, inspect the blind plug connection again.
- Instead of soap, you can use commercially available sprays for gas leak check.

i Never use a match or lighter to make the gas leakage control.

- Push the product towards the kitchen wall.
- **Adjusting the feet of oven**
 Vibrations during use may cause cooking vessels to move. This dangerous situation can be avoided if the product is level and balanced. For your own safety please ensure the product is level by adjusting the four feet at the bottom by turning left or right and align level with the work top.

Final check

1. Open gas supply.
2. Check gas installations for secure fitting and tightness.
3. Ignite burners and check appearance of the flame.

i Flame must be blue and have a regular shape. If the flame is yellowish, check if the burner cap is seated securely or clean the burner.

Gas conversion

DANGER:

 Before starting any work on the gas installation, disconnect the gas supply.
 There is the risk of explosion!

In order to change your appliance's gas type, change all injectors and make flame adjustment for all valves at reduced flow rate position.

- **Gas conversion must only be carried out by a Gas Safe registered installer or service agent.**

Exchange of injector for the burners

1. Take off burner cap and burner body.
2. Unscrew injectors by turning the counter-clockwise.
3. Fit new injectors.
4. Check all connections for secure fitting and tightness.



New injectors have their position marked on their packing or injector table on injector table, page **Error! Bookmark not defined.** can be referred to.



((Varies depending on the product model.))
On some hob burners, the injector is covered with a metal piece. This metal cover must be removed for injector replacement.

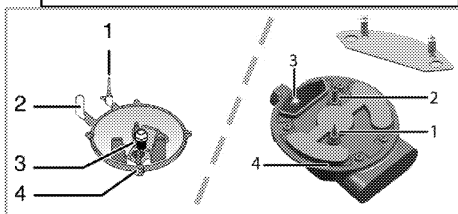

- 1 Flame failure device (model dependant)
- 2 Spark plug
- 3 Injector
- 4 Burner



Unless there is an abnormal condition, do not attempt to remove the gas burner taps. You must call an Authorised service agent or technician with licence if it is necessary to change the taps.

Reduced gas flow rate setting for hob taps

1. Ignite the burner that is to be adjusted and turn the knob to the reduced position.
2. Remove the knob from the gas tap.
3. Use an appropriately sized screwdriver to adjust the flow rate adjustment screw.

For LPG (Butane - Propane) turn the screw clockwise. For the natural gas, you should turn the screw **counter-clockwise** once.

» The normal length of a straight flame in the reduced position should be 6-7 mm.

4. If the flame is higher than the desired position, turn the screw clockwise. If it is smaller turn anticlockwise.

5. For the last control, bring the burner both to high-flame and reduced positions and check whether the flame is on or off.

Depending on the type of gas tap used in your appliance the adjustment screw position may vary.

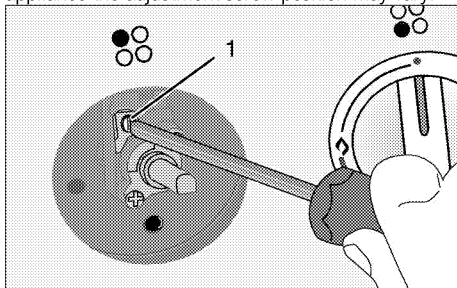

- 1 Flow rate adjustment screw

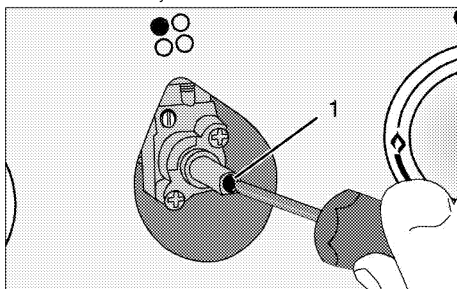

- 1 Flow rate adjustment screw

Exchange of injector for grill burner

1. Unscrew the screws fixing the rear cover sheet .

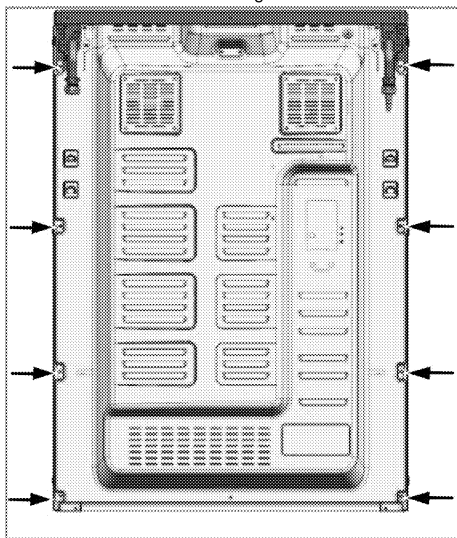

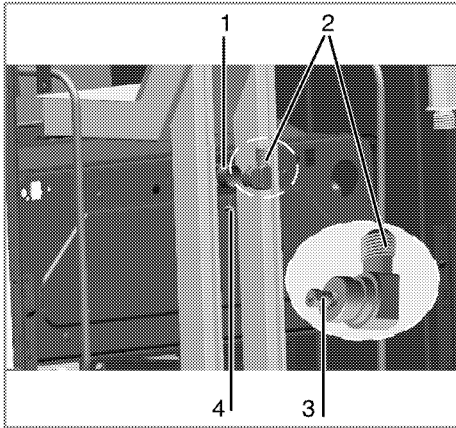

- 1 Grill burner
- 2 Injector holder
- 3 Injector
- 4 Fixing screw
2. After removing the rear cover sheet, you can reach the grill burner tube (1) and grill injector holder (2).
3. Unscrew the grill injector holder (2) fixing screw (4).
4. Unscrew the injector (3) and replace it with appropriate injector, see injector table, on *Injector table*, page **Error! Bookmark not defined.**
5. Conduct the leakage control after replacing the injector.
6. Assemble the injector holder (2) into the grill burner tube (1).
7. Fix the injector holder by the screw (4).
8. Assemble the rear cover sheet.

Exchange of injector for oven burner

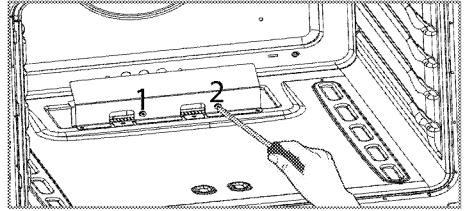

Unscrew 2 screws to remove burner protection sheet showing in the picture.

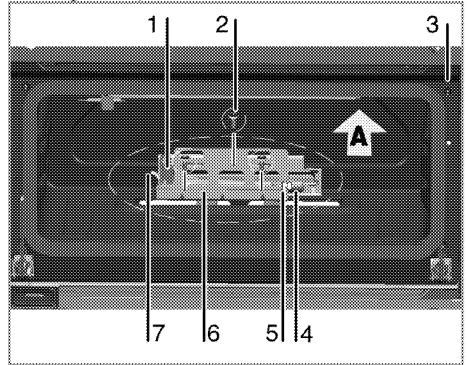

- 1 Oven burner
- 2 Screw (3 pieces)
- 3 Cut-off valve
- 4 Injector holder
- 5 Injector
- 6 Oven burner holder
- 7 Clips

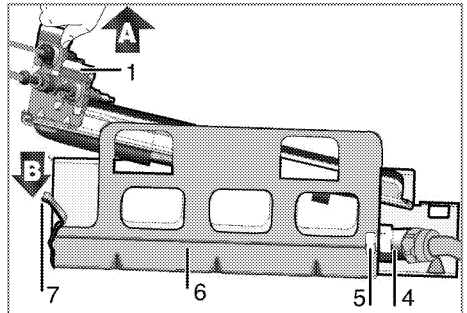

1. Unscrew 3 screws (2) to remove oven burner (1) and oven burner holder (7).
2. Gently pull up burner and holder in "A" direction- be careful with gas connection tube and thermocouple.
3. Push the clips (7) in "B" direction to disassemble oven burner (1) and its holder(6).

4. Unscrew the injector (5) and replace it with appropriate injector, see, *Injector table, page Error! Bookmark not defined.* injector table.
5. Conduct the leakage control after replacing the injector.
6. Assemble the oven burner (1) to its holder (6) by pushing the burner on the clips (7) in "B" direction.
7. Mount the oven burner (1) and holder (6) as a group to the cavity by screwing 3 screws (2).

Reduced flow adjustment for the gas oven

For the appropriate functioning of the oven re-checking the by-pass adjustment is extremely important. In order to provide maximum security to the user these operations have to be done with care.

1. Ignite the burner that is to be adjusted and turn the knob to the high flame position.
2. Close the oven door and wait for 10 to 15 minutes until the oven becomes ready for adjustment.
3. Take out the knob
4. After 15 minutes, adjust the oven to the lowest flame position.

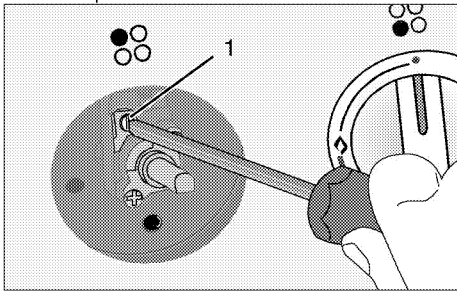

5. Set the flame length to 2 to 3 mm by means of the screw 1 on the oven tap. Turning in clockwise direction reduces the flame, turning counter-clockwise increases the flame.

	<p>If gas flow rate of oven cannot be set with removing knob, please remove the needed oven parts (control panel, burner plate etc.) and then set the gas flow rate of oven.</p>
	<p>If the temperature of the oven increases unintendedly, turn off the oven and call the authorised service agent or technician with licence to have oven thermostat repaired.</p>
	<p>If the gas type of the unit is changed, then the rating plate that shows the gas type of the unit must also be changed.</p>

Leakage check at the injectors

Before carrying out the conversion on the product, ensure all control knobs are turned to off position.

After the correct conversion of injectors, for each injectors should be gas leak checked.

1. Make sure that the gas supply to the product is on, still maintaining all control knobs turned to off position.
2. Each injector hole is blocked with a finger applying reasonable force to stop the gas leakage when corresponding control knob turned to on and it held at depressed position to allow gas reach the injector.
3. Apply prepared soapy water at the injector connection with a small brush, if there is leakage of gas at the injector connection the soapy water will begin to froth. In this case, tighten the injector with a reasonable force and repeat step 3 process once again.
4. If the froth still persist you must turn off the gas apply to the product immediately and call an Authorised service agent or technician with licence. Do not use the product until the authorized service has intervened in the product.

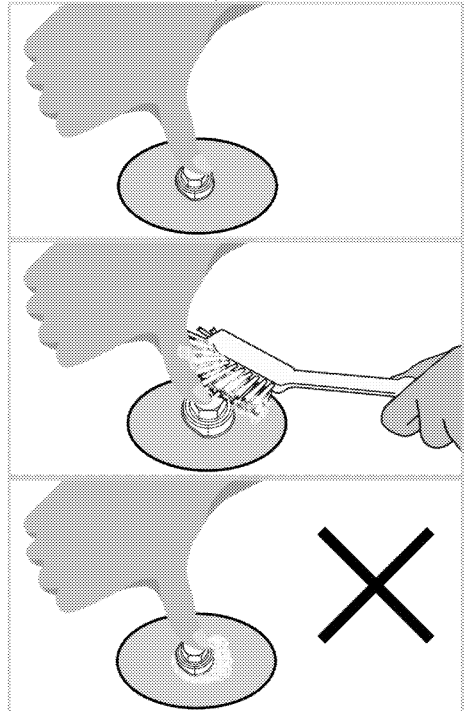

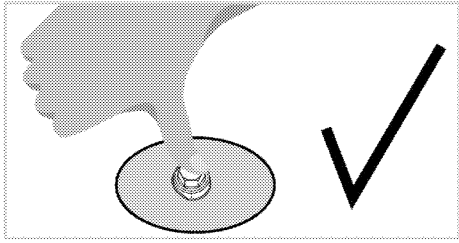

4 Preparation

Tips for saving energy

The following information will help you to use your appliance in an ecological way, and to save energy:

- Use dark coloured or enamel coated cookware in the oven since the heat transmission will be better.
- While cooking your dishes, perform a preheating operation if it is advised in the user manual or cooking instructions.
- Do not open the door of the oven frequently during cooking.
- Try to cook more than one dish in the oven at the same time whenever possible. You can cook by placing two cooking vessels onto the wire shelf.
- Cook more than one dish one after another. The oven will already be hot.
- Defrost frozen dishes before cooking them.
- Use pots/pans with cover for cooking. If there is no cover, energy consumption may increase 4 times.
- Select the burner which is suitable for the bottom size of the pot to be used. Always select the correct pot size for your dishes. Larger pots require more energy.
- Information on energy efficiency according to EU 66/2014 can be found on the product fiche given with the product.

Initial use

First cleaning of the appliance



The surface might get damaged by some detergents or cleaning materials.

Do not use aggressive detergents, cleaning powders/creams or any sharp objects during cleaning.

Do not use harsh abrasive cleaners or sharp metal scrapers to clean the oven door glass since they can scratch the surface, which may result in shattering of the glass.

1. Remove all packaging materials.

2. Wipe the surfaces of the appliance with a damp cloth or sponge and dry with a cloth.

Initial heating

Heat up the product for about 30 minutes and then switch it off. Thus, any production residues or layers will be burnt off and removed.



WARNING

Hot surfaces cause burns!

Product may be hot when it is in use. Never touch the hot burners, inner sections of the oven, heaters and etc. Keep children away. Always use heat resistant oven gloves when putting in or removing dishes into/from the hot oven.

Gas oven

1. Take all baking trays and the wire grill out of the oven.
2. Close the oven door.
3. Select the highest flame of the gas oven; see *How to use the gas oven, page 27*.
4. Operate the oven about 30 minutes.
5. Turn off your oven; See *How to use the gas oven, page 27*



Smoke and smell may emit for a couple of hours during the initial operation. This is quite normal. Ensure that the room is well ventilated to remove the smoke and smell. Avoid directly inhaling the smoke and the smell that emits.

5 How to use the hob

General information about cooking



Never fill the pan with oil more than one third of it. Do not leave the hob unattended when heating oil. Overheated oils bring risk of fire. **Never attempt to extinguish a possible fire with water!** When oil catches fire, cover it with a fire blanket or damp cloth. Turn off the hob if it is safe to do so and call the fire department.

- Before frying foods, always dry them well and gently place into the hot oil. Ensure complete thawing of frozen foods before frying.
- Do not cover the vessel you use when heating oil.
- Place the pans and saucepans in a manner so that their handles are not over the hob to prevent heating of the handles. Do not place unbalanced and easily tilting vessels on the hob.
- Do not place empty vessels and saucepans on cooking zones that are switched on. They might get damaged.
- Operating a cooking zone without a vessel or saucepan on it will cause damage to the product. Turn off the cooking zones after the cooking is complete.
- As the surface of the product can be hot, do not put plastic and aluminum vessels on it. Such vessels should not be used to keep foods either.
- Use flat bottomed saucepans or vessels only.
- Put appropriate amount of food in saucepans and pans. Thus, you will not have to make any unnecessary cleaning by preventing the dishes from overflowing.

Do not put covers of saucepans or pans on cooking zones.

Place the saucepans in a manner so that they are centered on the cooking zone. When you want to move the saucepan onto another cooking zone, lift and place it onto the cooking zone you want instead of sliding it.

Gas cooking

- Size of the vessel and the flame must match each other. Adjust the gas flames so that they will not extend the bottom of the vessel and center the vessel on saucepan carrier.

Using the hobs

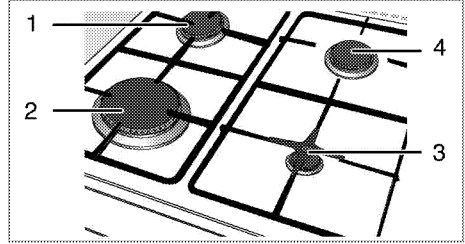

List of advised diameter of pots to be used on related burners.

- 1 Normal burner 18-20 cm
- 2 Rapid burner 22-24 cm
- 3 Auxiliary burner 12-18 cm
- 4 Normal burner 18-20 cm is list of advised diameter of pots to be used on related burners.



WARNING

Do not use cooking pans beyond the dimension limits given above. Using larger pans causes risk of carbon monoxide poisoning, overheating of adjacent surfaces and control knobs. Using smaller pans causes your risk of being burned by the flame.



WARNING

Parts or components of your product may be damaged due to high heat during cooking with similar accessories used for making embers and not recommended in the manual. Damage caused by such use is the responsibility of the user.

Large flame symbol indicates the highest cooking power and small flame symbol indicates the lowest cooking power. In turned off position (top), gas is not supplied to the burners.

Igniting the gas burners



Gas burners are ignited with ignition buttons.

1. Keep burner knob pressed.
2. Turn it counter clockwise to large flame symbol.
3. Press and release the ignition button. Repeat the procedure until the released gas is ignited.

4. Adjust it to the desired cooking power.

Turning off the gas burners

Turn the knob to off (upper) position.

Gas shut off safety system (in models with thermic component)

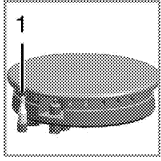

As a counter measure against blow out due to fluid overflows at burners, safety mechanism trips and shuts off the gas.

1. Gas shut off safety

- Push the knob inwards and turn it counter clockwise to ignite.
- After the gas ignites, keep the knob pressed for 3-5 seconds more to engage the safety system.
- If the gas does not ignite after you press and release the knob, repeat the same procedure by keeping the knob pressed for 15 seconds.



DANGER:

Release the button if the burner is not ignited within 15 seconds.

Wait at least 1 minute before trying again.

There is the risk of gas accumulation and explosion!

6 How to operate the oven

General information on baking, roasting and grilling



WARNING

Hot surfaces cause burns!
Product may be hot when it is in use. Never touch the hot burners, inner sections of the oven, heaters and etc. Keep children away. Always use heat resistant oven gloves when putting in or removing dishes into/from the hot oven.



DANGER:

Be careful when opening the oven door as steam may escape.
Exiting steam can scald your hands, face and/or eyes.

Tips for grilling

When meat, fish and poultry are grilled, they quickly get brown, have a nice crust and do not get dry. Flat pieces, meat skewers and sausages are particularly suited for grilling as are vegetables with high water content such as tomatoes and onions.

- Distribute the pieces to be grilled on the wire shelf or in the baking tray with wire shelf in such a way that the space covered does not exceed the size of the heater.
- Slide the wire shelf or baking tray with grill into the desired level in the oven. If you are grilling on the wire shelf, slide the baking tray to the lower rack to collect fats. Add some water in the tray for easy cleaning.



Foods that are not suitable for grilling carry the risk of fire. Only grill food which is suitable for intensive grilling heat.
Do not place the food too far in the back of the grill. This is the hottest area and fatty food may catch fire.

Tips for baking

Select the correct shelf position before turning the oven on – don't move oven shelves when hot.

- Always preheat the oven first for 10 minutes to ensure the food is at the correct temperature as soon as it goes into the oven.
- Use good quality baking tins such as non stick or aluminium. Line tins with greaseproof or baking paper to prevent sticking, if necessary.
- Do not fill cake tin more than half full.

- If baking one tray of food or cake, place centrally on the shelf level and centrally in the oven.
- If cooking on more than one level, swop food between the shelves at least halfway through cooking.
- Try not to open the oven door too much during cooking.
- To check if a cake is cooked, insert a skewer or cocktail stick into the centre. If it comes out clean, the cake is done, if it has food stuck to it, continue to cook the cake for a few minutes more and repeat the process.

Tips for roasting

Preheat oven first.

- If possible take meat or poultry out of refrigerator 30 minutes before cooking.
- Weigh meat first and calculate how long it will take to cook.
- Before cooking meat or poultry, lightly coat with butter or oil and season with salt, pepper, herbs, or other seasoning. Place in a roasting dish and use a rack to lift the meat out of its juices. Place dish in centre of oven.
- Turn meat over halfway through cooking.
- If the roasted meat is covered with foil, (it helps to keep the oven clean), always uncover for the last half an hour of cooking to allow browning.
- Remove meat from oven once cooked and stand covered in foil for 10-15 minutes to allow the meat to relax and juices to be reabsorbed which ensures the roast is tender and moist.

How to use the gas oven

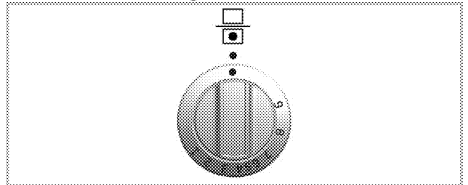

The gas oven is operated by the gas oven control knob. In off position (top) the gas supply is Off.

Switch on the gas oven

The gas oven is ignited with the ignition button.

1. Open oven door.
2. Keep gas oven control knob pressed and turn it **counterclockwise**.
3. Press ignition button and release it again.
4. Keep the gas oven control knob pressed for 3 to 5 seconds.

- » Repeat the process until the emanating gas is ignited.
5. Keep the gas oven control knob pressed for another 3 to 5 seconds. Be sure that gas has ignited and flame is present.
 6. Select the desired baking power/ gas mark.
 7. If there is no electricity; ignite the gas with the gas lighter from the ignition control hole.



DANGER:

There is the risk of gas compression and explosion!

Do not attempt to ignite the gas more than 15 seconds. If the burner is not ignited within 15 seconds, turn off the knob and wait for 1 minute. Ventilate the room before reattempting to ignite the burner. There is the risk of gas compression and explosion!



Switch off the gas oven

1. Turn gas oven control knob to off position (top).

Gas level temperature conversion chart

Gas level	1	2	3	4	5	6	7	8	9
Temperature in °C	130	135	150	170	180	200	210	240	270

Cooking times table

	1st rack of the oven is the bottom rack.
	Maximum load capacity of oven tray: 4 kg (8.8 lb).
	The timings in this chart are meant as a guide. Timings may vary due to temperature of food, thickness, type and your own preference of cooking.

Stand dishes on a baking sheet to prevent spillages onto oven base and help keep oven clean.

Baking and roasting

Food	Preheating *	Insertion level	Control knob position	Cooking time
Roast beef; Sirloin, topside, topump, rib	10 min.	2	6 - 7	20...40 mins then per 450 g/lb + 30 mins Medium 20 mins then per 450 g/lb + 20 mins, Well done 25 mins then per 450 g/lb + 25 mins
Roast Lamb; Leg, shoulder, rack, breast, whole neck fillet	10 min.	2	6 - 7	20...40 mins then per 450 g/lb + 20 mins
Roast pork; loin, shoulder, leg	10 min.	2	6 - 7	20...40 mins then per 450 g/lb + 25 mins
Roast chicken	10 min.	2	7 - 8	30...40 mins then per 450 g + 20 mins
Roast turkey	10 min.	2	7 - 8	30...40 mins, then per 450 g + 25 mins
Casseroles	–	2	4 - 5	2...3 hours
Whole fish	10 min.	2	4 - 5	25...35 mins [§]
Pasta bake	10 min.	3	5	30...40 mins [§]
Fruit pies (260mm)	10 min.	3	5 - 6	50...65 mins [§]
Pizza	10 min.	4	7	30...40 mins, depending on thickness [§]
Small cakes - One tray	10 min.	3	4 - 5	30...50 mins
Victoria sandwich	10 min.	3	4 - 5	30...50 mins
Biscuits	10 min.	3	5	15...25 mins
Scones	10 min.	3	5	15...25 mins
Rich fruit cake (20-22cm)	10 min.	3	3	3...4 hours

* at control knob position 7 / [§] depending on quantity / [§] depending on size

How to operate the gas grill

 **WARNING**
Hot surfaces may cause burns! Keep children away from the product.
Oven door remains slightly inclined when opened full and thus, possible splashes do not reach you.

 **WARNING**
This product is designed for OPEN DOOR GRILLING.

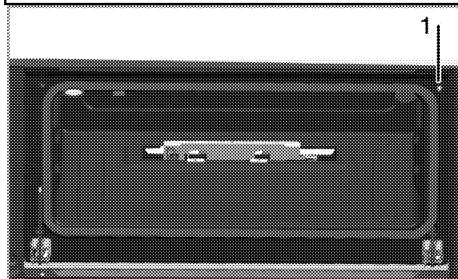

1. Cut-off valve

 The grill door has a cut-off valve (2). As a safety feature, this valve prevents the grill from working when the door is closed.

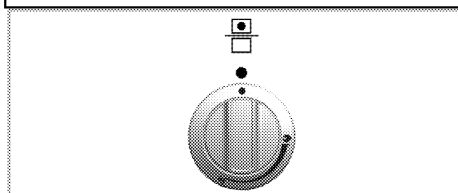

The grill is operated by the grill control knob. In off position (top) the gas supply is locked.

When the door fully open, it remains tilted slightly, so that any spillage will be directed away from you.

Switching on the grill

Gas grill is ignited with the ignition button.

1. Open the oven door.
2. Keep the knob pressed and turn it **counterclockwise** to the Grill symbol.
3. Press and release the ignition button.
» Repeat the procedure until the gas is ignited.
4. Keep the knob pressed for 3 to 5 seconds more.
5. Make sure that the grill is ignited.
6. If there is no electricity; ignite the gas with a gas lighter direct to grill burner.

 **DANGER**
There is the risk of gas compression and explosion!
Do not attempt to ignite the gas more than 15 seconds. If the burner is not ignited within 15 seconds, turn off the knob and wait for 1 minute. Ventilate the room before reattempting to ignite the burner. There is the risk of gas compression and explosion!

Switching off the grill

1. Turn the Grill control knob to Off (upper) position.



 Do not use the top rack for grilling.

 Foods that are not suitable for grilling carry the risk of fire. Only grill food which is suitable for intensive grilling heat.

Do not place the food too far in the back of the grill. This is the hottest area and fatty food may catch fire.

Cooking times table

- If food is cooking too quickly, it can be placed in the bottom of the grill pan.
- Do not place cookware with rough bases on the oven door.
- Ensure that there is at least 25mm space at top of oven when grilling larger foods or cookware.
- Do not place aluminium foil on the wire rack to grill on.
- Turn food over to ensure it is cooked on both sides
- Preheat oven first

	1st rack of the grill is the bottom rack.
	Do not use the top rack for grilling.
	The timings in this chart are meant as a guide. Timings may vary due to temperature of food, thickness, type and your own preference of cooking.

Grilling

Food	Preparation/setting	Grilling time #
Toast	Place on wire rack in grill pan.	1-3 mins
Bacon	Place on wire rack in grill pan.	3-6 mins
Gammon steaks	Place on wire rack in grill pan.	8-15 mins
Beef burgers	Place on wire rack in grill pan.	8-15 mins
Sausages	Place on wire rack in grill pan.	6-10 mins
Chops, chicken pieces	Place on upturned wire rack in grill pan.	15-30 mins
Fish fillets, fish fingers	Place on wire rack in grill pan.	10-20 mins
Grilling /browning tops of foods e.g. cottage pie	Place on base of top oven.	3-6 mins
# depending on size resp. thickness		

7 Maintenance and care

General information

Service life of the product will extend and the possibility of problems will decrease if the product is cleaned at regular intervals.



DANGER:

Disconnect the product from mains supply before starting maintenance and cleaning works.

There is the risk of electric shock!



DANGER:

Allow the product to cool down before you clean it.

Hot surfaces may cause burns!

- Clean the product thoroughly after each use. In this way it will be possible to remove cooking residues more easily, thus avoiding these from burning the next time the appliance is used.
- No special cleaning agents are required for cleaning the product. Use warm water with washing liquid, a soft cloth or sponge to clean the product and wipe it with a dry cloth.
- Always ensure any excess liquid is thoroughly wiped off after cleaning and any spillage is immediately wiped dry.
- Do not use cleaning agents that contain acid or chloride to clean the stainless or inox surfaces and the handle. Use a soft cloth with a liquid detergent (not abrasive) to wipe those parts clean, paying attention to sweep in one direction.



The surface might get damaged by some detergents or cleaning materials.

Do not use aggressive detergents, cleaning powders/creams or any sharp objects during cleaning.

Do not use harsh abrasive cleaners or sharp metal scrapers to clean the oven door glass since they can scratch the surface, which may result in shattering of the glass.



Do not use steam cleaners to clean the appliance as this may cause an electric shock.

Cleaning the hob

Gas hobs

1. Remove and clean the saucepan carriers and burner caps.
2. Clean the hob.
3. Install the burner caps and make sure that they are seated correctly.
4. When installing the upper grills, pay attention to place the saucepan carriers so that the burners are centered.

Cleaning the control panel

Clean the control panel and knobs with a damp cloth and wipe them dry.



Do not remove the control buttons/knobs to clean the control panel.

Control panel may get damaged!

Cleaning the oven

To clean the side wall

(This feature is optional. It may not exist on your product.)

1. Remove the front section of the side rack by pulling it in the opposite direction of the side wall.
2. Remove the side rack completely by pulling it towards you.

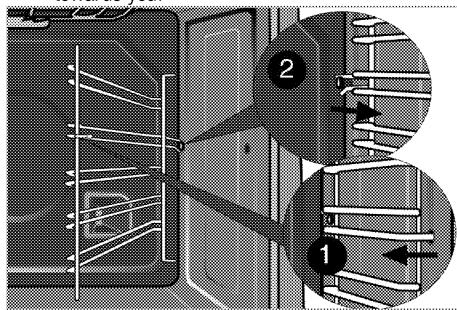

Catalytic walls

(This feature is optional. It may not exist on your product.)

The inner side walls (A) and/or the rear wall (B) of your product may be coated with catalytic enamel. Catalytic walls have a light matte colour and a porous surface. Catalytic walls of the oven should not be cleaned. Porous surfaces of the catalytic walls are automatically cleaned by absorbing and converting the spilled oil (steam and carbon dioxide).

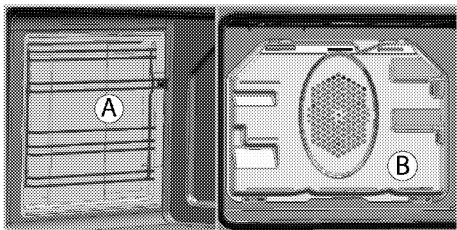

Clean oven door

To clean the oven door, use warm water with washing liquid, a soft cloth or sponge to clean the product and wipe it with a dry cloth.



Don't use any harsh abrasive cleaners or sharp metal scrapers for cleaning the oven door. They could scratch the surface and destroy the glass.

Removing the top oven door

1. Open the front door (1).
2. Open the clips at the hinge housing (2) on the right and left hand sides of the front door by pressing them down as illustrated in the figure.

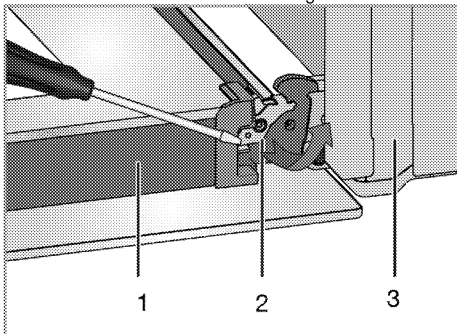

- 1 Door
- 2 Hinge lock(closed position)
- 3 Oven
- 4 Hinge lock(open position)

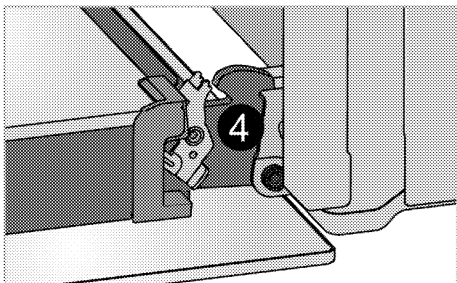

3. Move the front door to half-way.

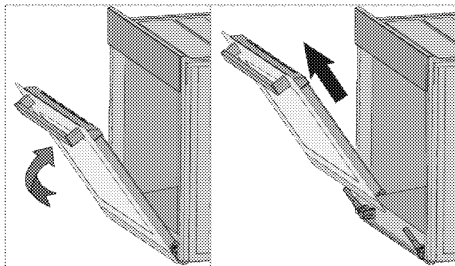

4. Remove the front door by pulling it upwards to release it from the right and left hinges.



Steps carried out during removing process should be performed in reverse order to install the door. Do not forget to close the clips at the hinge housing when reinstalling the door.

Removing the door inner glass

(This feature is optional. It may not exist on your product.)

The entire inner glass panel of the oven door can be removed for cleaning.

Open the oven door.

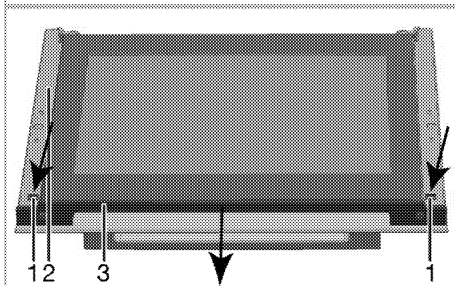
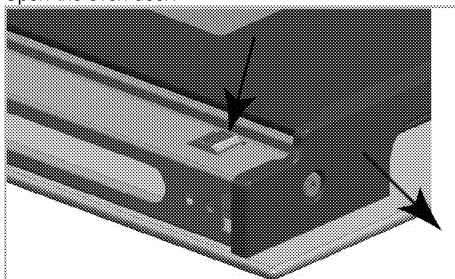

- 1 Tab
- 2 Frame
- 3 Profile

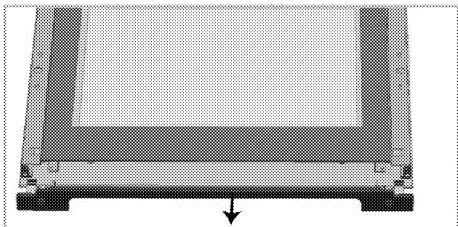

As illustrated in the figures above, press on the tabs (1) and pull the profile (3) towards yourself simultaneously to remove the profile attached to the upper side of the front door.

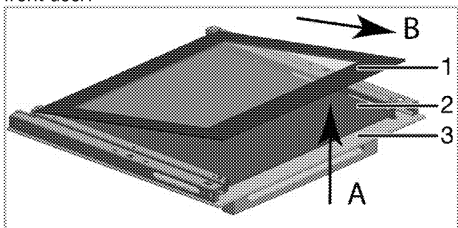

1 Innermost glass panel

2 Inner glass panel*

3 Outer glass panel

* (It may not exist on your product.)

As illustrated in the figure, raise the innermost glass panel (1) slightly in direction 'A' and pull it out in direction 'B'.

If your product is equipped with an inner glass panel; Pull the glass holder connecting elements in the middle as illustrated in the figure to free them from the glass panels.

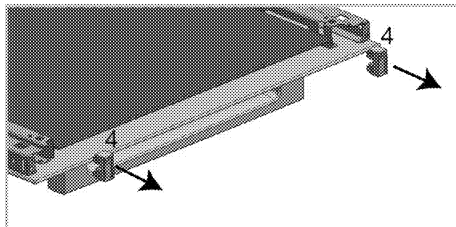

4 Glass holder connecting element*

* (It may not exist on your product.)

Repeat the same procedure to remove the inner glass panel (2). The first step to regroup the door is reinstalling inner glass panel (2).

As illustrated in the figure, place the glass panel so that it is inserted to the plastic slot.

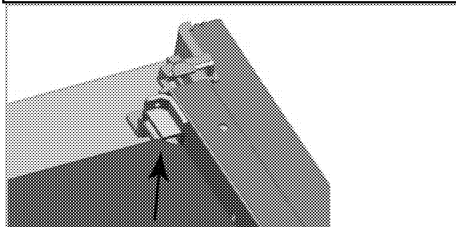
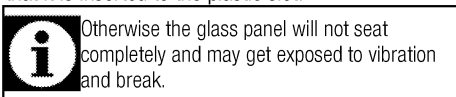

When installing the innermost glass panel (1), make sure that the printed side of the panel faces towards the inner glass panel.

It is important that the lower corners of the innermost glass panel are seated into the plastic slots.

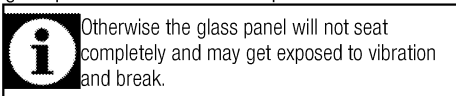

Please remember to place the glass holding connecting parts into their slots.

Finally, press on the tabs of the profile to make them seat into their slots again.

8 Troubleshooting

Oven emits steam when it is in use.

- It is normal that steam escapes during operation. >>> *This is not a fault.*

Product emits metal noises while heating and cooling.

- When the metal parts are heated, they may expand and cause noise. >>> *This is not a fault.*

There is no ignition spark.

- No current. >>> *Check fuses in the fuse box.*

There is no gas.

- Main gas valve is closed. >>> *Open gas valve.*
- Gas pipe is bent. >>> *Install gas pipe properly.*

Burners are not burning properly or at all.

- Burners are dirty. >>> *Clean burner components.*
- Burners are wet. >>> *Dry the burner components.*
- Burner cap is not mounted safely. >>> *Mount the burner cap properly.*
- Gas valve is closed. >>> *Open gas valve.*
- Gas cylinder is empty (when using LPG). >>> *Replace gas cylinder.*

Baking takes too long.

Pipe pressure is low. >>> *Adjust a higher gas mark.*



Consult the Authorised Service Agent or technician with licence or the dealer where you have purchased the product if you can not remedy the trouble although you have implemented the instructions in this section. Never attempt to repair a defective product yourself.

9 Guarantee Details

BEKO UK AND IRELAND STANDARD MANUFACTURER GUARANTEE TERMS AND CONDITIONS

Your new Beko product is guaranteed against faulty materials, defective components or manufacturing defects.

The standard guarantee starts from the date of original purchase of the product, and lasts for a period of twelve (12) months unless Beko plc (the "Manufacturer") agrees to extend the guarantee for the product in writing.

If you have purchased an American style Fridge freezer, the standard guarantee starts from the date of original purchase of the product, and lasts for a period of twenty four (24) months unless Beko plc (the "Manufacturer") agrees to extend the guarantee for the product in writing.

If you have any questions about the guarantee on your product (including how long it is valid), please contact your retailer or our contact centre on **0333 207 9710** (UK and Northern Ireland) or 01 862 3411 (Republic of Ireland)

This guarantee does not in any way diminish or affect your statutory rights in connection with the product. This guarantee is in addition to your statutory rights as a consumer. If you have any questions about these rights, please contact the retailer from which you purchased the product. In certain circumstances, it is possible that your statutory rights may offer additional or higher levels of protection than those offered under the terms of this guarantee.

What is covered by this guarantee?

- Repairs to the product required as a result of faulty materials, defective components or manufacturing defects.
- Functional replacement parts to repair a product.
- The costs of a Beko Approved Engineer to carry out the repair.

What is not covered?

- Transit and delivery damage.
- Cabinet or appearance parts, including but not limited to control knobs, flaps and handles.
- Accessories and/or consumable items including but not limited to ice trays, scrapers, cutlery baskets, filters and light bulbs.
- Repairs necessary as a direct or indirect result of:
 - Accidental damage, misuse or abuse of a product.
 - An attempted repair of a product by anyone other than a Beko Approved Engineer (the "Engineer").
 - Installation or use of a product where such installation or use fails to meet the requirements contained in this guarantee or the User Instructions Booklet.
- Repairs to a product operated at any time on commercial or non-residential household premises (unless we have previously agreed to the installation environment).

This guarantee is limited to the cost of repairing the product. To the extent permitted by law, the Manufacturer does not accept and will not be held liable for any financial loss incurred in connection with the failure of any product to operate in accordance with the expected standards. Such financial loss includes but is not limited to loss arising from:

- Time taken off work.

- Damaged food, clothing or other items.
- Meals taken at restaurants or from takeaways.
- General compensation for inconvenience.

Important Notes

1. Your product is designed and built for domestic household use only.
2. The guarantee will automatically be void if the product is installed or is used in commercial or non-residential domestic household premises, unless we have previously agreed to the installation environment.
3. The product must be correctly installed, located and operated in accordance with the instructions contained in the User Instructions Booklet provided with your product.
4. Professional installation by a qualified Electrical Domestic Appliance Installer is recommended for all Washing Machines, Dishwashers and Electric Cookers (as incorrect installation may result in you having to pay for the cost of repairing the product).
5. Gas Cookers must be professionally installed by a Gas Safe (or Gas Networks Ireland for Republic of Ireland) registered gas installer.
6. This guarantee is given in respect of products purchased and used within the United Kingdom and the Republic of Ireland.
7. This guarantee is effective from the initial date of purchase of a new product from an authorised retailer and will be void if the product is resold.
8. This guarantee does not apply to graded sales (where the product is purchased as a “second”).
9. Possession of a copy of these terms and conditions does not necessarily mean that a product has the benefit of this guarantee. If you have any questions, please call our Call Centre on the number set out above.
10. The Manufacturer reserves the right to terminate the guarantee if its staff or representatives are subjected to physical or verbal abuse in the course of carrying out their duties.
11. Optional extras, where available (i.e. extendable feet) are supplied on a chargeable basis only.

Does Beko offer replacements?

This is a repair-only guarantee. On occasion, the Manufacturer may at its sole discretion, replace your product with a new product instead of carrying out a repair. Where a replacement is offered, this would normally be an identical model but when this is not possible, a model of similar specification will be provided. The Manufacturer will cover the costs and arrange for the delivery of the new product and for the return of the old product. Any costs related to disconnecting the faulty product and installing the replacement product will not be borne by the Manufacturer unless previously agreed to in writing. The original guarantee will continue to apply to the replacement product; the new product will not come with a new guarantee.

When will the repair take place?

Our Engineers work Monday to Friday 9.00am to 5.00pm. Appointments outside these hours may be possible at the sole discretion of the Manufacturer but cannot be guaranteed. Whilst our Engineers will endeavour to minimize inconvenience and to meet requests for specific timed appointments, this cannot be guaranteed. We will not be liable for delays or if it is unable to carry out a repair because a convenient appointment cannot be arranged.

Will there be any charge for the repairs?

It is your responsibility to provide evidence to the Engineer that your product is covered by this guarantee with a proof of purchase. The Manufacturer reserves the right to charge for the reasonable cost of any service call if:

- You cannot provide evidence that your product is covered by this guarantee.
- Where a service call has been made and the engineer finds that there is no fault with your product.
- That your product has not been installed or operated in accordance with the User Instructions Booklet.
- That the fault was caused by something other than faulty materials, defective components or manufacturing defects.
- For missed appointments.

Payment of these costs are due immediately upon the Engineer providing you with an invoice. The Manufacturer reserves the right to terminate the guarantee if you fail to pay the costs for the service call in a timely manner.

If you are a resident of the United Kingdom, this guarantee will be governed by English law and subject to the English Courts, save where you live in another part of the United Kingdom, in which case the law and courts of that location will apply.

If you are resident in the Republic of Ireland, this guarantee will be governed by Irish law and the Irish courts will have jurisdiction.

This guarantee is provided by Beko plc. Beko House, 1 Greenhill Crescent, Watford, Hertfordshire. WD18 8QU.

Beko plc is registered in England and Wales with company registration number 02415578.

BEKO UK AND IRELAND BUILT-IN APPLIANCES GUARANTEE TERMS AND CONDITIONS

If you have purchased a built-in or integrated appliance, and registered it within 90 days of purchase by completing the online registration form, then the standard 12 month guarantee will be extended to 24 months, under the same terms and conditions as detailed in our Standard Guarantee Terms and Conditions.

BEKO UK AND IRELAND PROSMART INVERTER MOTOR GUARANTEE TERMS AND CONDITIONS

This 10 year guarantee relates to Beko products that feature the ProSmart Inverter Motor.

The ProSmart Motor guarantee terms and conditions are in addition to our Standard guarantee terms and conditions detailed in the previous section.

In order to activate the 10 year guarantee you MUST register the appliance within 90 days of the original purchase date. You can register by first visiting Beko.co.uk/register and by following the online instructions.

Beko Free standing appliances come with a 12 month parts and labour guarantee as standard,

Beko Built-in appliances come with a 12 month parts and labour guarantee as standard. This is extended to 24 months, free of charge, upon registration of the appliance. When you register your appliance for additional guarantee, you will automatically activate the ProSmart Motor 10 year guarantee. You do not need to register twice. (beko.co.uk/guarantee-terms).

To make a claim against your Beko ProSmart Inverter Motor Guarantee (the "Guarantee"), all customer and product details must be registered with Beko plc using the procedure outlined below.

1. This extra 9 years (for free standing appliances) or 8 years (for built-in or integrated appliances) guarantee is only effective after the expiration of the standard manufacturer's guarantee.
2. It is only valid for the ProSmart Inverter motors of selected washing machines, washer-dryers, tumble dryers and dishwashers. It does not cover any labour charge or any other components of the product. In addition, it is only valid for one replacement of the ProSmart motor during the extra 9-year (for free standing appliances) or 8 year (for built-in appliances) guarantee period.
3. To activate your guarantee, you MUST register your appliance within 90 days of the original purchase date, by visiting beko.co.uk/register.
4. Customers will receive a unique reference code as proof of guarantee validation by email or post, which must be quoted at the time of a claim being made.
5. Any repair/replacement of the ProSmart Inverter motor must only be carried out by an authorised Beko Service Agent (the "Service Agent").
6. Labour for the repair/replacement of the ProSmart Inverter motor is not included in this guarantee and is chargeable directly by the Service Agent.
7. Any additional components fitted to the product at any time will not be covered by this guarantee and will be chargeable directly by the Service Agent.
8. The guarantee is not transferable and cannot be exchanged for cash.
9. There are no alternative or additional offers to this Guarantee.
10. The guarantee is exclusive of the manufacturer's standard guarantee.

11. The Terms and Conditions shown above are in addition to the standard terms and conditions of your product guarantee. Please read and refer to such Terms and Conditions when making any claim.
12. We may use the information you provide for marketing purposes and to analyse your purchasing preferences. We may keep your information for a reasonable period for these purposes in accordance with the applicable Data Protection Laws and General Data Protection Regulations (GDPR). You can opt into this service during the registration process. Further details are available at <http://www.beko.co.uk/cookie-and-privacy>.
13. These Terms and Conditions are governed by the laws of England and Wales; manufacturer: Beko plc, Beko House, 1 Greenhill Crescent, Watford WD18 8QU. Company Registration Number: 02415578.

HOW TO OBTAIN SERVICE FOR YOUR APPLIANCE

Please keep your purchase receipt or other proof of purchase details in a safe place; you will need to have this documentation available should the product require attention under guarantee.

Please take a few moments to complete the details below, as you will need this information when you call us, or to use our online services. When you call us you may be required to input your serial number into your telephone keypad. For help please visit beko.co.uk/support/model-finder

- The product model number is printed on the Operating Instruction Booklet / User guide
- The product model and serial number is printed on the Rating Label affixed to the appliance.
- The Retailer (Purchased from) and Date of purchase will be printed on your purchase receipt or other proof of purchase paperwork

Recording of these details alone will not count as proof of purchase. A valid proof of purchase is required for requesting service under guarantee.

Model number	Serial number	Purchased from	Date of purchase

For service under guarantee or for product advice please call our Contact centre

Before requesting service please check the troubleshooting guide in the Operating Instructions booklet, as a charge may be levied where no fault is found, and even though your product may still be under guarantee.

After arranging service the area around the product must be easily accessible to the Engineer, without the need for cabinets or furniture to be removed or moved.

It is your responsibility to ensure our Engineers have a clean and safe environment to carry out any repairs.

Please have your Model number and Serial number available when you call us, as you may be required to input your serial number into your telephone keypad during your call.

UK Mainland & Northern Ireland:

0333 207 9710

Landline or mobile calls to 0333 numbers cost no more than calls to geographic numbers 01 or 02, and are charged at the basic rate. Calls from landlines and mobiles are included in free call packages but please check with your telephone service provider for exact call charges.

Republic of Ireland:

01 862 3411

Service once the manufacturers guarantee has expired

If you have purchased an extended guarantee please refer to the instructions contained within the extended guarantee agreement document, otherwise please call us using the appropriate number above, where service can be obtained at a charge.

Should you experience any difficulty in obtaining service please call us on **0333 207 9710** or **01 862 3411**

Contact us through our website

Send us a secure message through our online contact us form. Please visit our website, click Contact Us and choose a product support topic from the list of options. Complete the required details and click send message.

Product registrations

For UK registrations please visit beko.co.uk/register and for the Republic of Ireland visit beko.ie/register.

