

beko



Microwave Oven
User Manual

MGB 25332 BG
MGB 25333 BG



Please read this manual first!

Dear Customer,

Thank you for purchasing a Beko product. We hope that you get the best results from your product which has been manufactured with high quality and state-of-the-art technology. Therefore, please read this entire user manual and all other accompanying documents carefully before using the product and keep it as a reference for future use. If you handover the product to someone else, give the user manual as well. Follow all warnings and information in the user manual.

Meanings of the symbols

Following symbols are used in the various section of this user manual:

	Important information and useful hints about usage.
	Warnings for dangerous situations concerning the safety of life and property.
	Warning for hot surfaces.



This product has been manufactured in environmental friendly modern plants without giving any harm to the nature.

This appliance conforms to the WEEE regulation.



It does not contain PCB.

CONTENTS

1 Important safety and environmental instructions 4-9

1.1 General safety.....	4
1.1.1 Electrical safety.....	5
1.1.2 Product safety.....	7
1.2 Intended use.....	7
1.3 Children's safety.....	8
1.4 Compliance with the WEEE Directive and disposal of waste products.....	9
1.5 Package information.....	9

2 Your microwave oven 10-11

2.1 Overview.....	10
2.1.1. Controls and parts.....	10
2.1.2. Technical data.....	10
2.1.3 Installing the turntable.....	11

3 Installation and connection 12-17

3.1 Installation and connection.....	12
3.2 Built-in installation.....	13
3.2.1 Furniture dimensions for built-in installation.....	13
3.2.2 Preparing the cabinet.....	14
3.2.3 Fixing the oven.....	15
3.3 Radio interference.....	16
3.4 Microwave cooking principles.....	16
3.5 Grounding instructions.....	16
3.6 Utensil test.....	17

4 Operation 18-23

4.1 Control panel.....	18
4.2 Operating instructions.....	18
4.2.1 Setting the time.....	18
4.2.2 Cooking with microwave oven.....	18
4.2.3 Microwave keypad instructions.....	19
4.3 Cooking with grill or combination mode.....	19
4.3.1 (Grill/Combination) Keypad instructions.....	20
4.4 Quick start.....	20
4.5 Defrost by weight.....	20
4.6 Defrost by time.....	20

4.7 Kitchen timer (counter).....	20
4.8 Auto menu.....	21
4.8.1 Auto cooking menu.....	22
4.9 Multi-step cooking.....	23
4.10 Query function.....	23
4.11 Child lock.....	23
4.12 Opening the oven door.....	23

5 Cleaning and maintenance 24

5.1 Cleaning.....	24
5.2 Storage.....	24

6 Troubleshooting 25

7 Guarantee and Service 26

01M-8847913200-1415-05
01M-8847893200-1415-05

1

Important safety and environmental instructions

This section contains safety instructions that will help protect from risk of fire, electric shock, exposure to leak microwave energy, personal injury or property damage. Failure to follow these instructions shall void any warranty.

1.1 General safety

- Do not attempt to start the oven when its door is open; otherwise you may be exposed to harmful microwave energy. Safety locks should not be disabled or tampered with.
- Do not place any object between the front side and the door of the oven. Do not allow dirt or cleaning agent remnants built-up on the closure surfaces.
- Any service works involving removal of the cover that provides protection against exposure to microwave energy must be performed by authorized persons/service. Any other approach is dangerous.
- Your product is intended for cooking, heating and defrost food at home. It must not be used for commercial purposes.

Manufacturer shall not be held liable for damages that have arisen from misuse.

- Do not use this appliance outdoors, bathrooms, humid environments or in places where the it can get wet.
- No responsibility or warranty claim shall be assumed for damages arising from misuse or improper handling of the appliance.
- Never attempt to dismantle the appliance. No warranty claims are accepted for damage caused by improper handling.
- Only use the original parts or parts recommended by the manufacturer.
- Do not leave this appliance unattended while it is in use.
- Always use the appliance on a stable, flat, clean dry, and non-slip surface.
- The appliance should not be operated with an external clock timer or separate remote control system.
- Before using the appliance for the first time, clean all parts. Please see the details given in the "Cleaning and Maintenance" section.

1

Important safety and environmental instructions

- Operate the appliance for its intended purpose only as described in this manual. Do not use abrasive chemicals or steam on this appliance. This oven is particularly intended for heating and cooking the food. It is not intended for industrial or laboratory use.
- Do not use your appliance to dry clothes or kitchen towels.
- Appliance becomes very hot while it is in use. Pay attention not to touch the hot parts inside the oven.
- Your oven is not designed to dry any living being.
- Do not operate the oven empty.
- Cooking utensil may get hot due to the heat transferred from the heated food to the utensil. You may need oven gloves to hold the utensil.
- Utensils shall be checked to ensure that they are suitable for use in microwave ovens.
- Do not place the oven on stoves or other heat generating appliances. Otherwise, it may be damaged and the warranty becomes void.
- Microwave oven must not be placed in a cabinet that is not in compliance with the installation instructions.
- Steam may come out while opening the covers or the foil after cooking the food.
- Use gloves while taking any kind of heated food out.
- The appliance and its accessible surfaces may be very hot when the appliance is in use.
- Door and outer glass may be very hot when the appliance is in use.

1.1.1 Electrical safety

- Beko Microwave Ovens comply with the applicable safety standards; therefore, in case of any damage on the appliance or power cable, it should be repaired or replaced by the dealer, service center or a specialist and authorized service alike to avoid any danger. Faulty or unqualified repair work may be dangerous and cause risk to the user.
- Make sure that your mains power supply complies with the information supplied on the rating plate of the appliance.

1

Important safety and environmental instructions

The only way to disconnect the appliance from the power supply is to remove the power plug from the power outlet.

- Use the appliance with a grounded outlet only.
- Never use the appliance if the power cable or the appliance itself is damaged.
- Do not use this appliance with an extension cord.
- Never touch the appliance or its plug with damp or wet hands.
- Place the appliance in a way so that the plug is always accessible.
- Prevent damage to the power cable by not squeezing, bending, or rubbing it on sharp edges. Keep the power cable away from hot surfaces and naked flame.
- Make sure that there is no danger that the power cable could be accidentally pulled or that someone could trip over it when the appliance is in use.
- Unplug the appliance before each cleaning and when the appliance is not in use.
- Do not pull the power cable of the appliance to disconnect it from its power supply and never wrap its power cable around the appliance.
- Do not immerse the appliance, power cable, or power plug in water or any other liquids. Do not hold it under running water.
- When heating food in plastic or paper containers, check the oven frequently due to the possibility of ignition.
- Remove the wire strings and/or metal handles of paper or plastic bags before placing bags suitable for use in microwave oven to the oven.
- Turn off the appliance or unplug it and hold its door closed to prevent ignition if you observe smoke.
- Do not use inside of the oven to store something. Do not leave paper items, cooking material or food inside the oven when it is not being used.
- The contents of feeding bottles and baby food jars must be stirred or shaken and the temperature must be checked before consumption, in order to avoid burns.

1

Important safety and environmental instructions

- This appliance is a Group 2 Class B ISM equipment. Group 2 contains all ISM (Industrial, Scientific and Medical) equipment in which radio-frequency energy is intentionally generated and/or used in the form of electromagnetic radiation for the treatment of material, and spark erosion equipment.
- Class B equipment is suitable for use in domestic establishments and establishments directly connected to a low voltage power supply network.
- Door or outer surface of the appliance may become hot when it is in use.
- Pierce food with thick crust such as potatoes, zucchinis, apples and chestnuts.
- Appliance must be placed so that the rear side is facing the wall.
- If the door or door seals are damaged, the oven must not be operated until it has been repaired by a qualified person.
- Before moving the appliance, please secure the turntable to prevent damage to it.
- Eggs in their shell and whole hard-boiled eggs must not be heated in microwave ovens since they may explode, even after microwave heating has ended.

1.1.2 Product safety

- Liquids or other food must not be heated in closed container as there is a risk of exploding.
- Heating the beverages with microwave may cause them to boil by splashing around after they have been taken out of the oven; so be careful when you are holding the containers.
- Do not roast anything in the oven. Hot oil may damage the components and materials of the oven, and it may even cause skin burns.

- Never remove the parts at the rear and sides of the appliance, which protect the minimum distances between the cabinet walls and the appliance in order to allow for the required air circulation.

1.2 Intended use

- Microwave oven is intended for built-in use only.
- Do not use the appliance for anything other than its intended use.
- Do not use the appliance as a heat source.

1

Important safety and environmental instructions

- Microwave oven is intended to thaw, cook and stew food only.
- Do not over-cook foods; otherwise, you may cause a fire.
- Do not use steam assisted cleaners to clean the appliance.
- Only allow children to use the oven without supervision when adequate instructions have been given so that the child is able to use the microwave oven in a safe way and understands the hazards of improper use.

1.3 Children's safety

- Extreme caution is advised when being used near children and persons who are restricted in their physical, sensory or mental abilities.
- This appliance can be used by the children who are at the age of 8 or over and by the people who have limited physical, sensory or mental capacity or who do not have knowledge and experience, as long as they are supervised with regard to safe use of the product or they are instructed accordingly or understand the risks of using the product. Children should not play with the appliance. Cleaning and user maintenance procedures should not be performed by children unless they are controlled by their elders.
- Danger of choking! Keep all the packaging materials away from children.
- Due to excessive heat that arises in grill and combination modes, children should only be allowed to use these modes under supervision of an adult.
- Keep the product and its power cable so that they are inaccessible by children under 8 years old.
- The appliance and its accessible surfaces may be very hot when the appliance is in use. Keep children away.

1

Important safety and environmental instructions

1.4 Compliance with the WEEE Directive and disposal of waste products



This product does not include harmful and prohibited materials specified in the "Regulation for Supervision of the Waste Electric and Electronic Appliances" issued by the Ministry of

Environment and Urban Planning. Complies with the WEEE Directive. This product has been manufactured with high quality parts and materials which can be reused and are suitable for recycling.

Therefore, do not dispose the product with normal domestic waste at the end of its service life. Take it to a collection point for the recycling of electrical and electronic equipment. Ask the local authority in your area for these collection points. Help protect the environment and natural resources by recycling used products.

1.5 Package information



Package of the product is made of recyclable materials in accordance with our National Legislation. Do not dispose of the packaging materials together with the domestic or other wastes. Take them to the packaging material collection points designated by the local authorities.

Take them to the packaging material collection points designated by the local authorities.

2 Your microwave oven

2.1 Overview

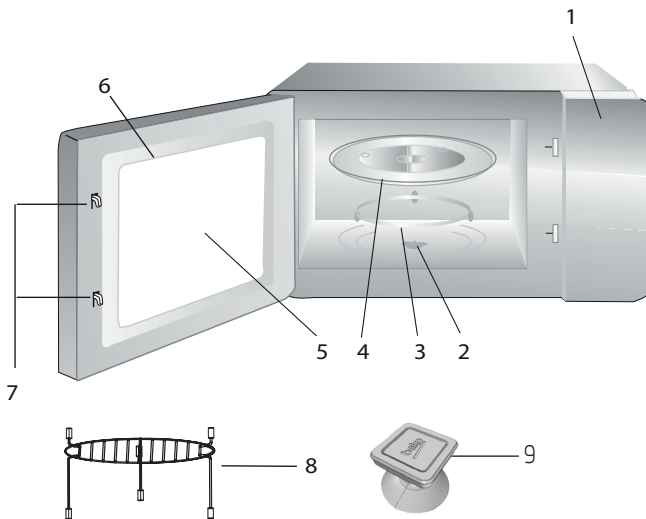

2.1.1. Controls and parts

1. Control panel
2. Turntable shaft
3. Turntable support
4. Glass tray
5. Oven window
6. Door group
7. Door safety interlock system
8. Grill rack (only to be used in grill function and placed on the glass tray)
9. Vacuum lifter for manual door opening (applies for model MGB 25333 BG.)

Power consumption	230 V~50 Hz, 1450 W (Microwave) 1000 W (Grill)
Output	900 W
Operating frequency	2450 MHz
Ampere value	6.4 A
External dimensions	388 mm (H) / 595 mm (W) / 400 mm (D)
Internal dimensions of the oven	206 mm (H) / 328 mm (G) / 368 mm (D)
Oven Capacity	25 Litres
Net weight	18.5 kg

2.1.2. Technical data

CE This appliance complies with the European Directives 2004/108/EC, 2006/95/EC, 2009/125/EC and 2011/65/EU.

Markings on the product or the values stated in other documents supplied with the product are values obtained under laboratory conditions as per relevant standards. These values may vary according to the usage of the appliance and ambient conditions. Power values are tested at 230V.

2 Your microwave oven

2.1.3 Installing the turntable

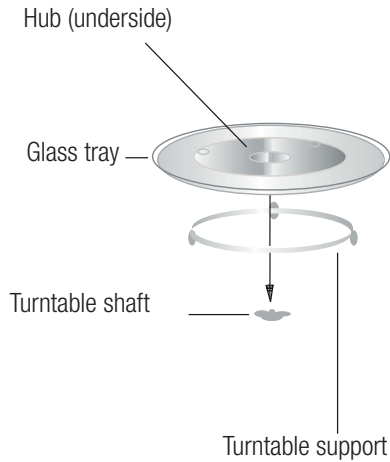

- Never place the glass tray upside down. The glass tray should never be restricted.
- Both glass tray and turntable support must always be used during cooking.
- All food and containers of food must always place on the glass tray for cooking.
- If glass tray or turntable support crack or break, contact your nearest authorized service center.

3 Installation and connection

3.1 Installation and connection

- Remove all packing material and accessories. Examine the oven for any damage such as dents or broken door. Do not install if oven is damaged.
- Remove any protective film found on the microwave oven cabinet surface.
- Do not remove the light brown Mica cover that is attached to the oven cavity to protect the magnetron.
- This appliance has been designed for domestic use only.
- This oven is intended for built-in use only. It is not intended for counter-top use or for use inside a cabinet.
- Please observe the special installation instructions.
- The appliance can be installed in a 60cm wide wall-mounted cabinet (at least 50 cm deep and 85 cm off the floor).
- The appliance is fitted with a plug and must only be connected to a properly installed grounded socket.
- The mains voltage must correspond to the voltage specified on the rating plate.
- If the plug is no longer accessible after installation, an all-pole isolating switch must be present on the installation side with a contact gap of at least 3 mm.
- Adapters, multi-way sockets and extension cords must not be used. Overloading can result with a risk of fire.



The accessible surface may be hot during operation.



Do not trap or bend the power cable.

3 Installation and connection

3.2 Built-in installation

3.2.1 Furniture dimensions for built-in installation

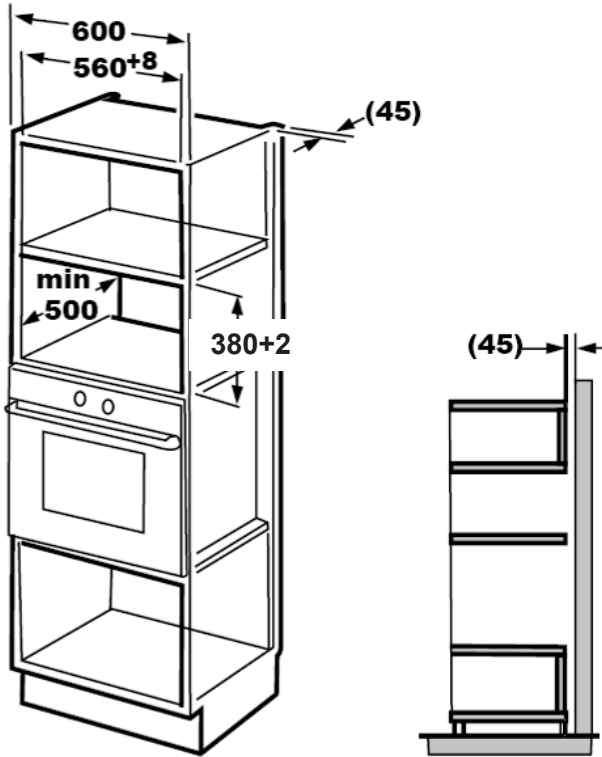

3 Installation and connection

3.2.2 Preparing the cabinet

1. Read the instruction on the bottom cabinet template and put the template on the bottom plane of cabinet.

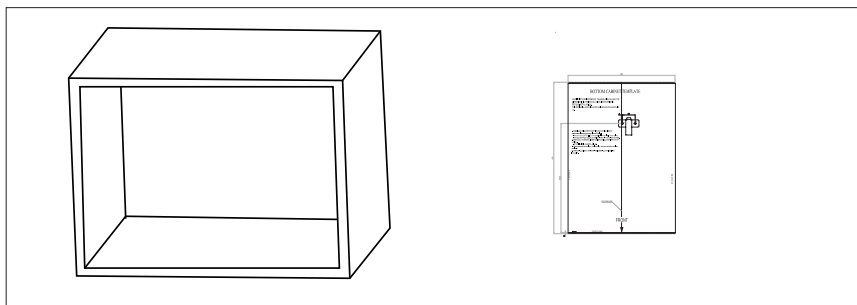

2. Make the marks on the bottom plane of cabinet according to marks "a" of the template.

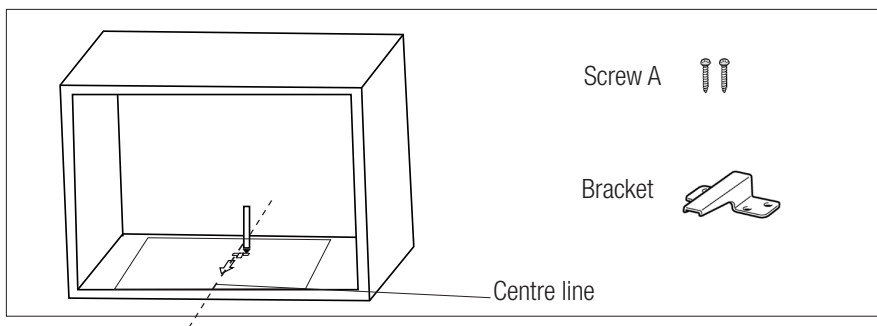

3. Remove the bottom cabinet template and fix the bracket with screw A.

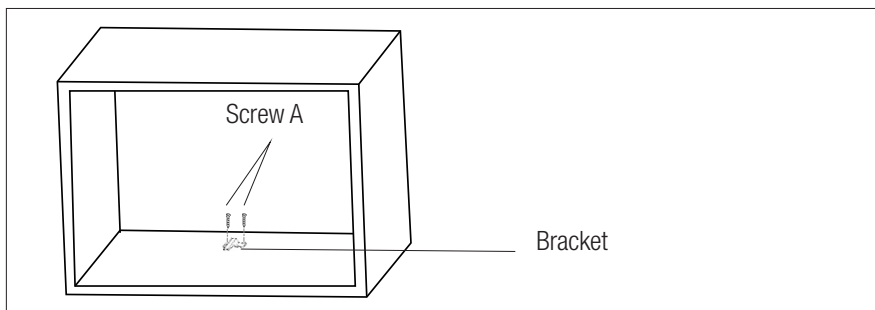

3 Installation and connection

3.2.3 Fixing the oven

1. Install the oven into the cabinet.
 - Make sure the back of the oven is locked by bracket.
 - Do not trap or bend the power cable.

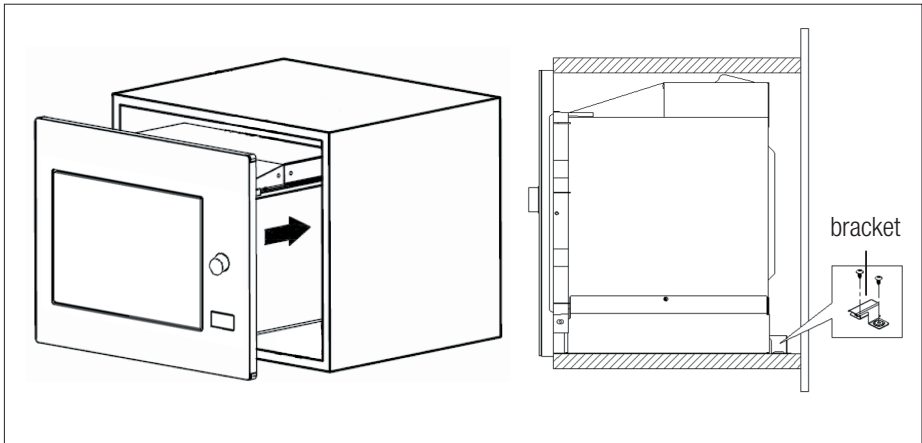

2. Open the door, fix the oven to the cabinet with Screw B through the installation hole. Then fix the trim-kit plastic cover to the installation hole.

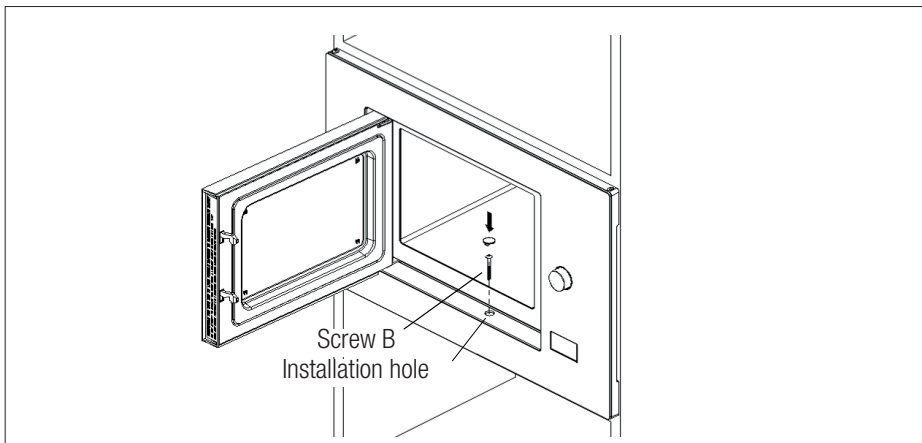

3 Installation and connection

3.3 Radio interference



Operation of the microwave oven may cause interference on radios, TVs and similar appliances.

- Place the oven as far away from radios and TVs as possible. Operation of microwave oven may cause interference to your radio or TV reception. 2. Plug your oven into a standard household outlet. Be sure the voltage and the frequency is the same as the voltage and the frequency on the rating plate.
- In case of interference, it may be reduced or eliminated by taking the precautions given below:
- Clean the door and sealing surface of the oven.
- Set the antenna direction of the radio or TV again.
- Reposition the oven based on the location of the receiver.
- Place microwave oven away from the receiver.
- Plug the microwave oven to another outlet, thus microwave oven and receiver shall be on different lines.

3.4 Microwave cooking principles

- Prepare the food carefully. Place the remaining parts to the outside of the dish.
- Pay attention to the cooking time. Cook in the shortest time specified and add some more time if required. Overcooked food may cause smoke or may be burnt.
- Cover the food while cooking. Covering the food prevents any splashing and helps to ensure that food is cooked evenly.

- Turn over food such as poultry and hamburgers while cooking them in a microwave oven in order to accelerate cooking of this kind of food. Larger food such as roast must be turned over at least once.
- Turn food such as meatballs upside down in the middle of the cooking and replace them with each other from the center of the dish to the outside.

3.5 Grounding instructions

This appliance must be grounded. This oven has a grounding cable with a grounded plug. Appliance must be plugged to a wall outlet installed and grounded correctly. Grounding system allows a leak wire for the electrical current in case of a short circuit and reduces the risk of electric shock. We recommend using an electrical circuit dedicated to the oven. Operating with high voltage is dangerous and may cause fire or other accidents that would cause damage to the oven.



WARNING: Misuse of grounding plug may cause electric shock.



If you have any questions on grounding and electrical instructions, please consult a qualified electric technician or service personnel.



Manufacturer and/or dealer would not accept any responsibility for injuries or damages on the oven that may occur when electrical connection procedures are not followed.

3 Installation and connection

3.6 Utensil test

Never operate the microwave oven empty. The only exception is the utensil test described in the following section. Some certain non-metal utensils may not be suitable for using in microwave. If you are not sure whether your utensil is suitable for microwave, you can perform the following test.

1. Place the empty utensil to be tested into the microwave oven together with a microwave-compatible glass filled with 250 ml water.
2. Operate the microwave oven at max power for 1 minute.
3. Check carefully the temperature of the utensil being tested. If it is warmed up, it is not suitable for use in microwave.
4. Never exceed the operating time limit of 1 minute. If you notice arcing during 1 minute of operation, stop the microwave. Utensils causing arcing are not suitable for use in microwave.

Following list is a general guide that would help you in selecting the right utensil.

Cooking utensil	Microwave	Grill	Combination
Heat-resistant glass	Yes	Yes	Yes
Non-heat-resistant glass	No	No	No
Heat-resistant ceramics	Yes	Yes	Yes
Plastic dish suitable for microwave oven	Yes	No	No
Paper kitchenware	Yes	No	No
Metal tray	No	Yes	No
Metal rack	No	Yes	No
Aluminum foil and foil covers	No	Yes	No
Foam materials	No	No	No

4 Operation

4.1 Control panel

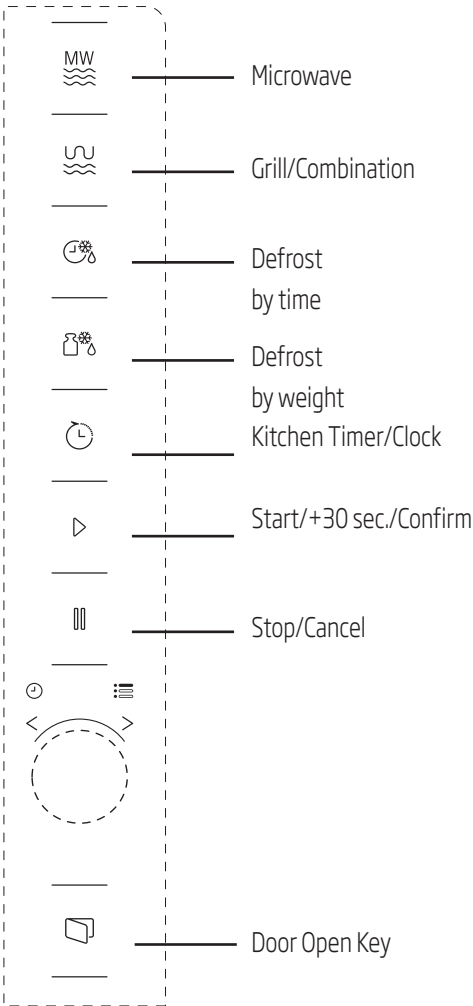

4.2 Operating instructions

4.2.1 Setting the time

When the microwave oven is energized, "0:00" will be displayed in LED screen and buzzer will ring once.

1. Press (Kitchen Timer/Clock) twice and the figures for hours will start flashing.
2. Turn to adjust the hour; the input value should be between 0 and 23.
3. Press (Kitchen Timer/Clock) and the figures for minutes will start flashing.
4. Turn to adjust the minutes; the input value should be between 0 and 59.
5. Press (Kitchen Timer/Clock) to finish time setting. ":" symbol will flash, and the time will light.





If you press (Stop/Cancel) during time setting, oven will automatically return back to previous mode.

4.2.2 Cooking with microwave oven







1. Press (Microwave) and "P100" will be displayed in LED screen.
2. Press (Microwave) again or turn to select the desired power. Each time you press the key, "P100", "P80", "P50", "P30" or "P10" will be displayed respectively.

4 Operation

- Press  (Start/+30 Sec./Confirm) to confirm and turn  to set the cooking time to a value between 0:05 and 95:00.
- Press  (Start/+30 Sec./Confirm) again to start cooking.



Example: If you want to use 80% microwave power to cook for 20 minutes, you can operate the oven with the following steps.

- Press  (Microwave) once and "P100" will be displayed in the screen.
- Press  (Microwave) once again or turn  to set 80% microwave power.
- Press  (Start/+30Sec./Confirm) to confirm and "P 80" will be displayed in the screen.
- Turn  to adjust the cooking time until the oven displays "20:00".
- Press  (Start/+30 Sec./Confirm) to start cooking.







The steps for adjusting the time in coding button are as below:

Setting the duration	Increment amount
0-1 minute	5 seconds
1-5 minutes	10 seconds
5-10 minutes	30 seconds
10-30 minutes	1 minute
30-95 minutes	5 minutes

4.2.3 Microwave keypad instructions





Order	Screen	Microwave Power
1	P100	100%
2	P80	80%
3	P50	50%
4	P30	30%
5	P10	10%

4.3 Cooking with grill or combination mode



- Press  (Grill/Combination) and "G" will be displayed in LED screen. Press  (Grill/Combination) repeatedly or turn  to select the desired power. Each time you press the key, "G", "C-1" or "C-2" will be displayed respectively.
- Press  (Start/+30 Sec./Confirm) to confirm and turn  to set the cooking time to a value between 0:05 and 95:00.
- Press  (Start/+30 Sec./Confirm) again to start cooking.



Example: If you want to use 55% microwave power and 45% grill power (C-1) to cook for 10 minutes, you can operate the oven with the following steps.

- Press  (Grill/Combination) once and "G" will be displayed in the screen.
- Press  (Grill/Combination) once again or turn  to select the Combination 1 mode.
- Press  (Start/+30Sec./Confirm) to confirm and "C-1" will be displayed in the screen.

4 Operation

- Turn  to adjust the cooking time until the oven displays "10:00".
- Press  (Start/+30 Sec./Confirm) to start cooking.



4.3.1 (Grill/Combination) Keypad instructions



Order	Screen	Micro-wave Power	Grill Power
1	G	0%	100%
2	C-1	55%	45%
3	C-2	36%	64%



When half the grill time passes, the oven sounds twice, and this is normal. In order to have a better grilling effect, you should turn the food over, close the door, and then press (Start/+30Sec./Confirm) to continue cooking. If no operation is performed, the oven will continue cooking.

4.4 Quick start



- In standby mode, press  (Start/+30Sec./Confirm) to start cooking with 100% microwave power. Each time you press the key, cooking time will increase until 95 minutes with steps of 30 seconds.
- In microwave oven cooking, grill and combination cooking or defrost by time modes, the cooking time will increase by 30 seconds each time you press  (Start/+30 Sec./Confirm).

- In standby mode, turn  counterclockwise to set the cooking time in order to start cooking with 100% microwave power and press  (Start/+30Sec./Confirm) to start cooking.





In auto menu and defrost by weight modes, pressing  (Start/+30Sec./Confirm) will not increase the cooking time.

4.5 Defrost by weight

- Press  (Defrost by weight) for once.
- Turn  to select the weight of food from 100 to 2000 g.
- Press  (Start/+30 Sec./Confirm) to start defrost.





4.6 Defrost by time

- Press  (Defrost by time) for once.
- Turn  to select the defrost time. The maximum time is 95 minutes.
- Press  (Start/+30 Sec./Confirm) to start defrost. Defrost power is P30 and cannot be changed.

4.7 Kitchen timer (counter)

Your oven is equipped with an automatic counter which is not linked with the oven functions and can be used separately at the kitchen (it can be set to max. 95 minutes.)

4 Operation





1. Press  (Kitchen Timer/Clock) for once and 00:00 will be displayed in LED screen.
 2. Turn  to enter the correct time.
 3. Press  (Start/+30Sec./Confirm) to confirm the setting.
 4. When the countdown from the entered time reaches to 00:00, the buzzer will ring for 5 times. If the time is set (24-hour system), current time will be displayed in LED screen.
- Press  (Stop/Cancel) to abort the timer at any-time.







Kitchen timer functions different than 24-hours system. Kitchen timer is just a timer.



Example: If you want to use "Auto Menu" to cook 350 g fish:

1. Turn  clockwise until "A-6" is displayed in the screen.
2. Press  (Start/+30Sec./Confirm) to confirm.
3. Turn  to select the weight of fish until "350" is displayed in the screen.
4. Press  (Start/+30 Sec./Confirm) to start cooking.

4.8 Auto menu

1. Turn  clockwise to select the desired menu. Menus between "A-1" and "A-8", namely pizza, meat, vegetable, pasta, potato, fish, beverage and popcorn, will be displayed.
2. Press  (Start/+30Sec./Confirm) to confirm.
3. Turn  to choose the default weight in accordance with the menu chart.
4. Press  (Start/+30 Sec./Confirm) to start cooking.

4 Operation

4.8.1 Auto cooking menu

Menu	Weight	Screen
A-1 Pizza	200 g	200
	400 g	400
A-2 Meat	250 g	250
	350 g	350
	450 g	450
A-3 Vegetable	200 g	200
	300 g	300
	400 g	400
A-4 Pasta	50 g (with 450 ml cold water)	50
	100 g (with 800 ml cold water)	100
A-5 Potato	200 g	200
	400 g	400
	600 g	600
A-6 Fish	250 g	250
	350 g	350
	450 g	450
A-7 Beverage	1 glass (120 ml)	1
	2 glasses (240 ml)	2
	3 glasses (360 ml)	3
A-8 Popcorn	50 g	50
	100 g	100

4 Operation

4.9 Multi-step cooking

At most 2 steps can be set for cooking. In multi-step cooking, if one step is defrosting, then defrosting must be placed in the first step.



If you want to thaw food for 5 minutes and then cook with 80% microwave power for 7 minutes, perform the following steps:

1. Press (Defrost by time) for once.
2. Turn to select the defrost time until "5:00" is displayed in the screen.
3. Press (Microwave) once and "P100" will be displayed in the screen.
4. Press (Microwave) once again or turn to set 80% microwave power.
5. Press (Start/+30Sec./Confirm) to confirm and "P 80" will be displayed in the screen.
6. Turn to adjust the cooking time until the oven displays "7:00".
7. Press (Start/+30Sec./Confirm) to start cooking. Buzzer will sound once for the first step and defrost time countdown will start. Buzzer will sound once again when entering the second cooking step. Buzzer will sound for 5 times at the end of cooking.

4.10 Query function

1. In microwave, grill and combination modes, press (Microwave) or (Grill/Combination) and the current power level will be displayed for 3 seconds. After 3 seconds, the oven will return to the previous mode.
2. While cooking, press (Kitchen Timer/Clock) and the current time will be displayed for 3 seconds.

4.11 Child lock

1. **Locking:** In standby mode, press (Stop/Cancel) for 3 seconds and a buzzer will sound indicating that the child lock is activated. If the time is already set, current time will also be displayed; otherwise will be displayed in the LED screen.
2. **Unlocking:** To disable the child lock, press (Stop/Cancel) for 3 seconds and a long "beep" will sound indicating that the child lock is disabled.

4.12 Opening the oven door

Press (Open door) and the oven door will be opened.



If the door cannot be opened with "open door" key in model MGB 25333 BG (e.g., due to power failure), you can open the door with vacuum lifter for opening the door manually.

5 Cleaning and maintenance

5.1 Cleaning



WARNING: Never use gasoline, solvent, abrasive cleaning agents, metal objects or hard brushes to clean the appliance.



WARNING: Never immerse the appliance or its power cable in water or in any other liquid.

1. Turn the appliance off and disconnect it from wall socket.
2. Wait for the appliance to completely cool down.
3. Keep the inside of the oven clean. Wipe with a damp cloth when splashed food or spilled liquids stick on the walls of the oven. A mild detergent may be used if the oven gets very dirty. Avoid using sprays and other harsh cleaning agents as they may cause stains, marks, and opaqueness on the door surface.
4. Outer surfaces of the oven must be cleaned with a damp cloth. Do not allow water ingress from ventilation openings to prevent damage to the operating parts in the oven.
5. Wipe both sides of the door and the glass, door gaskets and parts near the gaskets frequently with a damp cloth in order to remove the overflowing and splashing stains. Do not use abrasive cleaning agents.
6. Do not allow control panel to get wet. Clean with a soft damp cloth. Leave the door of the oven open to prevent inadvertent operation while cleaning the control panel.
7. If steam accumulates inside or around the oven door, wipe with a soft cloth. This may occur when the microwave oven is operated under high humidity conditions. It is normal.
8. In some cases, you may need to remove the glass tray for cleaning. Wash the tray in warm soapy water or in a dishwasher.
9. The roller ring and oven floor should be cleaned regularly to avoid excessive noise. It would be sufficient to wipe the lower surface of the oven with a mild detergent. Roller ring may be washed in warm soapy water or in a dishwasher. When you remove the roller ring from oven internal floor for cleaning, ensure that you install it in the correct position while replacing it.
10. In order to remove bad odors in your oven, put a glass of water and juice and peel of a lemon to a deep bowl suitable for use in microwave and operate the oven for 5 minutes in microwave mode. Wipe thoroughly and dry with a soft cloth.
11. Please contact the authorized service when the oven lamp needs to be replaced.
12. The oven should be cleaned regularly and any food deposits should be removed. If the oven is not kept clean, this may cause surface defects that would affect the lifecycle of the appliance negatively and that would possibly cause risks.
13. Please do not dispose this appliance with household waste; old ovens shall be disposed to special waste centers provided by the municipalities.
14. When the microwave oven is used in grill function, a small amount of smoke and odor may occur which will disappear after a certain time of usage.

5.2 Storage

- If you do not intend to use the appliance for a long time, please store it carefully.
- Please make sure that the appliance is unplugged, cooled down and totally dry.
- Store the appliance in a cool and dry place.
- Keep the appliance out of the reach of children.

6 Troubleshooting

Normal	
Microwave oven interferes with TV reception	Radio and TV reception may be interfered when microwave oven is operating. It is similar to the interference caused by small electrical appliances, like mixer, vacuum cleaner, and electric fan. It is normal.
Oven light is dimmed	In low power microwave cooking, oven light may be dimmed. It is normal.
Steam accumulating on door, hot air coming out of vents	During cooking, steam may arise from the food. Most of this steam will get out from vents. But some may accumulate on a cool place like oven door. It is normal.
Oven started accidentally with no food in it.	It is not allowed to run the appliance without any food inside. It is very dangerous.

Problem	Possible Reason	Solution
Oven cannot be started.	(1) Power cable is not plugged in properly.	Unplug. Then plug again after 10 seconds.
	(2) Fuse is blown or circuit breaker is activated.	Replace fuse or reset circuit breaker (repaired by professional personnel of our company).
	(3) Trouble with outlet.	Test the outlet with other electrical appliances.
Oven does not heat.	(4) Door is not closed properly.	Close the door properly.
Glass turntable makes noise when microwave oven operates	(5) Turntable and bottom of the oven is dirty.	Refer to "Cleaning and Maintenance" section to clean dirty parts.
Oven displays E-3 error and does not function (for model MGB 25333 BG)	(6) Oven door does not open (due to an obstruction in front of the door, low voltage and etc.)	Unplug. Then plug again after 10 seconds.

7 Guarantee and Service

Your Beko product is guaranteed against the cost of breakdown repairs: Freestanding appliances: 1 year
Built in appliances: 2 years
from the date of the original purchase.

What is covered?

- All repairs necessary as a result of faulty materials, defective components or manufacturing defect.
- The cost of functional replacement parts.
- The labor costs of a Beko approved repairer to carry out the repair.

What is not covered?

- Transit or delivery damage
- Accidental damage
- Misuse, or abuse
- Cabinet or appearance parts, including knobs and flaps
- Accessory items, including ice trays, scrapers, cutlery baskets
- Repairs required as a result of unauthorized repairs or inexperienced installation that fails to meet the requirements contained in the user instruction book.
- Repairs to products used on commercial or non-residential household premises

Important notes

- The product is guaranteed for domestic household use only.
- The guarantee will be void if the product is installed or used in commercial or non-residential domestic household premises.
- The product must be correctly installed, located and operated in accordance with the instructions contained in the User Instructions Booklet provided.
- Professional installation by a qualified plumber/electrical appliance installer is recommended for all Washing & Dishwashing Machines and Electric Cookers.
- Gas Cookers must only be installed by a Gas Safe (or BORD GAIS) registered Gas Installer.
- The guarantee is given only within the boundaries of the United Kingdom.
- The guarantee is not transferable if the product is resold.
- Beko plc disclaims any liability for incidental or consequential damages.
- The guarantee does not in any way diminish your statutory or legal rights.

HOW TO OBTAIN SERVICE UNDER THE MANUFACTURERS GUARANTEE

Please keep your purchase receipt or other proof of purchase in a safe place; you will need to have it should the product require attention in the guarantee period

You should also complete the details below; it will help us assist you quicker when requesting service. (The model number is printed on the Instruction Booklet)

Model Number: _____ Purchased From: _____ Date of purchase: _____

For service under guarantee simply telephone the appropriate number below

LOCATION	TELEPHONE
UK Mainland & Northern Ireland	
Fridges & Freezers	0845 600 4903/0345 600 4903
Electric Cookers	0845 600 4902/0345 600 4902
Gas & Dual Fuel Cookers	0845 600 4905/0345 600 4905
Washing Machines & Dishwashers	0845 600 4906/0345 600 4906
Republic of Ireland	
All Refrigeration, Cooking, Washing & Dishwashing Machines	01 862 3411

Before requesting service please check the troubleshooting guide in the Operating Instructions as a charge may be levied where no fault is found even though your product may still be under guarantee.
Service once the manufactures guarantee has expired.

If you have purchased an extended guarantee agreement document.
Otherwise please call the above numbers where service can be obtained at a charge.

Should you experience any difficulty in obtaining service please call the
Beko Customer Help-Line on 0845 600 4911/0345 600 4911
Beko Plc, Beko House, 1 Greenhill Crescent, Watford Herts, WD18 8QU, Tel: 0845 600 4911