

Blomberg

Built-in Hob User Manual

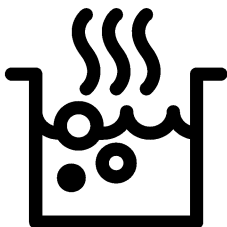

MIX5402F

EN

185.9285.96/R.AA/29.05.2020

7756384317

Please read these instructions first before using your appliance

Thank you for choosing a Blomberg appliance.

Please take some time to read this user manual before using your appliance, to ensure you know how to safely operate the controls and functions.

Carefully follow all unpacking and installation instructions to ensure the appliance is correctly connected and fitted prior to use.

Please write your product model and serial number on the last page of this user manual, and store in a safe location close to the appliance for easy future reference.

This user manual may also be applicable for several other models. Differences between models will be listed.

If you have any questions or concerns, please call our contact centre or find help and information online at www.blomberguk.com

Explanation of symbols used throughout this User Manual

Throughout this user manual the following symbols are used:



Important information or useful hints about usage.



Warning of hazardous situations with regard to life and property.



Warning of electric shock.



Warning of risk of fire.



Warning of hot surfaces.

TABLE OF CONTENTS

1 Important instructions and warnings for safety and environment **4**

General safety	4
Electrical safety.....	5
Product safety	5
Intended use	7
Safety for children.....	7
Disposing of the old product	8
Package information	8

2 General information **9**

Overview	9
Technical specifications	9

3 Installation **10**

Before installation	10
Installation and connection.....	11
Future Transportation.....	14

4 Preparation **15**

Tips for saving energy	15
Initial use	15
First cleaning of the appliance.....	15

5 How to use the hob **16**

General information about cooking ...	16
Using the hobs	19
Control panel.....	20

6 Maintenance and care **28**

General information.....	28
Cleaning the hob.....	28

7 Troubleshooting **30**

8 Guarantee Details **31**

1 Important instructions and warnings for safety and environment

This section contains safety instructions that will help protect from risk of personal injury or property damage. Failure to follow these instructions shall void any warranty.

General safety

- This appliance can be used by children aged from 8 years and above and persons with reduced physical, sensory or mental capabilities or lack of experience and knowledge if they have been given supervision or instruction concerning use of the appliance in a safe way and understand the hazards involved.

Children shall not play with the appliance. Cleaning and user maintenance shall not be made by children without supervision.

- The appliance is not to be used by persons (including children) with reduced physical, sensory or mental capabilities, or lack of experience and knowledge,

unless they have been given supervision or instruction.

Children should be supervised and ensure they do not play with the appliance

- If the product is handed over to someone else for personal use or second-hand use purposes, the user manual, product labels and other relevant documents and parts should be also given.
- Installation and repair procedures must always be performed by Authorised Service Agents. The manufacturer shall not be held responsible for damages arising from procedures carried out by unauthorised persons which may also void the warranty. Before installation, read the instructions carefully.
- Do not operate the product if it is defective or has any visible damage.
- Ensure that the product function knobs are switched off after every use.

Electrical safety

- If the product has a failure, it should not be operated unless it is repaired by an Authorised Service Agent. There is the risk of electric shock!
- Only connect the product to a grounded outlet/line with the voltage and protection as specified in the “Technical specifications”. Have the grounding installation made by a qualified electrician while using the product with or without a transformer. Our company shall not be liable for any problems arising due to the product not being earthed in accordance with the local regulations.
- Never wash the product by spreading or pouring water onto it! There is the risk of electric shock!
- The product must be disconnected during installation, maintenance, cleaning and repairing procedures.
- If the power connection cable for the product is damaged, it must be replaced by the manufacturer, its service agent or similarly qualified

persons in order to avoid a hazard.

- The appliance must be installed so that it can be completely disconnected from the mains supply. The separation must be provided by a switch built into the fixed electrical installation, according to construction regulations.
- Any work on electrical equipment and systems should only be carried out by authorised and qualified persons.
- In case of any damage, switch off the product and disconnect it from the mains. To do this, turn off the fuse at home.
- Make sure that fuse rating is compatible with the product.

Product safety

- **WARNING:** The appliance and its accessible parts become hot during use. Care should be taken to avoid touching heating elements. Children less than 8 years of age shall be kept away unless continuously supervised.

- Never use the product when your judgment or coordination is impaired by the use of alcohol and/or drugs.
- Be careful when using alcoholic drinks in your dishes. Alcohol evaporates at high temperatures and may cause fire since it can ignite when it comes into contact with hot surfaces.
- Do not place any flammable materials close to the product as the sides may become hot during use.
- Keep all ventilation slots clear of obstructions.
- Do not use steam cleaners to clean the appliance as this may cause an electric shock.
- **WARNING:** Unattended cooking on a hob with fat or oil can be dangerous and may result in fire. NEVER try to extinguish a fire with water, but switch off the appliance and then cover flame e.g. with a lid or a fire blanket.
- **CAUTION:** The cooking process has to be supervised. A short term cooking process has to be supervised continuously.
- **WARNING:** Danger of fire: Do not store items on the cooking surfaces.
- **WARNING:** If the surface is cracked, switch off the appliance to avoid the possibility of electric shock.
- In case of hotplate glass breakage : Immediately shut off all burners and any electrical heating element and isolate the appliance from the power supply. Do not touch the appliance surface. Do not use the appliance.
- After use, switch off the hob element by its control and do not rely on the pan detector.
- Metallic objects such as knives, forks, spoons and lids should not be placed on the hob surface since they can get hot.
- The appliance is not intended to be operated by means of an external timer or separate remote-control system.
- Vapour pressure that build up due to the moisture on the hob surface or at the bottom of the pot can cause the pot to move. Therefore, make sure that the oven surface and bottom of the pots are always dry.

- Hotplates are equipped with "Induction" technology. Your induction hob that provides both time and money savings must be used with pots suitable for induction cooking; otherwise hotplates will not operate. See. *General information about cooking, page 16* , selecting the pots.
- As induction hobs create a magnetic field, they may cause harmful impacts for people who use devices such as insulin pump or pacemaker.
- **WARNING:** Use only hob guards designed by the manufacturer of the cooking appliance or indicated by the manufacturer of the appliance in the instructions for use as suitable or hob guards incorporated in the appliance. The use of inappropriate guards can cause accidents.

Prevention against possible fire risk!

- Ensure all electrical connections are secure and tight to prevent risk of arcing.
- Do not use damaged cables or extension cables.

- Ensure liquid or moisture is not accessible to the electrical connection point.

Intended use

- This product is designed for domestic use. Commercial use will void the guarantee.
- **CAUTION:** This appliance is for cooking purposes only. It must not be used for other purposes, for example room heating.
- The manufacturer shall not be liable for any damage caused by improper use or handling errors.

Safety for children

- **WARNING:** Accessible parts may become hot during use. Young children should be kept away.
- The packaging materials will be dangerous for children. Keep the packaging materials away from children. Please dispose of all parts of the packaging according to environmental standards.
- Electrical products are dangerous to children. Keep children away from the product when it is operating and do not allow them to play with the product.

- Do not place any items above the appliance that children may reach for.

Disposing of the old product

Compliance with the WEEE Directive and Disposing of the Waste Product:



This product complies with EU WEEE Directive (2012/19/EU). This product bears a classification symbol for waste electrical and electronic equipment (WEEE).

This product has been manufactured with high quality parts and materials which can be reused and are suitable for recycling. Do not dispose of the waste product with normal domestic and other wastes at the end of its service life. Take

it to the collection center for the recycling of electrical and electronic equipment. Please consult your local authorities to learn about these collection centers.

Compliance with RoHS Directive:

The product you have purchased complies with EU RoHS Directive (2011/65/EU). It does not contain harmful and prohibited materials specified in the Directive.

Package information

- Packaging materials of the product are manufactured from recyclable materials in accordance with our National Environment Regulations. Do not dispose of the packaging materials together with the domestic or other wastes. Take them to the packaging material collection points designated by the local authorities.

2 General information

Overview

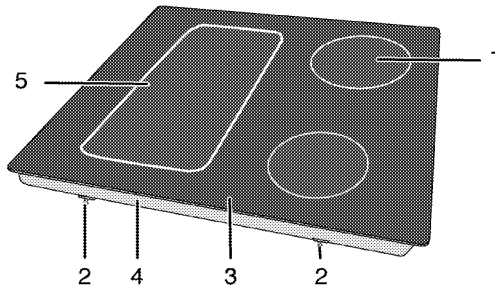

- 1 Induction cooking plate
- 2 Assembly clamp
- 3 Vitroceramic surface
- 4 Base cover
- 5 Induction cooking plate

Technical specifications

Voltage / frequency	1N ~ 220-240 V/ 2N ~ 380-415 V; 50 Hz
Total power consumption	max. 7200 W
Cable type / section	min.H05V2V2-F 5 x 1,5 mm ² or equivalent
External dimensions (height / width / depth)	55 mm/770 mm/510 mm
Installation dimensions (width / depth)	750 (+2) mm/490 (+2) mm
Burners	
Rear left	Induction cooking plate
Dimension	180 mm
Power	1800/3000 W
Front left	Induction cooking plate
Dimension	180 mm
Power	1800/3000 W
Front right	Induction cooking plate
Dimension	145 mm
Power	1500/2200 W
Rear right	Induction cooking plate
Dimension	240 mm
Power	2000/3700 W

i Technical specifications may be changed without prior notice to improve the quality of the product.

i Figures in this manual are schematic and may not exactly match your product.

i Values stated on the product labels or in the documentation accompanying it are obtained in laboratory conditions in accordance with relevant standards. Depending on operational and environmental conditions of the product, these values may vary.

3 Installation

Product must be installed by a qualified person in accordance with the regulations in force. The manufacturer shall not be held responsible for damages arising from procedures carried out by unauthorized persons which may also void the warranty.

i Preparation of location and electrical installation for the product is under installer's responsibility.

! The product must be installed in accordance with all local electrical regulations.

! Prior to installation, visually check if the product has any defects on it. If so, do not have it installed. Damaged products cause risks for your safety.

Before installation

The hob is designed for installation into commercially available work tops. A safety distance must be left between the appliance and the kitchen walls and furniture. See figure (values in mm).

- It can also be used in a free standing position. Allow a minimum distance of 650 mm above the hob surface.
- (*) If a cooker hood is to be installed above the cooker, refer to cooker hood manufacturer' instructions regarding installation height (min 650 mm)
- Remove packaging materials and transport locks.
- Surfaces, synthetic laminates and adhesives used must be heat resistant (100 °C minimum).
- The worktop must be aligned and fixed horizontally.
- Cut aperture for the hob in worktop as per installation dimensions.

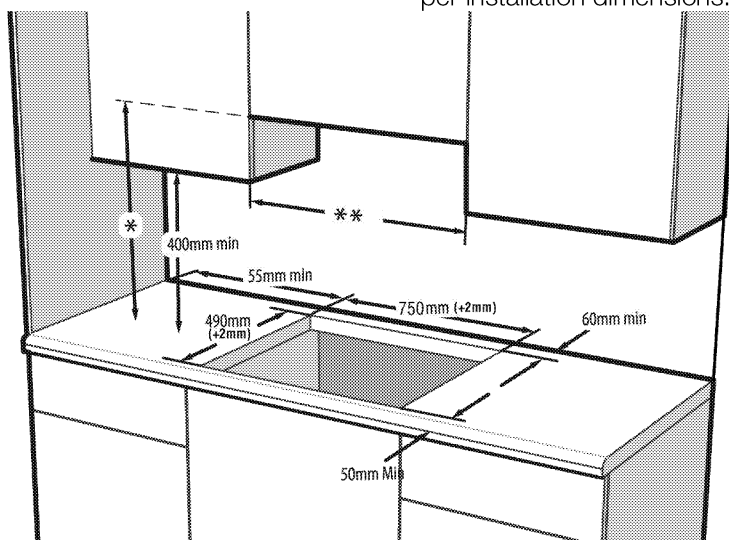

* Minimum height to extractor as recommend in extractor instruction manual

** Minimum distance between cabinetry must be equal to width of hob

Installation and connection

- The product must be installed in accordance with all local gas and electrical regulations.

 Do not install the hob on places with sharp edges or corners. There is the risk of breaking for glass ceramic surface!

Electrical connection

Connect the product to a grounded outlet/line protected by a miniature circuit breaker of suitable capacity as stated in the "Technical specifications" table. Have the grounding installation made by a qualified electrician while using the product with or without a transformer. Our company shall not be liable for any damages that will arise due to using the product without a grounding installation in accordance with the local regulations.

 The product must be connected to the mains supply only by an authorised and qualified person. The product's warranty period starts only after correct installation. Manufacturer shall not be held responsible for damages arising from procedures carried out by unauthorised persons.

 The power cable must not be clamped, bent or trapped or come into contact with hot parts of the product. A damaged power cable must be replaced by a qualified electrician. Otherwise, there is risk of electric shock, short circuit or fire!

- Connection must comply with national regulations.
- The mains supply data must correspond to the data specified on the type label of the product. Type label is at the rear housing of the product.
- Power cable of your product must comply with the values in "Technical specifications" table.

 Before starting any work on the electrical installation, disconnect the product from the mains supply. There is the risk of electric shock!

Connecting the power cable

1. This product must only be connected by a qualified electrician such as a technician from the local electricity company or NICEIC registered contractor to a suitable double-pole control unit with a minimum contact clearance of 3 mm in all poles. This control unit must be installed accordance with the IEE regulation. Failure to obey this instruction may cause operational problems and invalidate the product warranty. Additional protection by a residual current circuit breaker is recommended.

If a cable is supplied with the product:

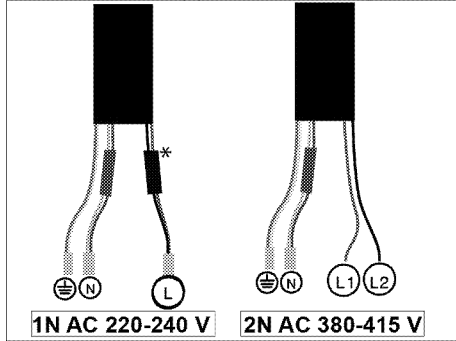

* (This may not exist on your product.)

2. For single-phase connection,

connect the wires as identified below:

- Brown/Black cable = L (Phase)
- Blue/Grey cable = N (Neutral)
- Green/yellow cable = (E) (Ground)

» or

- Grey/Black cable = L (Phase)
- Blue/Brown cable = N (Neutral)
- Green/yellow cable = (E) (Ground)

3. For double-phase connection,

connect the wires as identified below:

- Brown cable = L1 or L2 (Phase 1 or Phase 2)
- Black cable = L2 or L1 (Phase 2 or Phase 1)

- Blue/Grey cable = N (Neutral)
 - Green/yellow cable = (E) (Ground)
- » or

- Black cable = L1 (Phase 1)
- Grey cable = L2 (Phase 2)
- Blue/Brown cable = N (Neutral)
- Green/yellow cable = (E) (Ground)

Installing the product

If the oven is below:

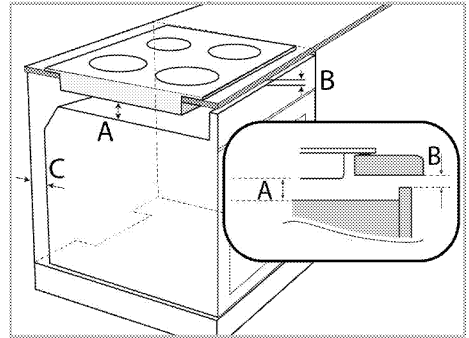

A min. 15 mm

B min. 2 mm

C 20 mm

If the board is below:

It is required to leave a ventilation opening at the rear section of the furniture as illustrated in the following figure.

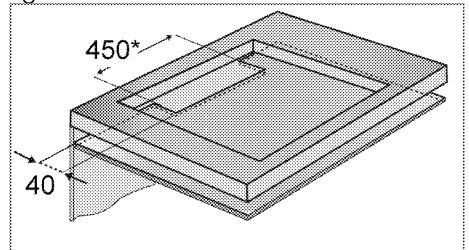

* min.

During installation of your induction hob, place the product parallel to the installation surface. Also, apply sealing gasket to the parts of the hob contacting the counter as described below in order to prevent any liquid from penetrating between the product and the counter.

1. Prepare the surface of the counter as shown in the figure.
2. Turning the hob upside down, place it on a flat surface.
3. When installing the hob, apply the sealing gasket, which was provided in

the packaging, around the hob as shown in the following picture, ensuring that it remains 1 to 2 mm inside from the outer edge of the glass.

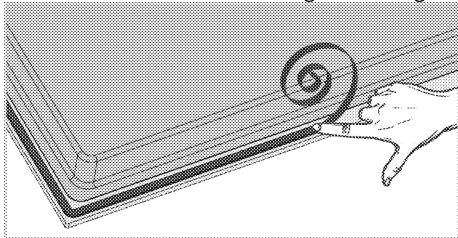

4. Fix the mounting springs inserting and screwing them through the holes of the bottom case as shown in the figure.

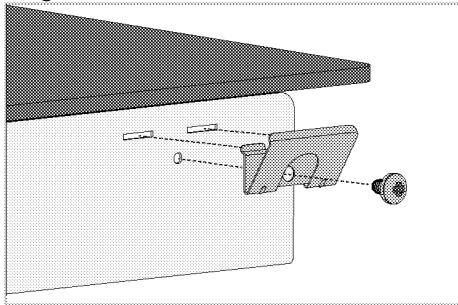

i For some models, your product may come with the mounting springs already fitted on it.

i The number of mounting springs on your product varies depending on product model.

5. Place the hob on the counter and align it.

6. When the hob is placed on the counter top it will be fixed easily with the help of the clamps. If the installation with these clamps is not sufficient for your cooktop, additional 2 mounting clamps can be fixed to the front side of the product as shown in the below figure.

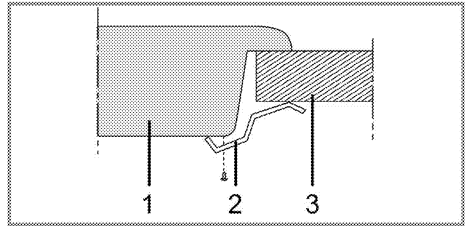

- 1 Hob
- 2 Installation clamp
- 3 Counter

i When installing the hob onto a cabinet, a shelf must be installed in order to separate the cabinet from the hob as illustrated in the above figure. This is not required when installing onto a built-under oven.

For example, if it is possible to touch the bottom of the product since it is installed onto a drawer, this section must be covered with a wooden plate.

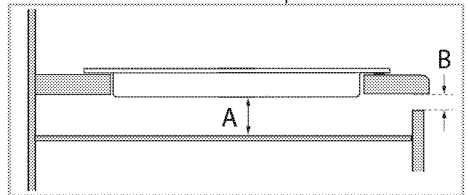

A min. 15 mm

B min. 2 mm

Rear view (connection holes)

i Location of the connection holes shown in the below figure are schematic, may vary depending on the product model. Fix them according to connection holes on your product.

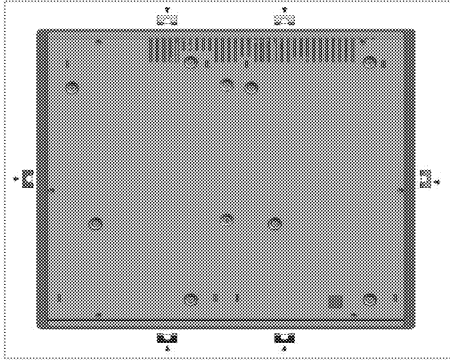

! Making connections to different holes is not a good practice in terms of safety since it can damage the gas and electrical system.

! There are gas and electrical components contained within this hob, therefore when fitting the mounting springs/clamps only attach the supplied fixings to the connection holes shown in this manual. Failure to observe this advice may lead to life and property safety

i The number of mounting springs on your product varies depending on product model.

Final check

1. Operate the product.
2. Check the functions.

Future Transportation

- Keep the product's original carton and transport the product in it. Follow the instructions on the carton. If you do not have the original carton, pack the product in bubble wrap or thick cardboard and tape it securely.
- i** Check the general appearance of your product for any damages that might have occurred during transportation.

4 Preparation

Tips for saving energy

The following information will help you to use your appliance in an ecological way, and to save energy:

- Defrost frozen dishes before cooking them.
- Use pots/pans with cover for cooking. If there is no cover, energy consumption may increase 4 times.
- Select the burner which is suitable for the bottom size of the pot to be used. Always select the correct pot size for your dishes. Larger pots require more energy.
- Pay attention to use flat bottom pots when cooking with electric hobs. Pots with thick bottom will provide a better heat conduction. You can obtain energy savings up to 1/3.
- Vessels and pots must be compatible with the cooking zones. Bottom of the vessels or pots must not be smaller than the hotplate.

- Keep the cooking zones and bottom of the pots clean. Dirt will decrease the heat conduction between the cooking zone and bottom of the pot.

Initial use

First cleaning of the appliance

i The surface might get damaged by some detergents or cleaning materials.

Do not use aggressive detergents, cleaning powders/creams or any sharp objects during cleaning. Do not use harsh abrasive cleaners or sharp metal scrapers to clean the oven door glass since they can scratch the surface, which may result in shattering of the glass.

1. Remove all packaging materials.
2. Wipe the surfaces of the appliance with a damp cloth or sponge and dry with a cloth.

5 How to use the hob

General information about cooking



Never fill the pan with oil more than one third of it. Do not leave the hob unattended when heating oil. Overheated oils bring risk of fire. **Never attempt to extinguish a possible fire with water!**

When oil catches fire, cover it with a fire blanket or damp cloth. Turn off the hob if it is safe to do so and call the fire department.

- Before frying foods, always dry them well and gently place into the hot oil. Ensure complete thawing of frozen foods before frying.
- Do not cover the vessel you use when heating oil.
- Place the pans and saucepans in a manner so that their handles are not over the hob to prevent heating of the handles. Do not place unbalanced and easily tilting vessels on the hob.
- Do not place empty vessels and saucepans on cooking zones that are switched on. They might get damaged.
- Operating a cooking zone without a vessel or saucepan on it will cause damage to the product. Turn off the cooking zones after the cooking is complete.
- As the surface of the product can be hot, do not put plastic and aluminum vessels on it. Clean any melted such materials on the surface immediately. Such vessels should not be used to keep foods either.
- Use flat bottomed saucepans or vessels only.

- Put appropriate amount of food in saucepans and pans. Thus, you will not have to make any unnecessary cleaning by preventing the dishes from overflowing.

Do not put covers of saucepans or pans on cooking zones.

Place the saucepans in a manner so that they are centered on the cooking zone. When you want to move the saucepan onto another cooking zone, lift and place it onto the cooking zone you want instead of sliding it.

Saucepan selection

- Glass ceramic surface is heatproof and is not affected by big temperature differences.
- Do not use the glass ceramic surface as a place of storage or as a cutting board.
- Use only the saucepans and pans with machined bottoms. Sharp edges create scratches on the surface.

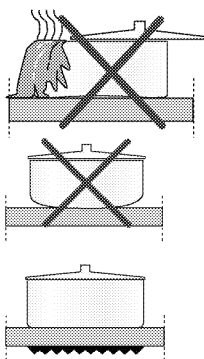

Spills may damage the glass ceramic surface and cause fire.

Do not use vessels with concave or convex bottoms. Use only the saucepans and pans with flat bottoms. They ensure easier heat transfer.

Boiling behavior may vary depending on the pot types, size of the pot and size of the cooking zone. For a more homogenous boiling behavior a one step larger cooking zones might be used. To

use a larger cooking zone has no negative effect on energy consumption at induction hobs, because the heat is only created in relevant pot area.

For induction hobs, use only vessels suitable for induction cooking.

Saucepan test

Use following methods to test whether your saucepan is compatible with the induction hob or not.

1. Your saucepan is compatible if its bottom holds a magnet.
2. Your saucepan is compatible if "L" symbol does not flash when you place your saucepan on a cooking zone.

Only ferromagnetic pans can be used for induction cooking

Ferromagnetic materials include:

- * Enameled steel
- * Cast iron
- * Stainless steel designed for induction cooking

Non-ferromagnetic materials include:

These types of pans will not work with induction cooking.

- * Stainless steel
- * Glass
- * Ceramic
- * Copper or aluminum pans

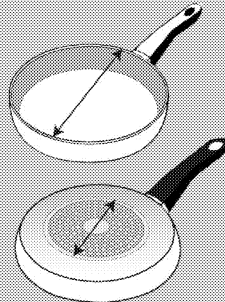
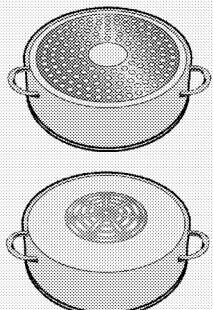
	<p>Some saucepans have a smaller ferromagnetic area than the real diameter of the saucepans. Only this area will be heated up by the induction zone, therefore the cooking performance may be reduced. These pan types cannot be detected by bigger induction zones. The diameter of pan's ferromagnetic area should match the size of the cooking zone. If the pan is not detected by the cooking zone, try it on the next smaller cooking zone.</p>
	<p>Some vessels have a base which includes non-ferromagnetic materials such as aluminum. These types of vessels cannot be detected by the induction zone.</p>

You can use steel, teflon or aluminium saucepans with special magnetic bottom that contains labels or warnings indicating that the saucepan is compatible with induction cooking. Glass and ceramic

vessels, pots and the stainless steel vessels with non-magnetic aluminium bottom should not be used.

Saucepan recognition-focusing system

In induction cooking, only the area covered by the vessel on the relevant cooking zone is energised. The vessel's bottom is recognised by the system and only this area is heated automatically. Cooking stops if the cooking vessel is lifted from the cooking zone during cooking. Selected cooking zone and "L" symbol flashes alternately.

Safe use

Do not select high heating levels when you will use a non-sticking (teflon) saucepan with no oil or with very little oil.

Do not put metal items such as forks, knives or saucepan covers onto your hob since they can get heated. Never use aluminium foil for cooking. Never place food items wrapped with aluminium foil onto the cooking zone.

i If there is an oven under your hob and if it is running, sensors of the hob can decrease the cooking level or turn off the oven.

i When the hob is running, keep items with magnetic properties such as credit cards or cassettes away from the hob.

Selecting cooking zone suitable to the vessel

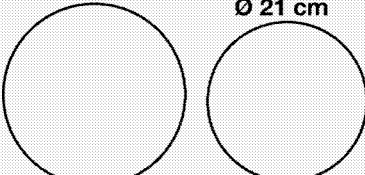
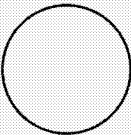
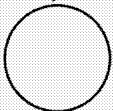
Large cooking zone	Normal cooking zone	Small cooking zone
<p style="text-align: center;">Ø 24 cm Ø 21 cm</p> 	<p style="text-align: center;">Ø 18 cm</p> 	<p style="text-align: center;">Ø 14,5 cm</p> 
<p>Large cooking zone</p> <ul style="list-style-type: none"> • Choose the correct pan size for the surface cooking area. The diameter of the pan's base should correspond to the size of the surface cooking area. * Distributes the power ideally. * Provides perfect heat distribution. Used to cook dishes such as large crepes or large fishes rare or very rare. 	<p>Normal cooking zone</p> <ul style="list-style-type: none"> • Choose the correct pan size for the surface cooking area. The diameter of the pan's base should correspond to the size of the surface cooking area. * Distributes the power ideally. * Provides perfect heat distribution. Used for all kinds of cookings. 	<p>Small cooking zone</p> <ul style="list-style-type: none"> • Choose the correct pan size for the surface cooking area. The diameter of the pan's base should correspond to the size of the surface cooking area. * Used for slow cookings (sauces, creams) * Used to prepare small portions or portions based on number of persons.

Using pots on the wide surface cooking zone

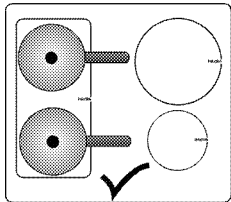

You can use the wide surface cooking zone in two halves separately as rear left and front left cooking zones. Location of the wide surface cooking zone may vary depending on the product model.

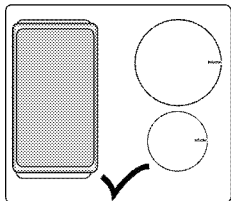

You can use the wide surface cooking zone for large pots.

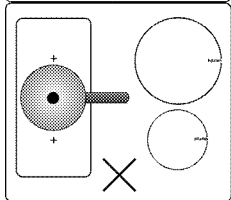

Your pot must cover both centers of the wide surface cooking zone. Do not use the cooking zone in other ways.

Illuminated cooking areas(This may not exist on your product.)

Cooking zones on the hob will be illuminated. The cooking zones will not appear when the hob is in the turned-off or stand-by position. When you turn on the hob, the illumination that indicates the cooking zones should appear.

Using the hobs



Do not allow any object to drop on the hob. Even small objects such as a saltshaker may damage the hob.

Do not use cracked hobs. Water may leak through these cracks and cause short circuit.

In case of any kind of damage on the surface (eg., visible cracks), switch off the product immediately to minimize the risk of electric shock.

Control panel

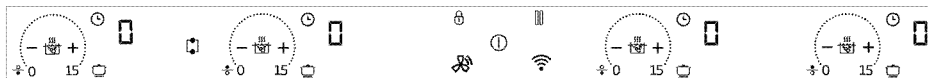

Specifications



Setting area (for temperature level)



On/Off key



Key lock key



Timer



Activation/Deactivation key
Rapid Heating key/High power setting (Booster) key
Automatic cooking key



Stop key



Wide Surface Cooking Zone Selection key *



Timer level increasing key



Timer level decreasing key



Hob to Hood symbol *



Wifi Symbol *

*(This feature is optional. It may not exist on your product.)

i Graphics and figures are for informational purposes only. Actual displays and functions may vary according to the model of your hob.

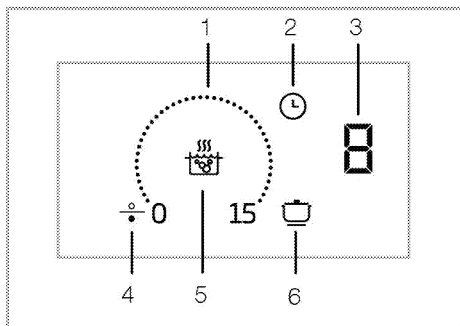

1 Setting area

2 Timer key

3 Cooking zone display

4 Cooking zone symbol (*)

5 Rapid heating key

6 Automatic cooking key

* (Varies depending on the product model.)

i This product is controlled by means of a touch control panel. Each operation you make on your touch control panel will be confirmed by an audible signal.

i Always keep the control panel clean and dry. Having damp and soiled surface may cause problems in the functions.

Turning on the hob

1. Touch the "⏻" key on the control panel.

The hob is ready for use.

i If no operation is performed within 20 seconds, the hob will automatically return to Standby mode.

i When any key ("⏻" key) is pressed for a long time, the product automatically turns off for safety reasons.

Turning off the hob

1. Touch the "⏻" key on the control panel.

The hob will turn off and return to Standby mode.

- i** If "H" or "h" symbol is lit on the cooking zone display once the hob is turned off, it means that the cooking zone is still hot. Do not touch cooking zones.

Residual heat indicator

If "H" symbol is lit on the cooking zone display, it means that the cooking zone is still hot and may be used to keep a small amount of food warm. This symbol will soon turn to "h" symbol meaning less hot.

- i** When the electricity is cut off, residual heat indicator will not light up and does not warn the user against hot cooking zones.

Turning on the cooking zones

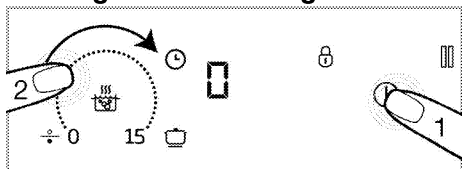

1. Touch the "⏻" key to turn on the hob.
 - » "0" symbol on cooking zone displays.
2. Touch the setting area of the cooking zone you want to switch on and slide your finger across the area.

- i** If no operation is performed within 20 seconds, the hob will automatically return to Standby mode.

Setting the temperature level

By touching the adjustment area or by sliding your finger across the area, adjust the temperature level between "0" and "15".

Turning off the cooking zones:

A selected cooking zone can be turned off in 2 different ways:

1. **By dropping the temperature to "0" level**

You can turn the cooking zone off by dropping the temperature setting to "0" level.

2. **By using the switch-off function on the timer for the desired cooking zone**

When the time is over, the timer will switch off the cooking zone linked to it. "0" or "00" value will appear on all displays. The "⏻" symbol on the hob display will disappear.

When the time is over, an audible alarm will sound. Touch any button on the control panel to silence the audible alarm.

Turning on the wide surface cooking zone (This feature is optional. It may not exist on your product.)

1. Touch the "⏻" key to turn on the hob.
2. Touch Wide Surface Cooking Zone Selection key
 - » 0 will be displayed on the display of the front left cooking zone and "□" symbol will appear on the same display.

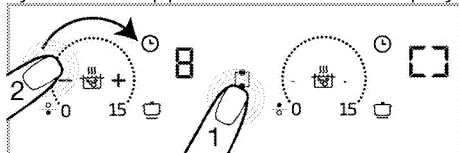

3. By touching the adjustment area or by sliding your finger across the area, adjust the temperature level between 0 and 15.
 - » You can change the temperature level on the setting area of both cooking zones.

- i** Wide surface left cooking zones are explained as an example. If there is a wide surface cooking zone also on the right-hand side of the hob, the same instructions apply to the said cooking zone.

Turning on the wide surface cooking zone while one or both of the left cooking zones are running (This feature is optional. It may not exist on your product.)

While one or both of the left cooking zones are running, you can combine both cooking zones by activating the wide surface cooking zone. Thus, you can utilize a wider cooking zone just with the same values.

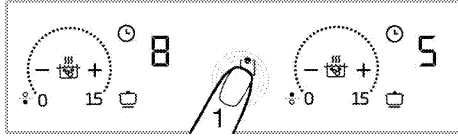

1. Touch the wide surface cooking zone selection key while one or both of the left cooking zones is/are running.

» The smaller one of the temperature values of the cooking zones you have previously selected will appear on the front left cooking zone display. If there is a timer duration given, the timer value of the cooking zone with the lower value will appear on the display.

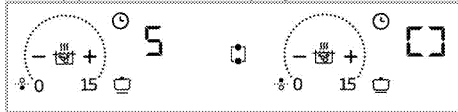

» To change the temperature value afterwards, set the desired temperature on the setting area of both cooking zones.

i If you touch the wide surface zone key while the wide surface cooking zone is active, the cooking zones will be separated and turn off.

Turning off the wide surface cooking zone: (This feature is optional. It may not exist on your product.)

Wide surface cooking zone can be turned off in 3 different ways:

1. By dropping the temperature to "0" level

You can turn the wide surface cooking zone off by dropping the temperature level to "0".

2. By using the turn-off with the timer option for the wide surface cooking zone

When the time is over, the timer will turn off the wide surface cooking zone. **0** will appear on the left cooking zone display and **00** will appear on the timer display. The light of "0" key on the rear left cooking zone display will go off.

3. By touching the wide surface cooking zone symbol for 3 seconds

If you touch the wide surface cooking zone symbol for 3 seconds, the cooking zone is turned off

Models with Illuminated around cooking zones: (This may not exist on your product.)

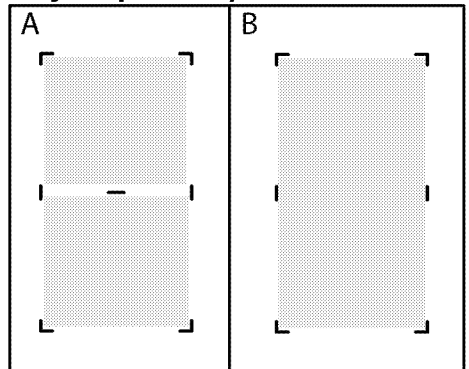

i When the two separate cooking zones (shown in the figure A) are combined as a wide surface cooking zone shown in the figure B, the separating light should go off. When the wide surface cooking zone is returned back into two separate cooking zones, the separating light should be illuminated.

High power setting (BOOSTER)

You can use booster function to perform heating at the maximum power.

However, this function is not recommended for cooking a long time. Booster function may not be available in all cooking zones. When the booster setting time (see, Table of operation time limits) is over, cooking zone will switch off.

Selecting BOOSTER directly:

1. Touch the "⓪" key to turn on the hob.
2. Touch the "🔥" key.

The cooking zone that has been activated will run with maximum power and the animated booster symbol "≡" will appear on the cooking zone display.
» When the booster setting time (see, Table of operation time limits) is over, cooking zone will switch off.

Selecting the booster while the cooking zone is operating:

1. While the hob is on and the respective cooking zone is active, touch "🔥".

i The booster may only be activated in one of the zones on the same side (left or right). If one of the cooking zones on the same side is operating at a certain temperature level, the booster cannot be set for the other cooking zone on the same side. While the large cooking zone is active, the booster cannot be set for these cooking zones.

2. Selected cooking zone will operate at the maximum power and 3 lights will flash on the cooking zone display respectively. Once the Booster period is over, the cooking zone switches to the set temperature level and only the selected temperature value is displayed.

Switching off the high power setting (BOOSTER) prematurely:

By touching the "🔥" key you can turn off the booster setting any time you want.

Key Lock

You can activate the key lock to avoid changing the functions by mistake **when the hob is operating**.

Activating the key lock

1. Touch "⓪" for 3 seconds to lock the control panel.

If any key is pressed when the key lock is active, the light of the "⓪" key flashes.

i You can activate the key lock in operation mode only. When key lock is activated, only the "⓪" key will be functional. When you touch any other key, the light of the "⓪" key will flash to indicate that the key lock is active.

If you turn the hob off when the keys are locked, the key lock must be deactivated to turn the hob on again.

Deactivating the key lock

1. Keep "⓪" key pressed for 3 seconds. The operation is confirmed with an audible signal. The light of the "⓪" key turns off and the control panel is unlocked.

Timer function

This function makes it easier for you to cook. It will not be necessary to attend the oven for the whole cooking period. Cooking zone will be turned off automatically at the end of the time you have selected.

Activating the timer

1. Touch the "⓪" key to turn on the hob.
2. "0" symbol will appear on cooking zone displays.
3. Increase the level of the cooking zone you want to turn on.

4. Touch "⌚" key to activate the timer. "00" will appear on the display of the relevant cooking zone.

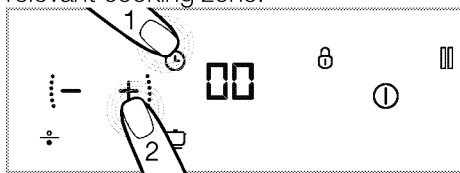

5. Set the desired duration by touching "+" and "-" keys.

» Touch "⌚" to confirm the setting. If you do not touch "⌚", the setting will be cancelled automatically in a few seconds.

i The timer can only be set for the operating cooking zones.

i In order to set the timers of the other cooking zones, repeat the process explained above.

i Timer cannot be adjusted unless the cooking zone and the temperature value for the cooking zone are selected.

Deactivating the timers

Once the set time is over, the hob will be switched off automatically and give an audible warning.

Press any key to silence the audio warning.

Turning off the timers earlier

If you deactivate the timer earlier, the hob will keep on operating at the set temperature until it is switched off.

You can turn the timer off earlier in two different ways:

1-Turning off the timer by dropping its value down to "00" :

1. Select the cooking zone you want to turn off.
2. Touch "⌚" key to select the timer of the relevant cooking zone.
3. Until "00" is displayed on the relevant cooking zone display, decrease the

value by touching the "+" and "-" keys.

2-Deactivating the timer by touching its key for about 3 seconds:

1. Touch "⌚" key of the relevant cooking zone for about 3 seconds; "⌚" will go off completely and the timer will be cancelled.

Automatic cooking function

You can cook quickly at 3 different levels by means of this function.

1. Warm keeping
2. Boiling
3. Frying

Activating the automatic cooking function without setting the timer

1. Touch the "⌚" key to turn on the hob.
2. Touch the "☑" key of the cooking zone on which you want to activate the automatic cooking function.
3. The relevant cooking zone will be activated at the keeping warm level after the first touch. "P" and "☑" symbol will appear on the display.
4. The relevant cooking zone will be activated at the boiling level after the second touch. "P" and "☑" symbol will appear on the display.
5. The relevant cooking zone will be activated at the frying level after the third touch. "P" and "☑" symbol will appear on the display.

» The cooking zone will start to operate at the set automatic cooking level.

Activating the automatic cooking function by setting the timer

1. Select the desired automatic cooking level by touching the "☑" key of the relevant cooking zone.
2. Touch "⌚" key to activate the timer.
» "00" and "⌚" symbols will light on the cooking zone display.
3. Set the desired duration by touching the "-" / "+" keys.

» The cooking zone will keep on operating at the selected automatic cooking level throughout the set time period.

» Once the set time is over, the hob will be switched off automatically and give an audible warning. Press any key to silence the audio warning.

Deactivating the automatic cooking function

1. You can completely switch off the relevant cooking zone by touching the "⓪" key to cancel the automatic cooking function.
2. If you want the cooking zone to operate at a certain level and deactivate the automatic cooking function, set the desired temperature level by touching the "—" / "+" keys. The cooking zone will keep on operating at the set temperature level. If the timer has been set previously, the set cooking time will not be canceled and will keep on at the set temperature level.

Stop function

You can stop all functions (except for the timer) operating on the hob by means of this function.

i If the timer is set for any cooking zone, timer will continue operating during stoppage.



1. Touch the "⏏" key when your hob is operating. All active cooking zones will continue to operate at the minimum level.
2. Touch "⏏" key again to restart all stopped cooking zones with previous settings.

i When the stop key is pressed, "⏏" symbol will appear on the displays of the cooking zones which were active before this key is pressed.

Using the induction cooking zones safely and effectively

Operating principles: Induction hob heats directly the cooking vessel as a feature of its operating principles. Therefore, it has various advantages when compared to other hob types. It operates more efficiently and the hob surface does not heat up. Your induction hob is equipped with superior safety systems that will provide you maximum safe usage.

i Your hob can be equipped with induction cooking zones with a diameter of 145, 180, 210 and 280 mm depending on the model. Each cooking zone automatically detects the vessel placed on it thanks to the induction feature. Energy builds up only where the vessel contacts with the cooking zone and thus, minimum energy consumption is achieved.

Operation time limits

The hob control is equipped with an operation time limit. When one or more cooking zones are left on, the cooking zone will automatically be deactivated after a certain period of time (see, Table-1). If there is a timer assigned to the cooking zone, the timer display will also turn off later.

Operation time limit depends on the selected temperature level. Maximum operation time is applied at this temperature level.

The cooking zone may be restarted by the user after it is turned off automatically as described above.

Table-1: Operation time limits

Temperature level	Operation time limit - hour
0	0
1	6
2	6
3	5
4	5
5	4
6	4
7	3
8	3
9	2
10	2
11	1
12	1
13	1
14	0,5
15	0,5
Rapid Heating	10 minutes
P1	5
P2	2
P3	1

Overheating protection

Your hob is equipped with some sensors ensuring protection against overheating. Following may be observed in case of overheating:

- Active cooking zone may be turned off.
- Selected level may drop. However, this condition cannot be seen on the indicator.

Overflow safety system

Your hob is equipped with a safety system to prevent overflows. If there is overflowing that affects the control panel, the system will turn off the hob by disconnecting the power automatically. Meanwhile, "E" will be displayed.

Precise power setting

Induction hob reacts the commands immediately as a feature of its operating principles. It changes the power settings

very fast. Thus, you can prevent a cooking pot (containing water, milk and etc.) from overflowing even if it was just about to overflow.

Noisy operation



Some noises may arise from the induction hob. These sounds are normal and a part of induction cooking.

- Sound becomes prominent in high temperature levels.
- Alloy of the cooking pot can cause noise.
- In low levels, a regular on/off sound can be heard because of the operating principles.
- Noise can be heard if an empty cooking pot is heated. When you put water or meal in it, this sound will clear away.
- The noise of the fan that cools the electronic system can be heard.

Error messages

Table-2: Error codes and error causes

Error cause	Indicator	Display
Two or more keys are pressed	"E" will flash.	Cooking zone display
Hob is overheated	"H" symbol blinks	Cooking zone display
No saucepan suitable for the cooking zone	"  " symbol lights up.	Cooking zone display
Touch control card hardware error	"Fx**" will turn on	Timer display
Induction hardware error	"Ex**" symbol blinks	Cooking zone display
Pan/pot or another object on the touch control board	"F" symbol blinks	All cooking zone displays
x**: "1,2,...,9"		

-  If the surface of the touch control panel is subjected to vapor, entire control system will be deactivated, a signal sound will be heard and "E" will flash on the display.
-  Keep the surface of the touch control panel clean. It may give erroneous operation warning.
-  No pots/pans must be placed on the touch control panel.

-  For more information about the descriptions of error messages that may appear on the touch control panel, please refer to Table 2. If Fx,Ex or EH errors cannot be corrected, please call the authorised service agent.

6 Maintenance and care

General information

Service life of the product will extend and the possibility of problems will decrease if the product is cleaned at regular intervals.

 Disconnect the product from mains supply before starting maintenance and cleaning works. There is the risk of electric shock!

 Allow the product to cool down before you clean it. Hot surfaces may cause burns!

- Clean the product thoroughly after each use. In this way it will be possible to remove cooking residues more easily, thus avoiding these from burning the next time the appliance is used.
- No special cleaning agents are required for cleaning the product. Use warm water with washing liquid, a soft cloth or sponge to clean the product and wipe it with a dry cloth.
- Always ensure any excess liquid is thoroughly wiped off after cleaning and any spillage is immediately wiped dry.
- Do not use cleaning agents that contain acid or chloride to clean the stainless or inox surfaces and the handle. Use a soft cloth with a liquid detergent (not abrasive) to wipe those parts clean, paying attention to sweep in one direction.

 The surface might get damaged by some detergents or cleaning materials. Do not use aggressive detergents, cleaning powders/creams or any sharp objects during cleaning. Do not use harsh abrasive cleaners or sharp metal scrapers to clean the oven door glass since they can scratch the surface, which may result in shattering of the glass.

 Do not use steam cleaners to clean the appliance as this may cause an electric shock.

Cleaning the hob

Glass ceramic surface

Wipe the glass ceramic surface (vitroceramic) with cold water, paying attention to leave no residual cleaning agents, and dry with a soft clothing. Residues may cause damage on the glass ceramic surface when using the hob for the next time.

Dried residues on the glass ceramic surface (vitroceramic) should under no circumstances be scraped with hook blades, steel wool or similar tools. Remove calcium stains (yellow stains) with commercially available lime remover or a small amount of lime remover such as vinegar or lemon juice.

If the surface is heavily soiled, apply the cleaning agent on a sponge and wait until it is absorbed well. Then, clean the surface of the hob with a damp cloth.

i Sugar-based foods such as thick cream and syrup must be cleaned promptly without waiting the surface to cool down. Otherwise, glass ceramic surface may get damaged permanently.

Slight color fading may occur on coatings or other surfaces in time. This does not affect the operation of the product.

Color fading and stains on the glass ceramic surface is a normal condition, and not a defect.

7 Troubleshooting

Product emits metal noises while heating and cooling.

- When the metal parts are heated, they may expand and cause noise. >>> *This is not a fault.*

Product does not operate.

- The mains fuse is defective or has tripped. >>> *Check fuses in the fuse box. If necessary, replace or reset them.*
- Product is not plugged into the (grounded) socket. >>> *Check the plug connection.*
- If the display does not light up when you switch the hob on again. >>> *Disconnect the appliance at the circuit breaker. Wait 20 seconds and then reconnect it.*
- Overheat protection is active. >>> *Allow your hob to cool down.*
- The cooking pot is not suitable. >>> *Check your pot.*

symbol appears on the cooking zone display.

- You have not placed the pot on the active cooking zone. >>> Check if there is a pot on the cooking zone.
- Your pot is not compatible with induction cooking. >>> Check if your cooking pot is compatible with induction hob.
- The cooking pot is not centered properly or the bottom surface of the pot is not wide enough for the cooking zone. >>> Choose a pot wide enough and center the pot on the cooking zone properly.
- Cooking pot or cooking zone is overheated. >>> Allow them to cool down.

Selected cooking zone suddenly turns off during operation.

- Cooking time for the selected cooking zone may be over. >>> You may set a new cooking time or finish cooking.
- Overheat protection is active. >>> Allow your hob to cool down.
- An object may be covering the touch control panel. >>> Remove the object on the panel.

The pot does not get warm even if the cooking zone is on.

- Your pot is not compatible with induction cooking. >>> Check if your cooking pot is compatible with induction hob.
- The cooking pot is not centered properly or the bottom surface of the pot is not wide enough for the cooking zone. >>> Choose a pot wide enough and center the pot on the cooking zone properly.

-  Consult the Authorised Service Agent or technician with licence or the dealer where you have purchased the product if you can not remedy the trouble although you have implemented the instructions in this section. Never attempt to repair a defective product yourself.

8 Guarantee Details

BLOMBERG UK AND IRELAND STANDARD MANUFACTURER GUARANTEE TERMS AND CONDITIONS

Your new Blomberg product is guaranteed against faulty materials, defective components or manufacturing defects.

The standard guarantee starts from the date of original purchase of the product, and lasts for a period of thirty six (36) months unless Beko plc (the “Manufacturer”) agrees to extend the guarantee for the product in writing.

If you have any questions about the guarantee on your product (including how long it is valid), please contact your retailer or our contact centre on **0333 207 9870** (UK and Northern Ireland) or **01 691 0160** (Republic of Ireland)

This guarantee does not in any way diminish or affect your statutory rights in connection with the product. This guarantee is in addition to your statutory rights as a consumer. If you have any questions about these rights, please contact the retailer from which you purchased the product. In certain circumstances, it is possible that your statutory rights may offer additional or higher levels of protection than those offered under the terms of this guarantee.

What is covered by this guarantee?

- Repairs to the product required as a result of faulty materials, defective components or manufacturing defects.
- Functional replacement parts to repair a product.
- The costs of a Blomberg Approved Engineer to carry out the repair.

What is not covered?

- Transit and delivery damage.
- Cabinet or appearance parts, including but not limited to control knobs, flaps and handles.
- Accessories and/or consumable items including but not limited to ice trays, scrapers, cutlery baskets, filters and light bulbs.
- Repairs necessary as a direct or indirect result of:
 - Accidental damage, misuse or abuse of a product.
 - An attempted repair of a product by anyone other than a Blomberg Approved Engineer (the “Engineer”).
 - Installation or use of a product where such installation or use fails to meet the requirements contained in this guarantee or the User Instructions Booklet.
- Repairs to a product operated at any time on commercial or non-residential household premises (unless we have previously agreed to the installation environment).

This guarantee is limited to the cost of repairing the product. To the extent permitted by law, the Manufacturer does not accept and will not be held liable for any financial loss incurred in connection with the failure of any product to operate in accordance with the expected standards. Such financial loss includes but is not limited to loss arising from:

- Time taken off work.
- Damaged food, clothing or other items.
- Meals taken at restaurants or from takeaways.
- General compensation for inconvenience.

Important Notes

1. Your product is designed and built for domestic household use only.
2. The guarantee will automatically be void if the product is installed or is used in commercial or non-residential domestic household premises, unless we have previously agreed to the installation environment.
3. The product must be correctly installed, located and operated in accordance with the instructions contained in the User Instructions Booklet provided with your product.
4. Professional installation by a qualified Electrical Domestic Appliance Installer is recommended for all Washing Machines, Dishwashers and Electric Cookers (as incorrect installation may result in you having to pay for the cost of repairing the product).
5. Gas Cookers must be professionally installed by a Gas Safe (or Gas Networks Ireland for Republic of Ireland) registered gas installer.
6. This guarantee is given in respect of products purchased and used within the United Kingdom and the Republic of Ireland.
7. This guarantee is effective from the initial date of purchase of a new product from an authorised retailer and will be void if the product is resold.
8. This guarantee does not apply to graded sales (where the product is purchased as a "second").
9. Possession of a copy of these terms and conditions does not necessarily mean that a product has the benefit of this guarantee. If you have any questions, please call our Call Centre on the number set out above.
10. The Manufacturer reserves the right to terminate the guarantee if its staff or representatives are subjected to physical or verbal abuse in the course of carrying out their duties.
11. Optional extras, where available (i.e. extendable feet) are supplied on a chargeable basis only.

Does Blomberg offer replacements?

This is a repair-only guarantee. On occasion, the Manufacturer may at its sole discretion, replace your product with a new product instead of carrying out a repair. Where a replacement is offered, this would normally be an identical model but when this is not possible, a model of similar specification will be provided. The Manufacturer will cover the costs and arrange for the delivery of the new product and for the return of the old product. Any costs related to disconnecting the faulty product and installing the replacement product will not be borne by the Manufacturer unless previously agreed to in writing. The original guarantee will continue to apply to the replacement product; the new product will not come with a new guarantee.

When will the repair take place?

Our Engineers work Monday to Friday 9.00am to 5.00pm. Appointments outside these hours may be possible at the sole discretion of the Manufacturer but cannot be guaranteed. Whilst our Engineers will endeavour to minimize inconvenience and to meet requests for specific timed appointments, this cannot be guaranteed. We will not be liable for delays or if it is unable to carry out a repair because a convenient appointment cannot be arranged.

Will there be any charge for the repairs?

It is your responsibility to provide evidence to the Engineer that your product is covered by this guarantee with a proof of purchase. The Manufacturer reserves the right to charge for the reasonable cost of any service call if:

- You cannot provide evidence that your product is covered by this guarantee.
- Where a service call has been made and the engineer finds that there is no fault with your product.
- That your product has not been installed or operated in accordance with the User Instructions Booklet.
- That the fault was caused by something other than faulty materials, defective components or manufacturing defects.
- For missed appointments.

Payment of these costs are due immediately upon the Engineer providing you with an invoice. The Manufacturer reserves the right to terminate the guarantee if you fail to pay the costs for the service call in a timely manner.

If you are a resident of the United Kingdom, this guarantee will be governed by English law and subject to the English Courts, save where you live in another part of the United Kingdom, in which case the law and courts of that location will apply.

If you are resident in the Republic of Ireland, this guarantee will be governed by Irish law and the Irish courts will have jurisdiction.

This guarantee is provided by Beko plc. Beko House, 1 Greenhill Crescent, Watford, Hertfordshire. WD18 8QU.

Beko plc is registered in England and Wales with company registration number 02415578.

BLOMBERG UK AND IRELAND OPTIMA INVERTER MOTOR GUARANTEE TERMS AND CONDITIONS

This 10 year guarantee relates to Blomberg products that feature the Optima Inverter Motor.

The Optima Motor guarantee terms and conditions are in addition to our Standard guarantee terms and conditions detailed in the previous section.

In order to activate the 10 year guarantee you MUST register the appliance within 90 days of the original purchase date. You can register by first visiting blomberguk.com/register and by following the online instructions.

All Blomberg appliances come with a 3 year parts and labour guarantee as standard. When you register your appliance for the Optima Inverter Motor 10 year guarantee, you are also registering your appliance for the standard 3 year parts and labour guarantee.

Blomberg built-in or integrated products purchased from Euronics agents come with a 3 year parts and labour guarantee which is extended to 5 years, free of charge, upon registration of the appliance. When you register your appliance for this additional 2 years, you will automatically activate the Optima Inverter Motor 10 year guarantee. You do not need to register twice. To make a claim against your Blomberg Optima Inverter Motor Guarantee (the “Guarantee”), all customer and product details must be registered with Beko plc using the procedure outlined below.

1. This extra 7 years or 5 years (for built-in appliances from Euronics agents) Guarantee is only effective after the expiration of the standard manufacturer’s guarantee.
2. It is only valid for the Optima Inverter motors of selected washing machines, washer-dryers, tumble dryers and dishwashers. It does not cover any labour charge or any other components of the product. In addition, it is only valid for one replacement of the Optima motor during the extra 9-year (for free standing appliances) or 8 year (for built-in appliances) guarantee period.
3. To activate your guarantee, you MUST register your appliance within 90 days of the original purchase date, by visiting blomberguk.com/register.
4. Customers will receive a unique reference code as proof of guarantee validation by email or post, which must be quoted at the time of a claim being made.
5. Any repair/replacement of the Optima Inverter motor must only be carried out by an authorised Blomberg Service Agent (the “Service Agent”).

6. Labour for the repair/replacement of the Optima Inverter motor is not included in this guarantee and is chargeable directly by the Service Agent.
7. Any additional components fitted to the product at any time will not be covered by this guarantee and will be chargeable directly by the Service Agent.
8. The guarantee is not transferable and cannot be exchanged for cash.
9. There are no alternative or additional offers to this Guarantee.
10. The guarantee is exclusive of the manufacturer's standard guarantee
11. The Terms and Conditions shown above are in addition to the standard terms and conditions of your product guarantee. Please read and refer to such Terms and Conditions when making any claim.
12. We may use the information you provide for marketing purposes and to analyse your purchasing preferences. We may keep your information for a reasonable period for these purposes in accordance with the applicable Data Protection Laws and General Data Protection Regulations (GDPR). You can opt into this service during the registration process. Further details are available at <http://www.blomberguk.com/cookie-and-privacy>.
13. These Terms and Conditions are governed by the laws of England and Wales; manufacturer: Beko plc, Beko House, 1 Greenhill Crescent, Watford WD18 8QU. Company Registration Number: 02415578.

HOW TO OBTAIN SERVICE FOR YOUR APPLIANCE

Please keep your purchase receipt or other proof of purchase details in a safe place; you will need to have this documentation available should the product require attention under guarantee.

Please take a few moments to complete the details below, as you will need this information when you call us, or to use our online services. When you call us you may be required to input your serial number into your telephone keypad. For help please visit Blomberguk.com/support/model-finder

- The product model number is printed on the Operating Instruction Booklet / User guide
- The product model and serial number is printed on the Rating Label affixed to the appliance.
- The Retailer (Purchased from) and Date of purchase will be printed on your purchase receipt or other proof of purchase paperwork

Recording of these details alone will not count as proof of purchase. A valid proof of purchase is required for requesting service under guarantee.

Model number	Serial number	Purchased from	Date of purchase

For service under guarantee or for product advice please call our Contact centre

Before requesting service please check the troubleshooting guide in the Operating Instructions booklet, as a charge may be levied where no fault is found, and even though your product may still be under guarantee.

After arranging service the area around the product must be easily accessible to the Engineer, without the need for cabinets or furniture to be removed or moved.

It is your responsibility to ensure our Engineers have a clean and safe environment to carry out any repairs.

Please have your Model number and Serial number available when you call us, as you may be required to input your serial number into your telephone keypad during your call.

UK Mainland & Northern Ireland:

0333 207 9870

Landline or mobile calls to 0333 numbers cost no more than calls to geographic numbers 01 or 02, and are charged at the basic rate. Calls from landlines and mobiles are included in free call packages but please check with your telephone service provider for exact call charges.

Republic of Ireland:

01 691 0160

Service once the manufacturers guarantee has expired

If you have purchased an extended guarantee please refer to the instructions contained within the extended guarantee agreement document, otherwise please call us using the appropriate number above, where service can be obtained at a charge.

Should you experience any difficulty in obtaining service please call us on **0333 207 9870** or **01 691 0160**

Contact us through our website

Send us a secure message through our online contact us form. Please visit our website, click Contact Us and choose a product support topic from the list of options. Complete the required details and click send message.

Product registrations

For UK and Republic of Ireland product registrations please visit blomberguk.com/register

