



Microwave Oven

User Manual



MOF 21220 BCP

EN

CONTENTS

1 Important safety and environmental instructions 4

1.1 Safety warnings	4
1.2 Compliance with WEEE Directive and Disposing of the Waste Product	9
1.3 Compliance with RoHS Directive	10
1.4 Package Information	10
1.5 Plug Wiring.....	10

2 Your microwave oven 11

2.1 Overview	11
2.2 Technical data	11

3 Installation 12

4 Operation 13

4.1 Control panel.....	13
4.2 Before cooking.....	13
4.3 Microwave function.....	13
4.4 Defrost.....	14
4.5 Auto cooking.....	15
4.6 Reheat.....	15
4.7 Stop	16
4.8 Start/+30s.....	16
4.9 Express	16
4.10 Child lock function	16

5 Cooking tips 17

6 Cleaning 18

6.1 Microwave oven care	18
6.2 Tips for cleaning.....	18
6.3 Storage.....	19

7 Utensils guideline 19



Please read this manual first!

Dear Customer,

Thank you for purchasing a Beko product. We hope that you get the best results from your product which has been manufactured with high quality and state-of-the-art technology. Therefore, please read this entire user manual and all other accompanying documents carefully before using the product and keep it as a reference for future use. If you handover the product to someone else, give the user manual as well. Follow all warnings and information in the user manual.

Meanings of the symbols

Following symbols are used in the various section of this user manual:

	Important information and useful hints about usage.
	Warnings for dangerous situations concerning the safety of life and property.
	Warning for hot surfaces.



This product has been manufactured in environmental friendly modern plants without giving any harm to the nature.

1 Important safety and environmental instructions

Important Safety Instructions Read Carefully And Keep For Future Reference

1.1 Safety warnings

This section contains safety instructions that will help protect from risk of fire, electric shock, exposure to leak microwave energy, personal injury or property damage. Failure to follow these instructions shall void any warranty.

- Beko Microwave Ovens comply with the applicable safety standards; therefore, in case of any damage on the appliance or power cable, it should be repaired or replaced by the dealer, service center or a specialist and authorized service alike to avoid any danger. Faulty or unqualified repair work may be dangerous and cause risk to the user.
- This appliance is intended to be used in household and similar applications such as:
 - Staff kitchen areas in shops, offices and other working environments;
 - Farm houses
 - By clients in hotels, and other residential type environments;
 - Bed and Breakfast type environments.
- It is not intended for industrial or laboratory use.
- Do not attempt to start the oven when its door is open; otherwise you may be exposed to harmful microwave energy. Safety locks should not be disabled or tampered with.
- The microwave oven is intended for heating food and beverages. Drying of food or clothing and heating of warming pads, slippers, sponges, damp cloth and similar may lead to risk of injury, ignition or fire.

1 Important safety and environmental instructions

- Do not place any object between the front side and the door of the oven. Do not allow dirt or cleaning agent remnants to build up on the closure surfaces.
- Any service works involving removal of the cover that provides protection against exposure to microwave energy must be performed by authorized persons/service. Any other approach is dangerous.
- Your product is intended for cooking, heating and defrost food at home. It must not be used for commercial purposes.
- Your oven is not designed to dry any living being.
- Do not use your appliance to dry clothes or kitchen towels.
- Do not use this appliance outdoors, bathrooms, humid environments or in places where the it can get wet.
- No responsibility or warranty claim shall be assumed for damages arising from misuse or improper handling of the appliance.
- Never attempt to dismantle the appliance. No warranty claims are accepted for damage caused by improper handling.
- Only use the original parts or parts recommended by the manufacturer.
- Do not leave this appliance unattended while it is in use.
- Always use the appliance on a stable, flat, clean dry, and non-slip surface.
- The appliance should not be operated with an external clock timer or separate remote control system.
- Before using the appliance for the first time, clean all parts. Please see the details given in the “Cleaning and Maintenance” section.
- Operate the appliance for its intended purpose only as described in this manual.

1 Important safety and environmental instructions

- Appliance becomes very hot while it is in use. Pay attention not to touch the hot parts inside the oven.
- Do not operate the oven empty.
- Cooking utensil may get hot due to the heat transferred from the heated food to the utensil. You may need oven gloves to hold the utensil.
- Utensils shall be checked to ensure that they are suitable for use in microwave ovens.
- Do not place the oven on stoves or other heat generating appliances. Otherwise, it may be damaged and the warranty becomes void.
- Steam may come out while opening the covers or the foil after cooking the food.
- The appliance and its accessible surfaces may be very hot when the appliance is in use.
- Door and outer glass may be very hot when the appliance is in use.
- Make sure that your mains power supply complies with the information supplied on the rating plate of the appliance.
- The only way to disconnect the appliance from the power supply is to remove the power plug from the power outlet.
- Use the appliance with a grounded outlet only.
- Never use the appliance if the power cable or the appliance itself is damaged.
- Do not use this appliance with an extension cord.
- Never touch the appliance or its plug with damp or wet hands.
- Place the appliance in a way so that the plug is always accessible.
- Prevent damage to the power cable by not squeezing, bending, or rubbing it on sharp edges. Keep the power cable away from hot surfaces and naked flame.

1 Important safety and environmental instructions

- Make sure that there is no danger that the power cable could be accidentally pulled or that someone could trip over it when the appliance is in use.
- Unplug the appliance before each cleaning and when the appliance is not in use.
- Do not pull the power cable of the appliance to disconnect it from its power supply and never wrap its power cable around the appliance.
- Do not immerse the appliance, power cable, or power plug in water or any other liquids. Do not hold it under running water.
- When heating food in plastic or paper containers, keep an eye on the oven due to the possibility of ignition.
- Remove the wire strings and/or metal handles of paper or plastic bags before placing bags to the oven.
- If smoke is observed, switch off or unplug the appliance if safe to do so and keep the door closed in order to stifle any flames.
- Do not use microwave oven for storage. Do not leave paper items, cooking material or food inside the oven when it is not being used.
- The contents of feeding bottles and baby food jars should be stirred or shaken and the temperature checked before consumption, in order to avoid burns.
- This appliance is a Group 2 Class B ISM equipment. Group 2 contains all ISM (Industrial, Scientific and Medical) equipment in which radio-frequency energy is intentionally generated and/or used in the form of electromagnetic radiation for the treatment of material, and spark erosion equipment.
- Class B equipment is suitable for use in domestic establishments and establishments directly connected to a low voltage power supply network.

1 Important safety and environmental instructions

- Do not use cooking oil in the oven. Hot oil may damage the components and materials of the oven, and it may even cause skin burns.
- Pierce food with thick crust such as potatoes, courgettes, apples and chestnuts.
- Appliance must be placed so that the rear side is facing the wall.
- Before moving the appliance, please secure the turntable to prevent damage.
- Eggs in their shell and whole hard-boiled eggs must not be heated in microwave ovens since they may explode, even after microwave heating has ended.

WARNING: If the door or door seals are damaged, the oven must not be operated until it has been repaired by a competent person.

WARNING: It is hazardous for anyone other than a competent person to carry out any service or repair operation which involves the removal of a cover which gives protection against exposure to microwave energy.

WARNING: Liquids and other foods must not be heated in sealed containers since they are liable to explode.

- The oven should be cleaned regularly and any food deposits removed.
- There should be min 20 cm free space above the top surface of the oven.
- Do not over-cook foods; otherwise, you may cause a fire.
- Do not use chemicals and steam assisted cleaners to clean the appliance.
- Extreme caution is advised when being used near children and persons who are restricted in their physical, sensory or mental abilities.

1 Important safety and environmental instructions

- This appliance can be used by the children who are at the age of 8 or over and by the people who have limited physical, sensory or mental capacity or who do not have knowledge and experience, as long as they are supervised with regard to safe use of the product or they are instructed accordingly or understand the risks of using the product. Children should not play with the appliance. Cleaning and user maintenance procedures should not be performed by children unless they are controlled by their elders.
- Danger of choking! Keep all the packaging materials away from children.
- Due to excessive heat that arises in grill and combination modes, children should only be allowed to use these modes under supervision of an adult.
- Keep the product and its power cable so that they are inaccessible by children under 8 years old.
- Do not cook food directly on the glass tray. Put the food in / on appropriate kitchen utensils before placing them in the oven.
- Metallic containers for food and beverages are not allowed during microwave cooking. Otherwise, sparking may occur.
- This product is not designed to be built-in. Do not place the product in a cabinet or box while it is in use.

1.2 Compliance with WEEE Directive and Disposing of the Waste Product

This product complies with EU WEEE Directive (2012/19/EU). This product bears a classification symbol for waste electrical and electronic equipment (WEEE).



This symbol indicates that this product shall not be disposed with other household wastes at the end of its service life. Used device must be returned to official collection point for recycling of electrical and electronic devices. To find these collection systems please contact to your local authorities or retailer where the product was purchased. Each household performs important role in recovering and recycling of old appliance. Appropriate disposal of used appliance helps prevent potential negative consequences for the environment and human health.

1 Important safety and environmental instructions

1.3 Compliance with RoHS Directive

The product you have purchased complies with EU RoHS Directive (2011/65/EU). It does not contain harmful and prohibited materials specified in the Directive.

1.4 Package Information



Packaging materials of the product are manufactured from recyclable materials in accordance with our National Environment Regulations. Do not dispose of the packaging materials together with the domestic or other wastes. Take them to the packaging material collection points designated by the local authorities.

1.5 Plug Wiring

The moulded plug on this appliance incorporates a 13 A fuse. Should the fuse need to be replaced an ASTA approved BS1362 fuse of the same rating must be used. Do not forget to refit the fuse cover. In the event of losing the fuse cover, the plug must not be used until a replacement fuse cover has been fitted. Colour of the replacement fuse cover must be the same colour as that visible on the pin face of the plug. Fuse covers are available from any good electrical store.

• Fitting a different plug

- As the colours of the wires in the mains lead of this appliance may not correspond with the coloured markings identifying the terminals on your plug, proceed as follows:
- Brown cable = L (Live)
- Blue cable = N (Neutral)
- Green/yellow cable must be connected to ground (E) \equiv line

- With the alternative plugs a 13 A fuse must be fitted either in the plug or adaptor or in the main fuse box. If in doubt contact a qualified electrician.

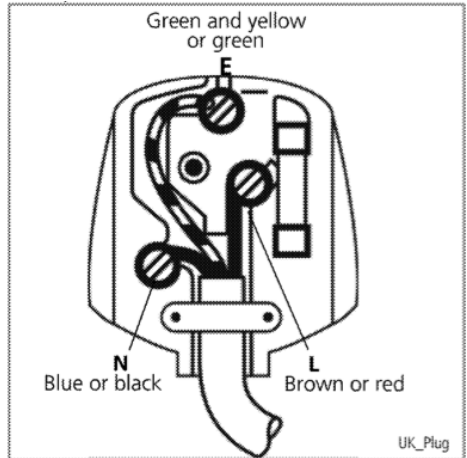

2 Your microwave oven

2.1 Overview

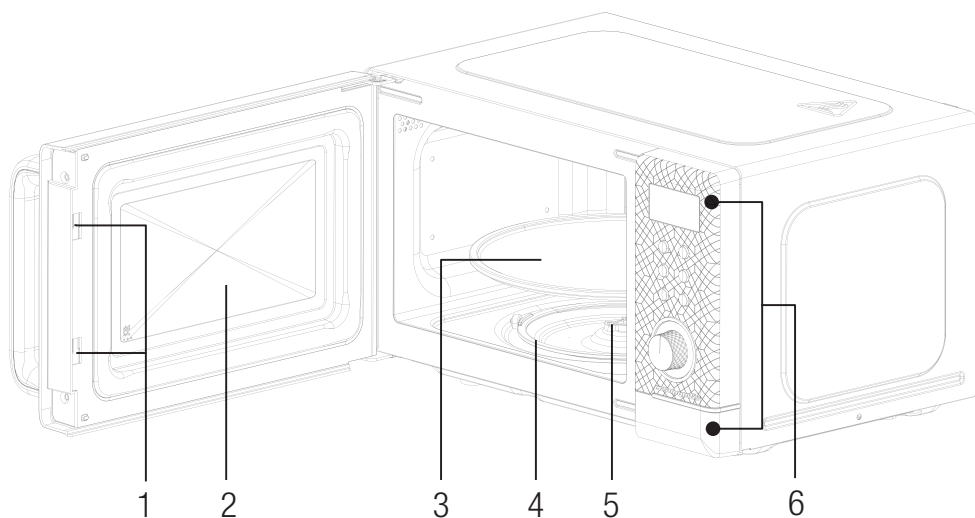

Controls and parts

1. Door lock
2. Viewing window
3. Turntable
4. Rotating ring
5. Rotating axis
6. Control panel

2.2 Technical data

Voltage	230 V~, 50 Hz
Microwave input power	1280 W
Microwave output power	800 W
Microwave frequency	2450 MHz
Turntable diameter	255 mm
External dimensions	373*456*262 mm
Oven capacity	21 L
Net weight	10.7 kg

Technical and design modification rights are reserved.

Markings on the product or the values stated in other documents supplied with the product are values obtained under laboratory conditions as per relevant standards. These values may vary according to the usage of the appliance and ambient conditions. Power values are tested at 230V.

2 Your microwave oven

1. Door lock

Microwave oven door must be properly closed in order for it to operate

2. Viewing window

Allow user to see the cooking status

3. Turntable

The food sits on the turntable, its rotation during operation helps to cook food evenly

4. Rotating ring

The glass turntable sits on its wheels; it supports the turntable and helps it to balance when rotating

5. Rotating axis

The glass turntable sits on the axis; the motor underneath it drives the turntable to rotate



- Place the rotating ring first
- Fit the turntable onto the rotating axis and make sure that it is geared in properly

6. Control panel

See below in details (the control panel is subject to change without prior notice)

7. Waveguide cover

It is inside the microwave oven, next to the wall of control panel.



Never remove the waveguide cover

3 Installation

1. Take out all the packing. If there is a safe film over the oven, tear it off before Use. Check carefully for damage. If any, immediately notify dealer or send to the manufacturer's service center.
2. Microwave ovens must be placed under dry and non-corrosiveness environments, kept away from heat and humidity, such as gas burner or water tank.
3. To ensure sufficient ventilation, the distance of the back of microwave to the wall should be at least 10 cm, the side to the wall should be at least 5 cm, the free distance above the top surface at least 20 cm. the distance of the microwave to the ground should be at least 85 cm.
4. The position of the oven shall be such that it is far from the TV, Radio or antenna as picture disturbance. The distance should be more than 5m.
5. The appliance must be positioned so that the plug is accessible, and must ensure a good grounding in case leakage, ground loop can be formed to avoid electric shock.
6. The microwave oven must be operated with the door closed.
7. The microwave oven must not be placed in a cabinet. The microwave oven is intended to be used freestanding.
8. As there is manufacturing residue or oil remained on the oven cavity or heat element, it usually would smell the odor, even a slight smoke, It is normal case and would not occur after several times use, keep the door or window open to ensure good ventilation. So it is strongly recommended to place a cup of water in the turntable, setting at high power and operate for several times.

4 Operation

4.1 Control panel

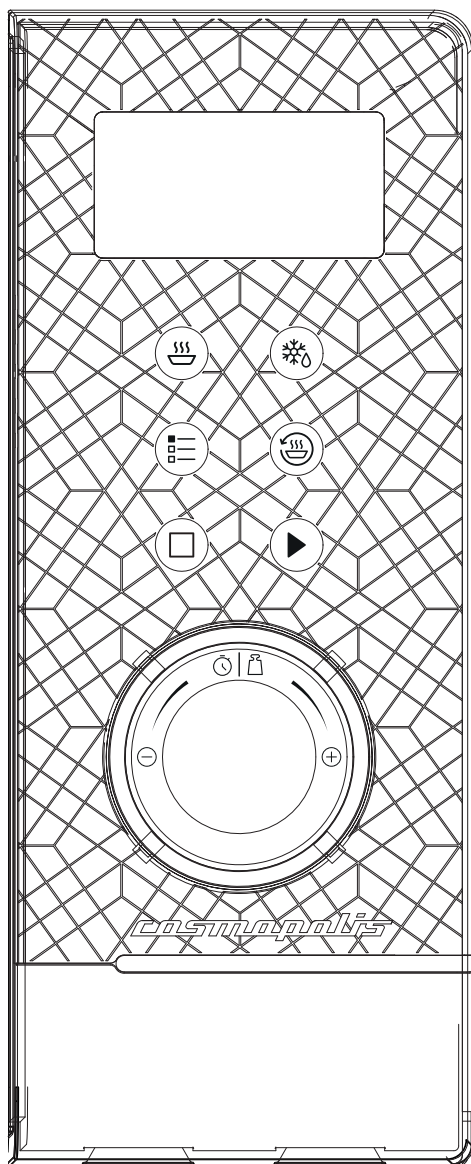

	Microwave function
	Defrost
	Auto cooking
	Reheat
	Stop
	Start/+30s

4.2 Before cooking

The display lit up when plugged in power supply, then enter the standby state and display shows "0:00".

4.3 Microwave function

There are five firepower, 100P, 80P, 50P, 30P and 10P, respectively.

1. Press the "" button continuously and select the desired microwave power.
2. Turn the knob to increase or decrease cooking time, can select the time range is 0:10~60:00.
3. After select the time, press "" button to start work.
4. An buzzing sound to notify completion of the operation.

High	100% power output	Applicable for quick and thorough cooking
M. High	80% power output	Applicable for medium express cooking
Med	50% power output	Applicable for steaming food
M. Low	30% power output	Applicable for defrosting food
Low	10% power output	Applicable for keeping warm

4 Operation



- The max time which can be set is 60 minutes
- Never operate the oven empty.
- At the maximum microwave power, the oven will automatically lower the power after a certain time of cooking to lengthen the service life.
- If you turn the food during operation, press the “▶” button once and the preset cooking procedure will continue.
- If you intend to remove the food before the preset time, you must press “□” button once to clear the preset procedure to avoid unintended operation of next time use.



- It is necessary to turn over the food during operation to obtain uniform effect.
- Usually defrosting will need longer time than that of cooking the food.
- If the food can be cut by knife, the defrosting process can be considered completed.
- Microwave penetrates around 4 cm into most food
- Defrosted food should be consumed as soon as possible, it is not advised to put back to fridge and freeze again.

Example: To cook at P80 for 10 minutes.

	Steps	Display
1	After power-up, the colon flashes	:
2	Select the desired microwave power by pressing “☺” button consecutively	80P
3	Set cooking time by turning knob	10:00
4	Start cooking by pressing “▶” button	

4.4 Defrost

This function use for defrost food. There are two defrost mode, dEF1 and dEF2, respectively. dEF1 for defrost by weight and dEF2 for defrost by time.

dEF1	For defrosting, the weight range from 0.1 to 1.5 kg.
dEF2	For defrosting, the time range from 0:10 to 60:00.

Example: To defrost 0.4kg poultry

	Steps	Display
1	After power-up, the colon flashes	:
2	Press “☼” button to select the defrost mode	dEF1 or dEF2
3	Then turn the knob to chose the food weight or defrost time.	0.4
4	dEF1 selectable option range of weight	100g - 1500g
5	dEF2 selectable option range	0:10 - 60:00
6	Start operation by pressing “▶” button	
7	In half way during defrosting beep sounds will be heard to prompt you turn over the food. Open the door and turn over the food. Then close the door. Press “▶” button again to continue defrosting.	

4 Operation

4.5 Auto cooking

There are fourteen automatic menus from A.1 to A.14.

Choose the appropriate menu according to the food type and weight and strictly observe the directions in below table, otherwise the cooking effect will be largely influenced.



Display	Kind	Method
A.1	Potato	Applicable for the weight range is 250g, 500g and 750g.
A.2	Pasta	Applicable for the weight range is 50g, 100g and 150g.
A.3	Pizza	Applicable for the weight range is 200g and 400g.
A.4	Popcorn	Applicable for the weight range is 100g.
A.5	Vegetable	Applicable for the weight range is 200g, 400g and 600g.
A.6	Beverage	Applicable for the weight range is 1 cup, 2 cups or 3 cups, each one about 250ml.
A.7	Meat	Applicable for the weight range is 200g, 400g and 600g.
A.8	Fish	Applicable for the weight range is 200g, 400g and 600g.
A.9	Rice	Applicable for the weight range is 100g, 200g, 300g, 400g and 500g.
A.10	Chicken	Applicable for the weight range is 200g, 400g and 600g.
A.11	Chocolate	Applicable for the weight range is 50g, 100g and 200g.
A.12	Butter	Applicable for the weight range is 60g, 125g and 250g.

A.13	Keep Warm	Applicable for the weight range is 100g, 200g and 300g.
A.14	Plate Warmer	Applicable for the weight range is 1 plate, 2 plates and 6 plates.



- The temperature of food before cooking would be 20-25 °C. Higher or lower temperature of the food before cooking would require increase or decrease of cooking time.
- The temperature, weight and shape of food will largely influence the cooking effect. If any deviation has been found to the factor noted on above menu, you can adjust the cooking time for best result.

Example: Steam 0.45kg fish

	Steps	Display
1	After power-up, the colon flashes	:
2	Press the  button to enter the menu interface	A.1
3	Turn the knob to select the desired menu, the selection range	A.8
4	Press  button to confirm the current menu	
5	Turn the knob to select the weight of the menu. After selecting the weight and cooking weight, press  button to start work.	

4.6 Reheat

1. Reheat function is mainly to facilitate users to heat food according to the weight of food, press  button continuously, select the appropriate weight of food, the weight range can be selected is 200g, 400g, 600g, 800g and 1000g.

4 Operation

2. After select the weight, press “▶” button to start work.
3. An buzzing sound to notify completion of the operation.

4.7 Stop

In the process of cooking settings, can press “□” button to cancel the settings and return to standby state.

In the process of microwave oven working, can press “□” button to pause.

In the standby state, can press “□” button again to cancel the function and return to standby state.

4.8 Start/+30s

After setting the cooking time or food weight, press the “▶” button to start the microwave oven.

In working state, can press “▶” button to increase time, press one time to increase 30 seconds, but the menu mode and weight defrosting mode can not adjust time.

In pause state, can press “▶” button to continue the microwave oven before cooking mode.

4.9 Express

In standby mode, after food is put in, press “▶” button to start microwave oven quickly.

The default working time is 30 seconds.

In working state, can press “▶” button to increase time, press one time to increase 30 seconds.

An buzzing sound to notify completion of the operation.

4.10 Child lock function

Use this feature to lock the control panel when you are cleaning or so that children can not use the oven unsupervised. All the buttons are rendered inoperable in this mode.

1. **Set lock:** Hold “□” button about 3 seconds.
2. **Cancel lock:** Hold “□” button about 3 seconds.

5 Cooking tips

The following factors may affect the cooking result:

Food arrangement

Place thicker areas towards outside of dish, the thinner part towards the centre and spread it evenly. Do not overlap if possible.

Cooking time length

Start cooking with a short time setting, evaluate it after it times out and extend it according to the actual need. Over cooking may result in smoke and burns.

Cooking food evenly

Food such as chicken, hamburger or steak should be turned once during cooking.

Depending on the type of food, if applicable, stir it from outside to centre of dish once or twice during cooking

Allow standing time

After cooking times out, leave the food in the oven for an adequate length of time, this allows it to complete its cooking cycle and cooling it down in a gradual manner

Whether the food is done

Color and hardness of food help to determine if it is done, these include:

- Steam coming out from all parts of food, not just the edge
- Joints of poultry can be moved easily
- Pork or poultry shows no signs of blood
- Fish is opaque and can be sliced easily with a fork

Browning dish

When using a browning dish or self-heating container, always place a heat-resistant insulator such as a porcelain plate under it to prevent damage to the turntable and rotating ring.

Microwave safe plastic wrap

When cooking food with high fat content, do not allow the plastic wrap come into contact with food as it may melt

Microwave safe plastic cookware

Some microwave safe plastic cookware might not be suitable for cooking foods with high fat and sugar content. Also, the preheating time specified in the dish instruction manual must not be exceeded.

6 Cleaning

6.1 Microwave oven care



The oven should be cleaned regularly and any food deposits removed.

WARNING:

1. Remove the power cord from the wall outlet before cleaning. Don't immerse the appliance in water or other fluids when cleaning.
2. Failure to maintain the oven in a clean condition could lead to deterioration of the surface that could adversely affect the life of the appliance and possibly result in a hazardous situation
3. Never use hard detergent, gas-oil, abrasive powder or metal brush to clean any part of the appliance
4. Do not remove the waveguide cover
5. When the microwave oven has been used for a long time, there may be some strange odors exist in oven, Following 3 methods can get rid of them:
 - Place several lemon slices in a cup, then heat with high Micro Power for 2-3 min.
 - Place a cup of red tea in oven, then heat with high micro power.
 - Put some orange peel into oven, and then heat them with high Micro Power for 1 minute.
6. When the product is not used, it should be placed in try and ventilated areas as well as possible.



WARNING: Only allow children to use the oven without supervision when adequate instructions have been given so that the child is able to use the oven in a safe way and understands the hazards of improper use;

Details how to clean surfaces in contact with food: After use wipe the waveguide cover with a damp cloth, followed by dry cloth to remove any food splashes and grease. Built -up grease may overheat and begin to cause smoke or catch fire.

6.2 Tips for cleaning

Details for cleaning door seals, cavity and adjacent parts:

Exterior:

- Wipe the enclosure with a dampened soft cloth

Door:

- Using a dampened soft cloth, wipe clean the door and window
- Wipe the door seals and adjacent parts to remove any spill or spatter
- Wipe the control panel with a slightly dampened soft cloth

Interior walls:

- Wipe clean the cavity with a dampened soft cloth
- Wipe clean the waveguide cover to remove any food splashed

Turntable/ Rotation ring/ Rotation axis:

- Wash with mild soap water
- Rinse with clean water and allow drying thoroughly

6 Cleaning

6.3 Storage

- If you do not intend to use the appliance for a long time, please store it carefully.
- Please make sure that the appliance is unplugged, cooled down and totally dry.
- Store the appliance in a cool and dry place.
- Keep the appliance out of the reach of children.

7 Utensils guideline

It is strongly recommended to use the containers which are suitable and safe for microwave cooking. Generally speaking, the containers which are made of heat-resistant ceramic, glass or plastic are suitable for microwave cooking. Never use the metal containers for microwave cooking and combination cooking as spark is likely to occur. You can take the reference of below table.

Material of container	Microwave	Notes
Heat-resistant ceramic	Yes	Never use the ceramics which are decorated with metal rim or glazed
Heat-resistant plastic	Yes	Can not be used for long time microwave cooking
Heat-resistant glass	Yes	
Plastic film	Yes	It should not be used when cooking meat or chops as the over-temperature may do damage to the film
Grill rack	No	

Product Guarantee

12 months breakdown and repair guarantee

Guarantor: **Beko plc, 1 Greenhill Crescent, Watford, Hertfordshire. WD18 8UF**

The guarantee does not in any way diminish your statutory or legal rights.

Your **microwave** has the benefit of our manufacturer's guarantee which covers the product for 12 months from the date of original purchase.

This gives you reassurance that if within that time, your **microwave** is proven to be defective because of either workmanship or materials, we will at our discretion either repair or replace your **microwave**.

The **microwave** must be correctly installed, located and operated in accordance with the instructions contained in the user manual. The guarantor disclaims any liability for accidental or consequential damage.

The Guarantee is subject to the following conditions:

- Documentary proof of the original purchase date is provided.
- The microwave has been installed and operated correctly and in accordance with our operating and maintenance instructions.
- The microwave is used only on the electricity supply on the rating plate.
- The microwave has only been used for normal domestic purposes.
- The microwave has not been altered, serviced, dismantled or otherwise interfered with by any person.
- The microwave is used in the United Kingdom or Republic of Ireland.
- Any parts removed during repair work or any product that has been replaced becomes our property.
- The guarantee is not transferrable if the product is resold.

The Guarantee does not cover:

- Transit, installation or delivery damage.
- Accidental damage.
- Misuse or abuse.
- Replacement of any consumable item or accessories. These include but are not limited to: plugs, cables, light bulbs, knobs, filters and flaps.
- Repairs or replacements required as a result of unauthorised repairs or inexpert installation that fails to meet the requirements contained in the user guide or instruction book.
- Repairs to products used in commercial or non-residential household premises.

How to obtain after sales service, help or general advice

Please keep your purchase receipt or other proof of purchase in a safe place as you will need to show us this document if your product requires attention within the guarantee period.

Please also record your product details below, which will allow you to access our services more quickly and help us identify your product. The model number is printed on the front of the user guide and the serial and model number is shown on your products rating plate.

Model number	Serial number	Purchased from	Date of purchase

Please call our UK based Customer Service department if you need help or advice from us:

United Kingdom and Northern Ireland: **0333 207 9710**

Republic of Ireland: **01 862 3411**

You can also contact us through our website: **www.beko.co.uk**

Arçelik A.Ş.
Karaağaç Caddesi No: 2-6, 34445,
Sütlüce, İstanbul, Türkiye

www.beko.com