

BUILT-IN OVEN

OIF 22301 R

BEKO

Please read this manual first.

Dear Customer,

We would like you to obtain best performance with your product that has been manufactured in modern facilities and passed through strict quality control procedures.

Therefore, we advise you to read through this User Manual carefully before using your product and keep it for future reference. If you hand over the product to someone else, deliver the User Manual as well.

The User Manual will help you use the product in a fast and safe way.

- Read the User Manual before installing and starting the product.
- You must strictly observe the safety instructions.
- Keep this User Manual within easy reach for future reference.
- Also read other documents supplied with the product.
Remember that this User Manual may also be applicable for several other models.
Differences between models are explicitly identified in the manual.

Explanation of symbols

Throughout this User Manual the following symbols are used:

 Important information or useful hints about usage.

 Warning for hazardous situations with regard to life and property.

 Warning for electric shock.

 Warning for risk of fire.

 Warning for hot surfaces.

Table of Contents

1	General information	4	5	How to operate the oven	16
	Overview	4		General information on baking, roasting and grilling	16
	Technical specifications	5		How to use the electric oven	16
	Accessories	5		Operating modes	17
2	Safety instructions	7		How to operate the oven timer	18
	General safety	7		How to use the program lock	19
	Safety when working with electricity .	8		How to use the alarm clock	20
	Intended use	8		Cooking times table	21
	Safety for children	8		How to operate the grill	22
3	Installation	9		Cooking times table for grilling	22
	Before installation	9	6	Maintenance and care	23
	Installation and connection	10		General information	23
	Disposal	12		Cleaning the control panel	23
	Disposing of packaging material	12		Cleaning the oven	23
	Disposing of the old product	13		Taking off the door inner glass	23
	Future Transportation	13		Replacing the oven lamp	24
4	Preparation	14	7	Troubleshooting	25
	Tips for saving energy	14	8	Guarantee and Service	26
	Initial operation	14			
	Setting the time	14			
	First cleaning of the appliance	15			
	Initial heating	15			

1 General information

Overview

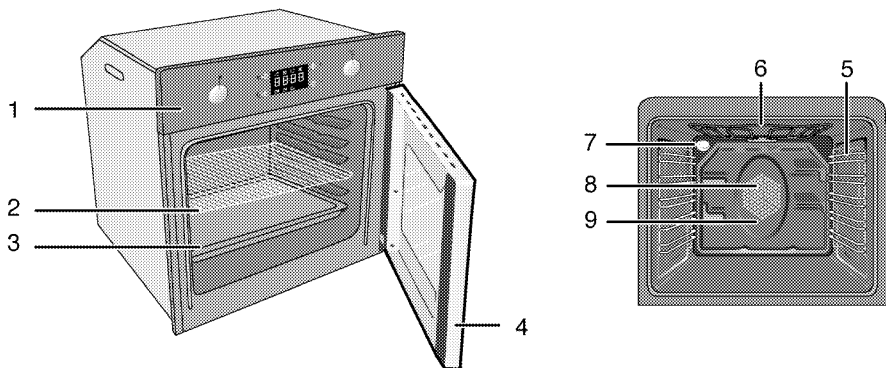

- 1 Control panel
- 2 Wire shelf
- 3 Tray
- 4 Door
- 5 Shelf positions

- 6 Top heating element
- 7 Lamp
- 8 Fan motor (behind steel plate)
- 9 Ring heater

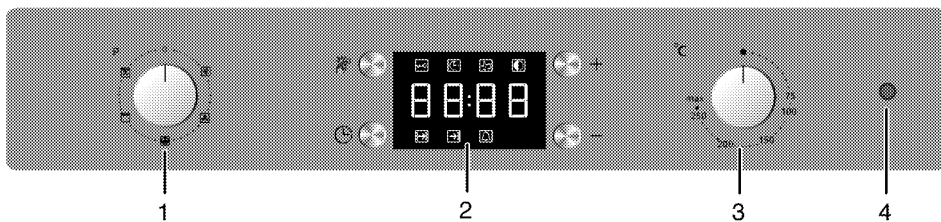

- 1 Function knob
- 2 Digital timer

- 3 Thermostat knob
- 4 Thermostat lamp

Technical specifications

Voltage / frequency	220-240 V ~ 50 Hz
Total power consumption	2.3 kW
Fuse	min. 13 A
Cable type / section	H05VV-FG 3 x 1,5 mm ²
Cable length	max. 2 m
External dimensions (height / width / depth)	595 mm/594 mm/567 mm
Installation dimensions (height / width / depth)	**590 or 600 mm/560 mm/min. 550 mm
Main oven	Fan oven
Energy efficiency class [#]	A
Inner lamp	15/25 W
Grill power consumption	2.2 kW

[#] Basics: Information on the energy label of electrical ovens is given in accordance with the EN 50304 standard. Those values are determined under standard load with bottom-top heater or fan assisted heating (if any) functions.

Energy efficiency class is determined in accordance with the following prioritization depending on whether the relevant functions exist on the product or not. 1-Cooking with eco-fan, 2- Turbo slow cooking, 3- Turbo cooking, 4- Fan assisted bottom/top heating, 5-Top and bottom heating.

** See. *Installation*, page 9.

 Technical specifications may be changed without prior notice to improve the quality of the product.

 Figures in this manual are schematic and may not exactly match your product.

 Values stated on the product labels or in the documentation accompanying it are obtained in laboratory conditions in accordance with relevant standards. Depending on operational and environmental conditions of the product, these values may vary.

Accessories

 Accessories supplied can vary depending on the product model. Not every accessory described in the user manual may exist on your product.

Oven tray

Used for pastries, frozen foods and big roasts.

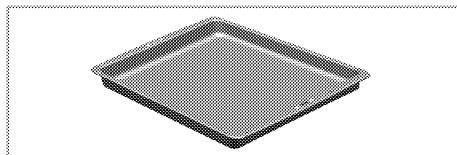

Deep tray

Used for pastries, large roasts, juicy dishes, and for collecting the fat while grilling.

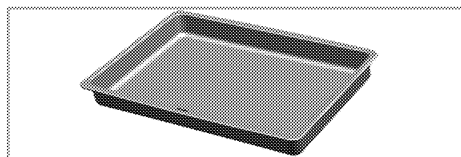

Cake tray

Used for pastries such as cookies and biscuits.

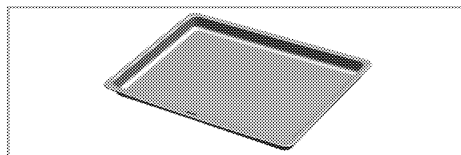

Small oven tray

Used for small portions. This oven tray is placed onto the wire grill.

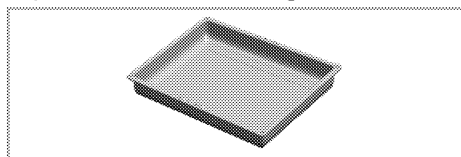

Wire grill

Used for roasting and for placing the food to be baked, roasted or cooked in casserole dishes to the desired rack.

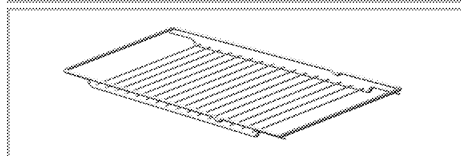
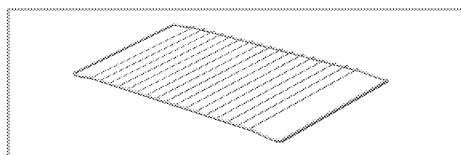

Small wire rack (used with the tray supplied with the product)

It is placed into the tray in order to collect the dripping fat while grilling so that the oven is kept clean.

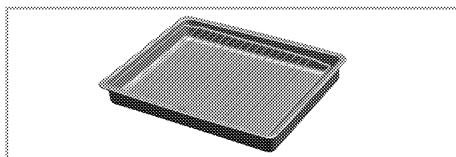

Placing the wire grill and tray onto the telescopic racks properly

Telescopic racks allow you to install and remove the trays and wire grill easily.

When using the tray and wire grill with telescopic racks, make sure that the pins at the rear section of the telescopic rack stands against the edges of the wire grill and tray.

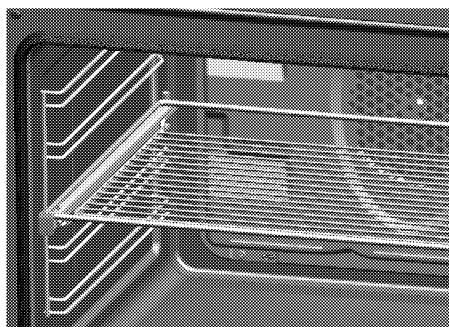
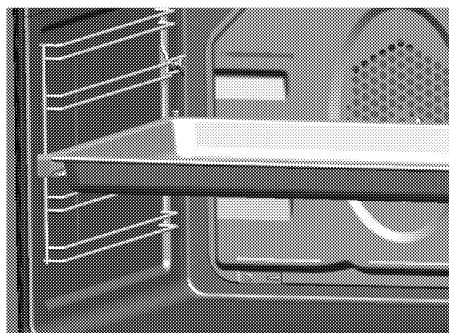

2 Safety instructions

General safety

- This product is not intended to be used by persons with physical, sensory or mental disorders or unlearned or inexperienced people (including children) unless they are attended by a person who will be responsible for their safety or who will instruct them accordingly for use of the product.
Children must be supervised to prevent them from tampering with the product.
- Connect the product to a grounded outlet/line protected by a fuse of suitable capacity as stated in the "Technical specifications" table. Have the grounding installation made by a qualified electrician while using the product with or without a transformer. Our company shall not be liable for any damages that will arise due to using the product without a grounding installation in accordance with the local regulations.
- Do not operate the product if the power cable or plug is damaged. Call Authorised Service Agent.
- Do not operate the product if it is defective or has any visible damage.
- Do not carry out any repairs or modifications on the product. However, you may remedy some troubles that do not require any repairs or modifications. See *Troubleshooting, page 25*.
- Never wash down the product with water! There is the risk of electric shock!
- Never use the product when your judgement or coordination is impaired by the use of alcohol and/or drugs.
- Product must be disconnected from the mains during installation, maintenance, cleaning and repair procedures.
- Installation and repair procedures must always be performed by Authorised Service Agents. Manufacturer shall not be held responsible for damages arising from procedures carried out by unauthorised persons.
- Be careful when using alcoholic drinks in your dishes. Alcohol evaporates at high temperatures and may cause fire since it can ignite when it comes into contact with hot surfaces.
- Do not heat closed tins and glass jars in the oven. The pressure that would build-up in the jar may cause it to burst out.
- Do not place any flammable materials close to the product as the sides become hot during use.
- Do not place baking trays, dishes or aluminium foil directly onto the bottom of the oven. The heat accumulation might damage the bottom of the oven.
- Keep all ventilation slots clear of obstructions.
- Product may be hot when it is in use. Never touch the hot burners,

inner sections of the oven, heaters and etc.

- Always use heat resistant oven gloves when putting and removing dishes into/from the hot oven.
- Do not use the product with front door glass removed or cracked.
- Rear surface of the oven gets hot when it is in use. Make sure that the gas/electrical connection do not contact the rear surface; otherwise, connections can get damaged.
- Do not trap the mains cable between the oven door and frame and do not route it over the hot surfaces. Otherwise, cable insulation may melt and cause fire as a result of short circuit.
- Make sure that the product is switched off after every use.

 Product must be installed by a qualified person in accordance with the regulations in force. Otherwise, the warranty shall become void.

Safety when working with electricity

- Any work on electric equipment and systems may only be carried out by authorized qualified persons.
- Even if the oven is off, the cooling fan continues working for a while after turning off the oven.
- In case of any damage, switch off the appliance and disconnect it from the mains supply by

removing the fuse or switching off the circuit breaker.

- Ensure that the fuse rating is correct.

Intended use

This product is designed for domestic use. Commercial use is not admissible. This product should not be used for warming the plates under the grill, drying towels, dish cloths and etc. by hanging them on the handles and for heating purposes.

The manufacturer shall not be liable for any damage caused by improper use or handling errors.

The oven can be used for defrosting, baking, roasting and grilling food.

Safety for children

- Accessible parts of the appliance will become hot whilst the appliance is in use and until the appliance has cooled, children should be kept away.
- "**CAUTION:** Accessible parts may be hot when the grill is in use. Young children should be kept away."
- The packaging materials will be dangerous for children. Keep the packaging materials away from children. Please dispose of all parts of the packaging according to environmental standards.
- When the door is open, do **not** load any heavy object on it and do **not** allow children to sit on it. It may overturn or door hinges may get damaged.

3 Installation

Before installation

- The appliance is intended for installation in commercially available kitchen cabinets. A safety distance must be left between the appliance and the kitchen walls and furniture. See figure (values in mm). For models with side opening doors, we recommend a side clearance of 60mm between the appliance and any side wall to allow the door to be opened fully.
- Surfaces, synthetic laminates and adhesives used must be heat resistant (100 °C minimum).
- Kitchen cabinets must be set level and fixed.
- If there is a drawer beneath the oven, a shelf must be installed between oven and drawer.
- The following installation drawings are representational and may not match exactly with your appliance.

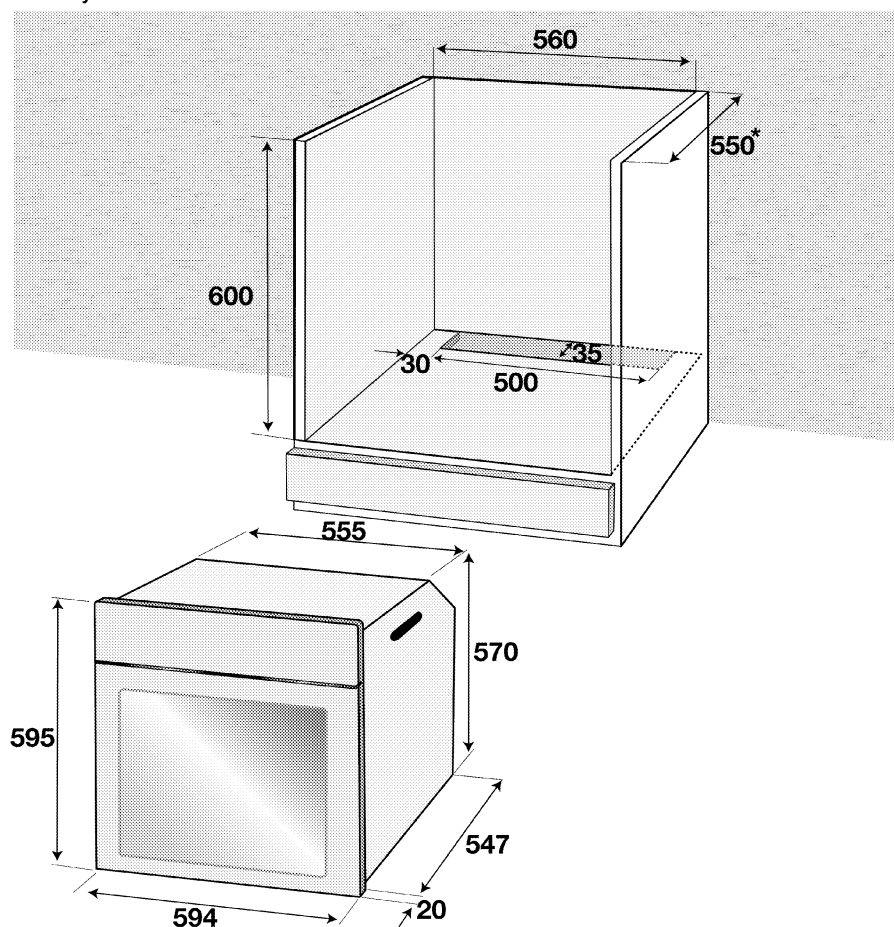

* min.

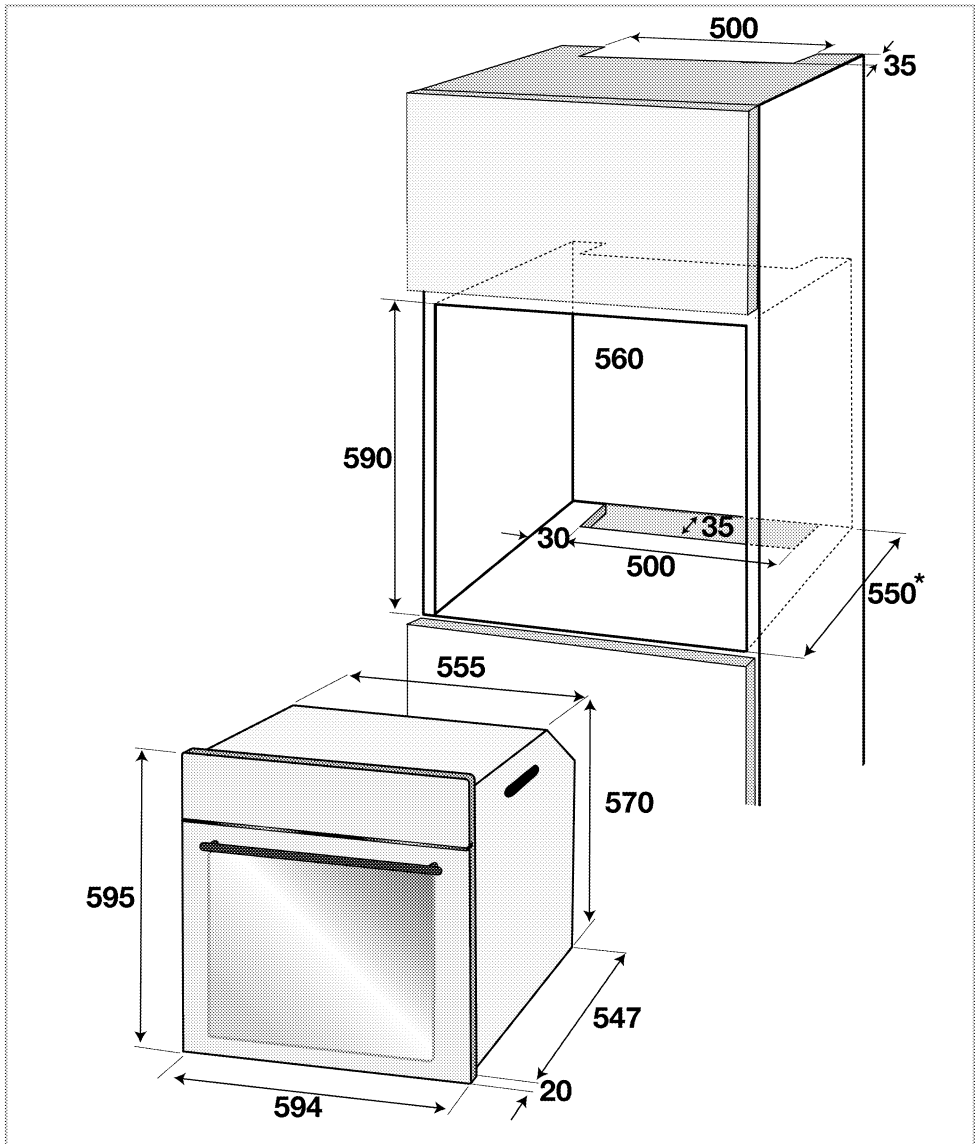

* min.

Installation and connection

ⓘ Material damage!
The door and/or handle must not be used for lifting or moving the appliance.

- For installation the appliance must be connected in accordance with all local gas and/or electrical regulations.
- Carry the appliance with at least two persons.

- Use the slots or wire handles located at both sides to move the appliance.
- ❗ If the appliance has wire handles, push the handles back into the side walls after moving the appliance.

Connection to the mains supply

❗ This appliance must be earthed!

Our company shall not be held responsible for any damage caused by using the appliance without an earthed socket.

- ⚠ Risk of electric shock, short circuit or fire by unprofessional installation!

The appliance may be connected to the mains supply only by an authorized qualified person and the appliance is only guaranteed after correct installation.

- ⚠ Risk of electric shock, short circuit or fire by damage of the mains lead!
- The mains lead must not be clamped, bent or trapped or come into contact with hot parts of the appliance.

If the mains lead is damaged, it must be replaced by a qualified electrician.

- The mains supply must correspond to the data specified on the rating plate of the appliance. The rating plate can be seen when the front door is opened.
- The appliance mains cable must correspond to the specifications

and the power consumption; see *Technical specifications, page 5.*

- ⚠ Risk of electric shock!
Before starting any work on the electrical installation, please disconnect the appliance from the mains supply.

1. This appliance must only be installed by a qualified electrician, eg local electricity company or a NICEIC registered contractor, to a suitable double-pole control unit with a minimum contact clearance of 3 mm in all poles, after appliance has been installed in accordance with IEE regulations. Failure to observe this instruction may result in operational problems and invalidation of the appliance warranty.

Additional protection by a residual current circuit breaker is recommended.

2. Open the terminal block cover with a screwdriver.
3. Pass the mains lead under the cable clamp and secure the cable clamp with the supplied screw.
4. Connect the cables according to the supplied diagram.

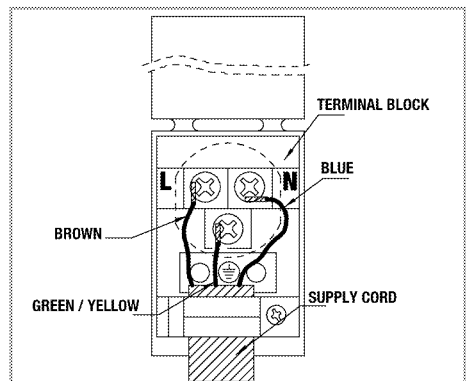

5. Close the cover of the terminal block once the wiring is complete.

i Mains cable must not be longer than 2 meters for safety reasons.

6. The mains lead should be routed away from the appliance and not be trapped between the appliance and the wall.

Installation

1. Slide the oven through the cabinet aperture, align and secure.

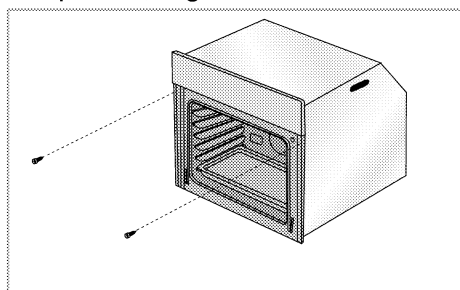

Fix your oven with the 2 screws and washers as indicated in the figure.

Final check

1. Connect the appliance to the mains supply and switch on the mains supply.
2. Check function.

For equipment with a cooling fan

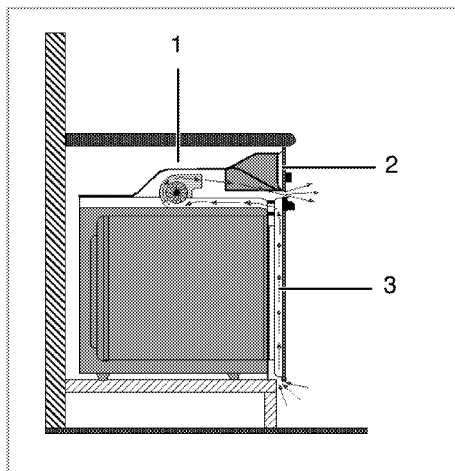

- 1 Fan
- 2 Control panel
- 3 Door

The Built-in cooling fan cools both the built-in cabinet and the front of the appliance.

i Cooling fan continues to run for up to 20-30 minutes (approx.) even after the oven is turned off.

Disposal

Disposing of packaging material

Packaging materials are dangerous to children. Keep packaging materials in a safe place out of reach of children. Packaging materials of the product are manufactured from recyclable materials. Dispose of them properly and sort in accordance with recycled waste instructions. Do not dispose of them with normal domestic waste.

Disposing of the old product





Dispose of the old product in an environmentally friendly manner. This equipment bears the selective sorting symbol for waste electrical and electronic equipment (WEEE). This means that this equipment must be handled pursuant to European Directive 2002/96/EC in order to be recycled or dismantled to minimize its impact on the environment. For further information, please contact local or regional authorities.

Electronic equipments not included in the selective sorting process are potentially dangerous for the environment and human health due to the presence of hazardous substances. Refer to your local dealer or solid waste collection centre in your area to learn how to dispose of your product. Before disposing of the product, cut off the power cable plug and make the

door lock (if any) unusable to avoid dangerous conditions to children.

Future Transportation

- Keep the product's original carton and transport the product in it. Follow the instructions on the carton. If you do not have the original carton, pack the product in bubble wrap or thick cardboard and tape it securely.
- To prevent the wire grill and tray inside the oven from damaging the oven door, place a strip of cardboard onto the inside of the oven door that lines up with the position of the trays. Tape the oven door to the side walls.
- Do not use the door or handle to lift or move the product.
-  Do not place other items on the top of the appliance. The appliance must be transported upright.
-  Check the general appearance of your product for any damages that might have occurred during transportation.

4 Preparation

Tips for saving energy

The following information will help you to use your appliance in an ecological way, and to save energy:

- Use dark coloured or enamel coated cookware in the oven since the heat transmission will be better.
- While cooking your dishes, perform a preheating operation if it is advised in the user manual or cooking instructions.
- Do not open the door of the oven frequently during cooking.
- Try to cook more than one dish in the oven at the same time whenever possible. You can cook by placing two cooking vessels onto the wire grill.
- Cook more than one dish one after another. The oven will already be hot.
- You can save energy by switching off your oven a few minutes before the end of the cooking time. Do not open the oven door.
- Defrost frozen dishes before cooking them.

Initial operation

Before first usage of your appliance, don't forget to remove the sticker on the digital timer screen.

Setting the time

-  Before using the oven the clock time must be set. If the clock time is not set, the oven will not work.

-  While making any adjustment, related symbols on the clock will flash.

After switching on the oven for the first time, adjust the current time with keys 5 and 6.

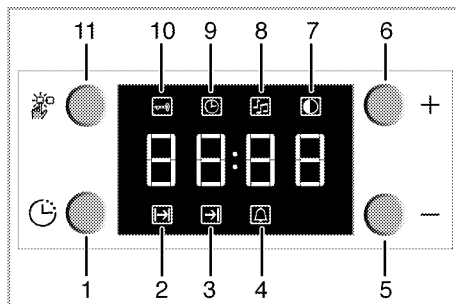

- 1 Program knob
- 2 Cooking time
- 3 Cooking end time
- 4 Alarm period
- 5 Minus key
- 6 Plus key
- 7 Screen brightness adjustment
- 8 Alarm volume
- 9 Current time
- 10 Keylock
- 11 Adjustment key

After setting the time, you can start and end the cooking by selecting the desired position with temperature button and function button.

-  If the current time is not set, time setting will start increasing/moving up from 12:00. Clock icon '9' will be displayed to indicate that the current time has not been set. This icon will disappear once the time is set.

-  Current time settings are cancelled in case of power failure and will need to be set again.

Changing the time of the day

In order to change a preset time of the day in your oven;

1. Press key **11** to activate current time icon '9'.
2. Adjust hour of the day using keys **5** and **6**.

Changing screen brightness adjustment

1. Press key **11** to activate screen brightness symbol '7' for screen brightness adjustment.
2. Adjust the desired brightness using keys **5** and **6**.

» Selected brightness level will be displayed as **d-01**, **d-02** or **d-03** on the screen.

First cleaning of the appliance

-  The surface may get damaged by some detergents or cleaning materials.
Do not use aggressive detergents, cleaning powder/cream or any sharp objects.

1. Remove all packaging materials.
2. Wipe the surfaces of the appliance with a damp cloth or sponge and dry with a cloth.

Initial heating

Heat up the product for about 30 minutes and then switch it off. Thus, any production residues or layers will be burnt off and removed.

-  Hot surfaces may cause burns!
Do not touch the hot surfaces of the appliance. Use oven gloves. Keep children away from the appliance.

Electric oven

1. Take all baking trays and the wire grill out of the oven.
2. Close the oven door.
3. Select the highest grill power; See *How to use the electric oven, page 16*.
4. Operate the oven about 30 minutes.
5. Turn off your oven; See *How to use the electric oven, page 16*

Grill oven

1. Take all baking trays and the wire grill out of the oven.
2. Close the oven door.
3. Select the highest grill power; see *How to operate the grill, page 22*.
4. Operate the oven about 30 minutes.
5. Turn off your grill; see *How to operate the grill, page 22*

-  Smell and smoke may emit during first heating. Ensure that the room is well ventilated.

5 How to operate the oven

General information on baking, roasting and grilling

- ⚠ Risk of scalding by hot steam!
Take care when opening the oven door as steam may escape.

Tips for baking

- Use non-stick coated appropriate metal plates or aluminum containers or heat-resistant silicone moulds.
- Make best use of the space on the rack.
- It is recommended to place the baking mould in the middle of the rack.
- Select the correct shelf position before turning the oven or grill on - don't move oven shelves when hot.
- Keep the oven door closed.

Tips for roasting

- Seasoning with lemon juice and black pepper will improve the cooking performance when cooking a whole chicken, turkey or a large piece of meat.
- Meat with bones takes about 15 to 30 minutes longer before it is cooked than a roast of the same size without bones.
- You should calculate about 4 to 5 minutes cooking time per centimeter height of the meat.
- Let meat rest in the oven for about 10 minutes after the cooking time. The juice is better distributed all over the roast and does not run out when the meat is cut.
- Fish in a fire-resistant dish should be placed on the rack at the medium or lower level.

Tips for grilling

Grilling is ideal for cooking meat, fish and poultry and will achieve a nice brown surface without it drying out too much. Flat pieces, meat skewers and sausages are particularly suited for grilling as are vegetables with a high water content such as tomatoes and onions.

- Distribute the pieces to be grilled on the wire shelf.
- If the grilling is on the wire shelf, locate a dripping pan under it in order to collect the fat.
- Add some water in the dripping pan for easy cleaning.

How to use the electric oven

- ⓘ Before using the oven the clock time must be set. If the clock time is not set, the oven will not work.

Select temperature and operating mode

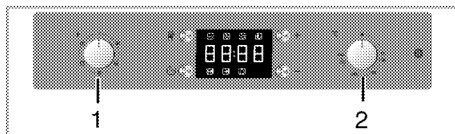

- 1 Function knob
- 2 Thermostat knob

The operating modes of the electric oven are selected with the function knob. The temperature is adjusted with the thermostat knob.

All oven functions are turned off by turning the relevant knob to off (upper) position.

1. Set thermostat knob to the desired temperature.
2. Set function knob to the required operating mode.

» The oven heats up to the adjusted temperature and maintains it. During heating, temperature lamp stays on.

Switch off electric oven

Turn function knob and thermostat knob to off position (top).

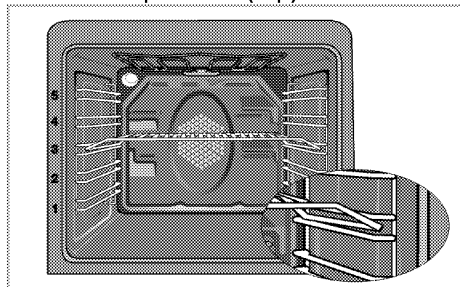

Shelf positions (model dependant)

It is important to position the wire grill on wire shelf correctly. The wire grill must be placed so that it will fit into the opening of the wire shelf as illustrated in the figure.

Operating modes

The order of operating modes shown here might deviate from the arrangement on your appliance.

Oven lamp



The oven is not heated. Only the oven lamp is lit. Possibly also the outside cooling fan is running to prevent cabinets from heat.

Operating with fan



The oven is not heated. Only the fan (in the rear wall) is in operation. Frozen granular food is thawed slowly at room temperature and cooked food is cooled down.

Hot air



The heating ring with fan (in the rear wall) is in operation. The hot air is distributed evenly and quickly all over the oven by the fan. In most cases, preheating is not required. Suitable when several levels are used for the preparation of food. Suitable for cooking with multi trays.

Surface grill



The large grill (under the oven roof) is in operation. Suitable for grilling larger quantities.

- Put big or medium-sized portions in correct shelf position under the grill heater for grilling.
- Set the temperature to maximum level.
- Turn the food after half of the grilling time.

Strong grill with convection air



The large grill (under the oven roof) is in operation. Suitable for grilling larger quantities.

- Put big or medium-sized portions in correct shelf position under the grill heater for grilling.
- Set the temperature to maximum level.
- Turn the food after half of the grilling time.

How to operate the oven timer

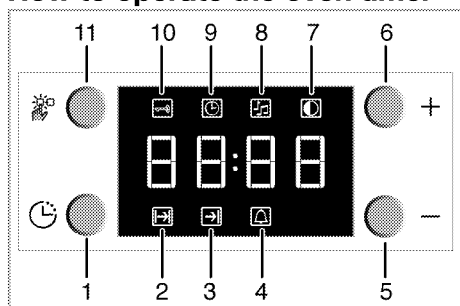

- 1 Program knob
- 2 Cooking time
- 3 Cooking end time
- 4 Alarm period
- 5 Minus key
- 6 Plus key
- 7 Screen brightness adjustment
- 8 Alarm volume
- 9 Current time
- 10 Keylock
- 11 Adjustment key

i The maximum time to be set for the end of the cooking process is 23 hours and 59 minutes. In case of power cut, program will be canceled. Reprogram is needed.

i While making any adjustment, related symbols on the clock will flash. You must wait for a short time for the settings to take effect.

i If semi-automatic or full automatic operation mode is set on the clock, time of the day cannot be adjusted.

i Cooking time will be displayed once the cooking starts.

Switch on fully automatic operation

In this operation mode you may adjust how long the oven will automatically

operate (cooking time) and the time it will be automatically turned off (end of cooking time).

1. Press **1** key to activate cooking time symbol (**2**).
2. Adjust the cooking time using **5** and **6** keys.

» Cooking symbol will be on (will be displayed continuously) after cooking time is set.

3. For the cooking end time, press **1** key to activate cooking end time symbol '**3**'.

4. Adjust cooking end time using **5** and **6** keys.

» Once the cooking end time is set, cooking end symbol and cooking symbol will be lit (displayed continuously). The end of cooking time symbol (**3**) will disappear as soon as the cooking has started.

5. Place your dish in the oven.

6. Select operation mode and temperature.

» Oven timer automatically calculates the startup time for cooking by using the end of cooking time you have set and the cooking period. Selected operation mode is activated when the startup time of cooking has come and the oven is heated up to the set temperature. It maintains this temperature until the end of the cooking time.

7. After the cooking process is completed, "**End**" symbol will be displayed and the alarm signal will sound.

8. Alarm signal will be on for 2 minutes. To stop the alarm signal, just press any key.

- i** If you mute the alarm by pressing any key, the oven will restart operating.
If you press any button at the end of the alarm period, the oven will restart operating.

» Alarm will be silenced and current time will be displayed.

9. **Do not forget** to turn off the oven using temperature knob and function knob.

Switch on semi-automatic operation

In this operation mode, you may adjust the time period during which the oven will operate (cooking time).

1. Press **1** key to activate cooking time symbol '2'.
2. Adjust the cooking time using **5** and **6** keys.

» Cooking symbol shall be on (will be displayed continuously) after cooking time is set.

3. Place your dish in the oven.
4. Select operation mode and temperature.

» The oven will be heated up to the preset temperature and will maintain this temperature until the end of the cooking time you selected.

5. After the cooking process is completed, **"End"** symbol will be displayed and the alarm signal will sound.

6. Alarm signal will be on for 2 minutes. To stop the alarm signal, just press any key.

- i** If you mute the alarm by pressing any key, the oven will restart operating.
If you press any button at the end of the alarm period, the oven will restart operating.

» Alarm will be silenced and current time will be displayed.

7. Do not forget to turn off the oven using temperature knob and function knob.

How to use the program lock

Activate the program lock

You can prevent using of clock buttons by activating the program lock feature.

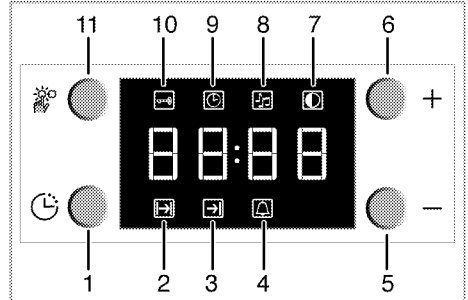

- 1 Program knob
- 2 Cooking time
- 3 Cooking end time
- 4 Alarm period
- 5 Minus key
- 6 Plus key
- 7 Screen brightness adjustment
- 8 Alarm volume
- 9 Current time
- 10 Keylock
- 11 Adjustment key

- i** When the keylock function is activated, clock buttons except for **"11"** key cannot be used.

1. Press **'11'** key to activate keylock symbol **"10"**.
» **"OFF"** will be displayed.
2. Press **6** key to activate the keylock.
» After the keylock has been adjusted, **"ON"** will be displayed and the keylock symbol will stay on.

Deactivate the program lock

1. Press **'11'** key to activate keylock symbol **"10"**.

» **"ON"** will be displayed.

2. Press **'5'** key to deactivate the keylock.

» **"OFF"** will be displayed after the keylock is turned off.

How to use the alarm clock

In addition to using the timer for cooking, it can be also used as a reminder or an alarm clock.

As soon as the defined period of time has expired, the alarm clock will emit a signal. The alarm clock has no influence on the functions of the oven.

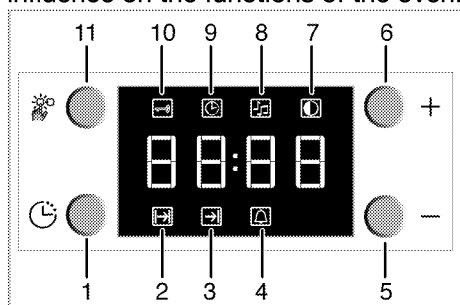

- 1 Program knob
- 2 Cooking time
- 3 Cooking end time
- 4 Alarm period
- 5 Minus key
- 6 Plus key
- 7 Screen brightness adjustment
- 8 Alarm volume
- 9 Current time
- 10 Keylock
- 11 Adjustment key

Setting the alarm clock

1. Press **1** key to activate alarm time symbol **(4)**.

i The maximum alarm time can be 23 hours and 59 minutes.

2. Adjust the alarm time using **5** and **6** keys.

» Alarm symbol will be on (will be displayed continuously) after alarm time is set, and the alarm time will be displayed.

3. After the alarm time is finished, alarm symbol will start flashing and an alarm signal is heard.

Switching off the alarm

1. To stop the alarm signal, just press any key.

» Alarm will be silenced and current time will be displayed.

In order to cancel set alarm time;

1. To reset the alarm time, press **1** key to activate alarm time symbol **(4)**.

2. Press and hold the key **5** until **"0.00"** is displayed.

i Alarm time will be displayed. If the alarm time and cooking time are set concurrently, shortest time will be displayed.

Changing alarm sound adjustment

1. Press **'11'** key to activate alarm sound adjustment symbol **(8)** for alarm volume adjustment.

2. Adjust the desired sound using **'5'** and **'6'** keys.

























» Selected alarm sound level will be displayed as **"b-01"**, **"b-02"** or **"b-03"** on the screen.

Cooking times table

 The values indicated in the table below are data indicative. They may vary according to the type of food as well as your preferences of cooking.

Baking and roasting

 Level 1 is the **bottom** level in the oven.

Food	Cooking level number		Rack position	Temperature (°C)	Cooking time (min.) (approx.)
Cake in tray*	One level		3	175	30 ... 40
	2 levels		1 - 5	175	45 ... 50
Cake in mould*	One level		2	175	50 ... 60
Cakes in paper*	One level		3	175	25 ... 35
	2 levels		1 - 5	175	35 ... 45
	3 levels		1 - 3 - 5	180	45 ... 55
Sponge cake*	One level		3	200	8 ... 15
Cookies*	One level		3	175	25 ... 30
	2 levels		1 - 5	170 ... 190	35 ... 45
	3 levels		1 - 3 - 5	175	30 ... 40
Dough pastry*	One level		3	200	35 ... 45
	2 levels		1 - 5	200	50 ... 60
	3 levels		1 - 3 - 5	200	55 ... 65
Filled savory pastry*	One level		3	200	25 ... 35
	2 levels		1 - 5	200	35 ... 45
	3 levels		1 - 3 - 5	190	45 ... 55
Leaven*	One level		3	200	35 ... 45
Lasagne*	One level		3	200	30 ... 40
Beefsteak (whole)/ Roast	One level		3	25 min. 250/max after 180 ... 190	100 ... 120
Lamb haunch (casserole)	One level		3	25 min. 220 after 180 ... 190	70 ... 90
Roast chicken	One level		2	15 min. 250/max after 190	55 ... 65
Turkey (5.5 kg)	One level		1	25 min. 250/max after 190	150 ... 210
Fish	One level		3	200	20 ... 30

While cooking with 2 trays at the same time, place the deep tray to the upper shelf and shallow tray to the lower shelf.
* It is suggested to perform preheating for all foods.

(**) For preheating, set the required temperature, the thermostat lamp will go out when the required temperature is reached.

Tips for baking cakes

- If pastry is too dry,
» Increase the temperature by 10°C and reduce the cooking time.
- If pastry dropped,

» Use less liquid or lower the temperature by 10°C.

- If pastry is too dark on top,
» Place it on a lower rack, lower temperature, and increase the cooking time.
- If cooked well on the inside but sticky on the outside,

» Use less liquid, lower the temperature, and increase the cooking time.

Tips for baking pastry

1. If the pastry is too dry,
 - » Increase the temperature some 10°C and decrease the cooking time.
 - » Dampen the layers of dough with a sauce composed of milk, oil, egg and yoghurt.
2. If the pastry takes too long to bake,
 - » Pay care that the thickness of the pastry you have prepared does not exceed the depth of the tray and remain level with it.
3. If the upper side of the pastry gets browned, but the lower part is not cooked,
 - » Make sure that the amount of sauce you have used for the pastry is not too much at the bottom of the pastry. Try to scatter the sauce equally between and on the dough layers for an even browning.
 - » Cook the pastry in accordance with the mode and temperature given in the cooking table. If the bottom part is still not browned enough, place it on a lower shelf next time.

Tips for cooking vegetables

1. If the vegetable dish runs out of juice and gets to dry,
 - » Sthin using a lid during cooking will keep the juice of the dish in the pan,

Cooking times table for grilling

Grilling with electric grill

Food	Insertion level	Grilling time (approx.)
Fish	4...5	20...25 min. [#]
Sliced chicken	4...5	25...35 min.
Lamb chops	4...5	20...25 min.
Roast beef	4...5	25...30 min. [#]
Veal chops	4...5	25...30 min. [#]
Toast bread	4	1...2 min.

[#] depending on thickness

cook your vegetable dishes in a pan with a lid instead of a tray.

2. If a vegetable dish does not get cooked,
 - » Boil the vegetables beforehand or prepare them like canned food and put in the oven.

How to operate the grill

-  Before using the oven the clock time must be set. If the clock time is not set, the oven will not work.

-  Hot surfaces may cause burns!
Close oven door during grilling.

Switch on grill

1. Set the function knob onto the grill symbol.
2. Set grill temperature.
3. Preheat for approximately 5 minutes, if it is necessary.
 - » The thermostat lamp is switched on.

Switch off grill



1. Turn grill control knob to off position (top).

Shelf positions

For optimum grill coverage, position the wire shelf towards the front of the oven just out of contact with the glass door. Placing the wire shelf fully to the rear of the oven will reduce the grill coverage.

6 Maintenance and care

General information

-  Risk of electric shock!
Switch off the electricity before cleaning appliance to avoid an electric shock.
-  Hot surfaces may cause burns!
Allow the appliance to cool down before you clean it.
-  The surface may get damaged by some detergents or cleaning materials.
Do not use aggressive detergents, cleaning powder/cream or any sharp objects.

Clean the appliance thoroughly after each use; in this way it will be possible to remove cooking residues more easily, thus avoiding these from burning the next time the appliance is used.

No special cleaning agents are required for cleaning the appliance. It is recommended to use warm water with washing liquid, a soft cloth or sponge and use a dry cloth for drying.

Do not use any abrasive cleaning materials!

-  Do not use steam cleaners for cleaning.

Cleaning the control panel

-  Damage of the control panel!
Do not remove the control knobs for control panel cleaning.

Clean control panel and control knobs.

Cleaning the oven

No oven cleaner or any other special cleaning agent is required for cleaning

the oven. It is recommended to wipe the oven with a damp cloth while it is still warm.

To clean the side wall,

1. Remove the front section of the side rack by pulling it in the opposite direction of the side wall.
2. Remove the side rack completely by pulling it towards you.

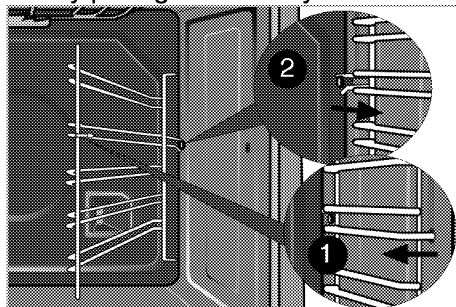

Clean oven door

Don't use any harsh abrasive cleaners or sharp metal scrapers for cleaning the oven door. They could scratch the surface and destroy the glass.

-  Front door inner glass is coated to easy clean material. Do not use any harsh abrasive cleaners, hard metal scrapers, scouring pads or bleach to clean front door inner glass as they may scratch the surface. This may destroy the coating material.

Taking off the door inner glass

The inner glass panel of the oven door can be removed for cleaning.

1. Open oven door.

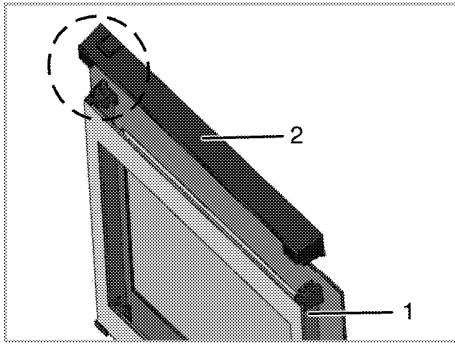

- 1 Frame
2 Plastic part
- Remove the plastic part mounted upper side of the door by lifting upwards.

i When the plastic upper part is removed, please support the glass pane securely so that it will not fall.

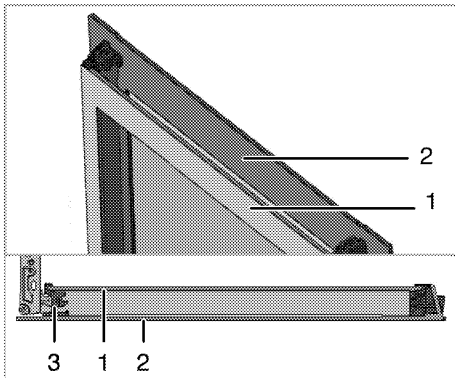

- 1 Inner glass
2 Outer glass
3 Plastic housing for glass-bottom
- As shown in the figure, pull the inner glass slightly in 'A' direction. Then remove the glass by lifting in 'B' direction.

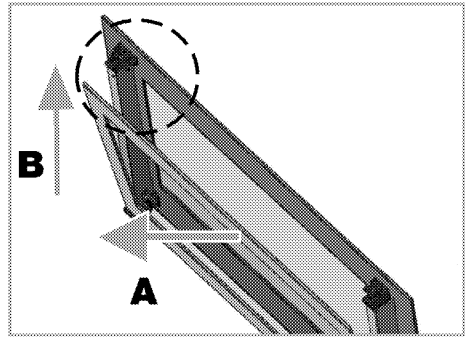

It is important in mounting inner glass to position the bottom corners of glass into bottom plastic housings properly. Push the plastic part against to the frame until you hear the “click” noise.

Replacing the oven lamp

⚠ Hot surfaces may cause burns! Make sure that the appliance is switched off and cooled down in order to avoid the risk of an electrical shock.

The oven lamp is a special heat-resisting (T 300 °C) electric light bulb; see *Technical specifications, page 5*. Oven lamps can be obtained from a good local electrical store.

i Position of lamp may vary from diagram.

1. Switch off the appliance at the mains.
2. Unscrew glass cover by turning anti-clockwise.

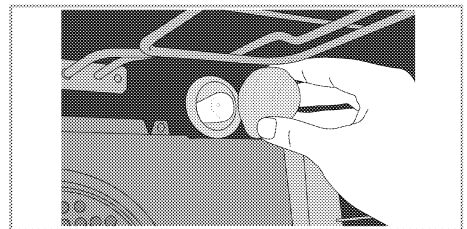

3. Unscrew oven lamp by turning anti-clockwise and replace it with new one.
4. Refit the glass cover.

7 Troubleshooting

 Risk of electric shock, short circuit or fire by unprofessional repairs! Repairs on the appliance must be carried out by an approved service centre.

Normal operating conditions

- Smoke and smell may emit for a couple of hours during the first operation.

Electrical equipment

Malfunction/problem	Possible cause	Advice/remedy
The appliance does not work.	The mains fuse is defective or has tripped.	Check fuses in the fuse box. If necessary, replace or reset them.
	Timer buttons do not work.	Keylock may be enabled. Please disable it(See; <i>How to use the program lock, page 19</i>).
Oven light does not work	Oven lamp is defective.	Replace oven lamp.
	No current.	Check fuses in the fuse box. If necessary, replace or reset them.
Oven does not heat.	Function knob and/thermostat knob are not set.	Set function knob and thermostat knob.
	If the appliance has a timer, the timer may not be set.	Set the time.
	No power.	Check mains supply and fuse box.

Clock/ timer (If the appliance has a digital timer)

Malfunction/problem	Possible cause	Advice/remedy
Clock display is blinking or clock symbol is on.	Power was interrupted previously.	Set time Then switch the oven off with function knobs, set the oven function again.

If the problem has not been solved:

1. Separate unit from the mains supply (deactivate or unscrew fuse).
2. Call the appropriate telephone number for your area as shown in the Guarantee and Service section of this user manual.

- It is normal that steam escapes during operation.
- When the metal parts are heated, they may expand and cause noise.

Before you call the service, please check the following points.



Do not attempt to repair the appliance yourself. There are no customer service items inside the appliance.

3. The mounting for side opening oven doors cannot be reserved.

8 Guarantee and Service

Your Beko product is guaranteed against the cost of breakdown repairs : Freestanding appliances : 1 year
Built-in appliances : 2 year
from the date of the original purchase.

What is covered?

- All repairs necessary as a result of faulty materials, defective components or manufacturing defect.
- The cost of all functional replacement parts.
- The labour costs of a Beko approved repairer to carry out the repair.

What is not covered?

- Transit or delivery damage
- Accidental damage
- Misuse, or abuse.
- Cabinet or appearance parts, including knobs and flaps
- Accessory items, including ice trays, scrapers, cutlery baskets,
- Repairs required as a result of unauthorised repairs or inexperienced installation that fails to meet the requirements contained in the user instruction book.

Repairs to products used on commercial or non-residential household premises.

Important notes.

- The product is guaranteed for domestic household use only.
- The guarantee will be void if the product is installed or used in commercial or non-residential household premises.
- The product must be correctly installed, located and operated in accordance with the instructions contained in the User Instructions Booklet provided.
- Professional Installation by a qualified plumber/electrical appliance installer is recommended for all Washing & Dishwashing Machines and Electric Cookers
- Gas Cookers must only be installed by a Gas Safe (or BORD GAIS) registered Gas Installer.
- The guarantee is given only within the boundaries of the United Kingdom.
- The guarantee is not transferable if the product is resold.
- Beko plc disclaims any liability for incidental or consequential damages.
- The guarantee does not in anyway diminish your statutory or legal rights.

HOW TO OBTAIN SERVICE UNDER THE MANUFACTURERS GUARANTEE

Please keep your purchase receipt or other proof of purchase in a safe place; you will need to have it should the product require attention in the guarantee period

You should also complete the details below; it will help us assist you quicker when requesting service. (The model number is printed on the Instruction Booklet)

Model Number: _____ Purchased From: _____ Date of purchase: _____

For service under guarantee simply telephone the appropriate number below

LOCATION

TELEPHONE

UK Mainland & Northern Ireland

Fridges & Freezers	0845 600 4903
Electric Cookers	0845 600 4902
Gas & Dual Fuel Cookers	0845 600 4905
Washing Machines & Dishwashers	0845 600 4906

Republic of Ireland

All Refrigeration, Cooking, Washing & Dishwashing Machines	01 862 3411
--	-------------

Before requesting service please check the trouble-shooting guide in the Operating Instructions as a charge may be levied where no fault is found even though your product may still be under guarantee.

Service once the manufacturers guarantee has expired.

If you have purchased an extended guarantee please refer to the instructions contained within the extended guarantee agreement document. Otherwise please call the above numbers where service can be obtained at a charge.

Should you experience any difficulty in obtaining service please call the

Beko Customer Help-Line on 0845 600 4911

Beko House, Caxton Way, Watford, Herts, WD18 8UF, Tel: 0845 600 4911

