

Blomberg

Built-in Oven

User Manual



ROEN9222DX

385443375/ EN/ R.AA/ 05/05/2023 00:42
7758286358



Welcome!

Dear Customer,

Thank you for choosing the Blomberg product. We want your product, manufactured with high quality and technology, to offer you the best efficiency. Therefore, carefully read this manual and any other documentation provided before using the product.

Keep in mind all the information and warnings stated in the user's manual. This way, you will protect yourself and your product against the dangers that may occur.

Keep the user's manual. If you give the product to someone else, give the manual with it. The warranty conditions, usage and troubleshooting methods for your product are provided in this manual.

The symbols and their descriptions in the user's manual:



Hazard that may result in death or injury.



Important information or useful usage tips.



Read the user's manual.



Hot surface warning.

NOTICE Hazard that may result in material damage to the product or its environment.

Arçelik A.Ş.

Karaağaç caddesi No:2-6
34445 Sütlüce/İstanbul/TURKEY

Made in TURKEY

Table of Contents

1 Safety Instructions.....	4
1.1 Intended Use.....	4
1.2 Child, Vulnerable Person and Pet Safety	4
1.3 Electrical Safety.....	5
1.4 Transportation Safety	6
1.5 Installation Safety.....	7
1.6 Safety of Use	7
1.7 Temperature Warnings	8
1.8 Accessory Use.....	8
1.9 Cooking Safety	8
1.10 Maintenance and Cleaning Safety	9
2 Environmental Instructions.....	10
2.1 Waste Directive.....	10
2.1.1 Compliance with the WEEE Directive and Disposing of the Waste Product	10
2.2 Package Information.....	10
2.3 Recommendations for Energy Saving.....	10
3 Your product	11
3.1 Product Introduction	11
3.2 Product Control Panel Introduction and Usage.....	11
3.2.1 Control Panel.....	12
3.2.2 Introduction of the oven control panel	12
3.3 Oven operating functions.....	12
3.4 Product Accessories	13
3.5 Use of Product Accessories	14
3.6 Technical Specifications.....	17
4 First Use.....	18
4.1 First Timer Setting.....	18
4.2 Initial Cleaning	18
5 Using the Oven.....	19
5.1 General Information on Using the Oven	19
5.2 Operation of the Oven Control Unit	19
5.3 Settings	21
6 General Information About Baking.....	23
6.1 General Warnings About Baking in the Oven	23

6.1.1 Pastries and oven food.....	23
6.1.2 Meat, Fish and Poultry	26
6.1.3 Grill	27
6.1.4 Test foods.....	28
7 Maintenance and Cleaning.....	29
7.1 General Cleaning Information	29
7.2 Cleaning Accessories	30
7.3 Cleaning the Control Panel.....	30
7.4 Cleaning the inside of the oven (cooking area)	31
7.5 Easy Steam Cleaning.....	31
7.6 Cleaning the Oven Door.....	32
7.7 Removing the Inner Glass of The Oven Door.....	33
7.8 Cleaning the Oven Lamp	33
8 Troubleshooting	34



1 Safety Instructions

- This section includes the safety instructions necessary to prevent the risk of personal injury or material damage.
- If the product is handed over to someone else for personal use or second-hand use purposes, the user's manual, product labels and other relevant documents and parts should also be given.
- Our company shall not be held responsible for damages that may occur if these instructions are not observed.
- Failure to follow these instructions shall void any warranty.
- Always have the installation and repair works made by the manufacturer, the authorised service or a person that the importer company shall designate.
- Use original spare parts and accessories only.
- Do not repair or replace any component of the product unless it is clearly specified in the user's manual.
- Do not make technical modifications on the product.



1.1 Intended Use

- This product is designed to be used at home. It is not suitable for commercial use.
- Do not use the product in gardens, balconies or other outdoors. This product is intended to be used in households and in the staff kitchens of shops, offices and other working environments.
- **WARNING:** This product should be used for cooking purposes only. It should not be used for different purposes, such as heating the room.
- The oven can be used to defrost, bake, fry and grill food.
- This product should not be used for heating, plate heating, drying by hanging towels or clothes on the handle.



1.2 Child, Vulnerable Person and Pet Safety

- This product can be used by children 8 years of age and older, and people who are underdeveloped in physical, sensory or mental skills, or who have lack of experience and knowledge, as long as they are

- supervised or trained about the safe use and hazards of the product.
- Children should not play with the product. Cleaning and user maintenance should not be performed by children unless there is someone overseeing them.
- This product should not be used by people with limited physical, sensory or mental capacity (including children), unless they are kept under supervision or receive the necessary instructions.
- Children should be supervised to ensure that they do not play with the product.
- Electrical products are dangerous for children and pets. Children and pets must not play with, climb on, or enter the product.
- Do not put objects that children may reach on the product.
- **WARNING:** During use, the accessible surfaces of the product are hot. Keep children away from the product.
- Keep the packaging materials out of the reach of children. There is a hazard of injury and suffocation.
- When the door is open, do not put any heavy objects on it or allow children to sit on it. You may cause the oven to tip over or damage the door hinges.
- For the safety of children, cut the power plug and make the product inoperable before disposing the product.



1.3 Electrical Safety

- Plug the product into a grounded outlet protected by a fuse that matches the current ratings indicated on the type label. Have the grounding installation made by a qualified electrician. Do not use the product without grounding in accordance with local / national regulations.
- The plug or the electrical connection of the product should be in an easily accessible place (where it will not be affected by the flame of the hob). If this is not possible, there should be a mechanism (fuse, switch, key switch, etc.) on the electrical installation to which the product is connected, in compliance with the electrical regulations and separating all poles from the network.

- The product must not be plugged into the outlet during installation, repair, and transportation.
 - Plug the product into an outlet that meets the voltage and frequency values specified on the type label.
 - If your product does not have a power cable, only use the power cable described in the "Technical specifications" section.
 - Do not jam the power cable under and behind the product. Do not put a heavy object on the power cable. The power cable should not be bent, crushed, and come into contact with any heat source.
 - The rear surface of the oven gets hot when it is in use. Power cords must not touch the back surface, connections may be damaged.
 - Do not jam the electric cables into the oven door and do not pass them over hot surfaces. Otherwise, cable insulation may melt and cause fire as a result of short circuit.
 - Use original cable only. Do not use cut or damaged cables or intermediate cables.
 - If the power cable is damaged, it must be replaced by the manufacturer, an authorized service or a person to be specified by the importer company in order to prevent possible dangers.
 - **WARNING:** Before replacing the oven lamp, be sure to disconnect the product from the mains supply to avoid the risk of electric shock. Unplug the product or turn off the fuse from the fuse box.
- If your product has a power cable and plug:
- Do not plug the product into an outlet that is loose, has come out of its socket, is broken, dirty, oily, with risk of water contact (for example, water that may leak from the counter).
 - Never touch the plug with wet hands! Never unplug by pulling on the cable, always pull out by holding the plug.
 - Make sure that the product plug is securely plugged into the outlet to avoid arcing.



1.4 Transportation Safety

- Disconnect the product from the mains before transporting the product.

- The product is heavy, carry the product with at least two people.
- Do not use the door and / or handle to transport or move the product.
- Do not put other items on the product and carry the product upright.
- When you need to transport the product, wrap it with bubble wrap packaging material or thick cardboard and tape it tightly. Secure the product tightly with tape to prevent the removable or moving parts of the product and the product from getting damaged.
- Check the overall appearance of the product for any damage that may have occurred during transportation.

1.5 Installation Safety

- Before the product is installed, check the product for any damage. If the product is damaged, do not install it.
- Do not install the product near heat sources (radiators, stoves, etc.).
- Keep the surroundings of all ventilation ducts of the product open.
- To prevent overheating, the product should not be installed behind decorative doors.

1.6 Safety of Use

- Ensure that the product is switched off after every use.
- If you will not use the product for a long time, unplug it or turn off the fuse from the fuse box.
- Do not operate defective or damaged product. If any, disconnect the electricity / gas connections of the product and call the authorized service.
- Do not use the product if the front door glass is removed or cracked.
- Do not climb on the product to reach anything or for any other reason.
- Never use the product when your judgement or coordination is impaired by the use of alcohol and/or drugs.
- Flammable objects kept in the cooking area may catch fire. Never store flammable objects in the cooking area.
- The oven handle is not a towel dryer. When using the product, do not hang towels, gloves or similar textiles on the handle.
- The hinges of the product door move when opening and closing the door and might jam. When opening / closing the door, do not hold the part with the hinges.

1.7 Temperature Warnings

- **WARNING:** The accessible parts of the product will be hot during use. Care should be taken to avoid touching the product and heating elements. Children under the age of 8 should not be brought close to the product without an adult.
- Do not place flammable / explosive materials near the product, as the edges will be hot while it is operating.
- As steam may be exhaled, keep away while opening the oven door. The steam may burn your hand, face and / or eyes.
- During operation, the product may become hot. Care should be taken to avoid touching hot parts, inside of the oven and heating elements.
- Always use heat resistant oven gloves while placing food in the hot oven, or removing the food from the hot oven, etc.

1.8 Accessory Use

- It is important that the wire grill and tray are placed properly on the wire shelves. For

detailed information, refer to the section "**Usage of accessories**".

- Accessories can damage the door glass when closing the product door. Always push the accessories to the end of the cooking area.

1.9 Cooking Safety

- Be careful when using alcoholic drinks in your dishes. Alcohol evaporates at high temperatures and may cause fire since it can ignite when it comes into contact with hot surfaces.
- Food waste, oil, etc. in the cooking area may catch fire. Before cooking, remove such coarse dirt.
- Food Poisoning Hazard: Do not let food sit in oven for more than 1 hour before or after cooking. Otherwise it may cause food poisoning or diseases.
- Do not heat closed tins and glass jars in the oven. The pressure that would build-up in the tin/jar may cause it to burst.
- Place the greaseproof paper in a cookware or on the oven accessory (tray, wire grill, etc.) with food and place it in the

preheated oven. Remove any excessive pieces of greaseproof paper hanging from the accessory or container to avoid the risk of touching the oven heater elements. Never use greaseproof paper at an oven temperature higher than the maximum use temperature specified on the greaseproof paper you are using. Never place greaseproof paper on the oven base.

- Do not place baking trays, dishes or aluminium foil directly onto the bottom of the oven. The accumulated heat might damage the bottom of the oven.
- Close the oven door during grilling. Hot surfaces may cause burns!
- Food not suitable for grilling carries a fire hazard. Grill only food that is suitable for heavy grill fire. Also, do not place the

food too far in the back of the grill. This is the hottest area and fatty foods may catch fire.



1.10 Maintenance and Cleaning Safety

- Wait for the product to cool before cleaning the product. Hot surfaces may cause burns!
- Never wash the product by spraying or pouring water on it! There is the risk of electric shock!
- Do not use steam cleaners to clean the product as this may cause an electric shock.
- Do not use harsh abrasive cleaners, metal scrapers, wire wool or bleach materials to clean the oven front door glass / (if present) oven upper door glass. These materials can cause glass surfaces to be scratched and broken.
- Always keep the control panel clean and dry. A damp and dirty surface may cause problems in operating the functions.

2 Environmental Instructions

2.1 Waste Directive

2.1.1 Compliance with the WEEE Directive and Disposing of the Waste Product

This product complies with EU WEEE Directive (2012/19/EU). This product bears a classification symbol for waste electrical and electronic equipment (WEEE).



This product has been manufactured with high quality parts and materials which can be reused and are suitable for recycling. Therefore, do not dispose of the waste product with normal domestic and other wastes at the end of its service life. Take it to a collection point for the recycling of electrical and electronic equipment. You can ask your local administration about these collection points. Disposing of the appliance properly helps prevent negative consequences for the environment and human health.

Compliance with RoHS Directive:

The product you have purchased complies with EU RoHS Directive (2011/65/EU). It does not contain harmful and prohibited materials specified in the Directive.

2.2 Package Information

Packaging materials of the product are manufactured from recyclable materials in accordance with our National Environment Regulations. Do not dispose of the pack-

aging waste with the household or other wastes, take it to the packaging material collection points designated by the local authorities.

2.3 Recommendations for Energy Saving

According to EU 66/2014, information on energy efficiency can be found on the product receipt supplied with the product.

The following suggestions will help you use your product in an ecological and energy-efficient way:

- Defrost frozen food before baking.
- In the oven, use dark or enamelled containers that transmit heat better.
- If specified in the recipe or user's manual, always preheat. Do not open the oven door frequently during baking.
- Turn off the product 5 to 10 minutes before the end time of baking in prolonged bakings. You can save up to 20% electricity by using residual heat.
- Try to cook more than one dish at a time in the oven. You may cook at the same time by placing two cookers on the wire rack. In addition, if you cook your meals one after the other, it will save energy because the oven will not lose its heat.
- Do not open the oven door when baking in the "Eco fan heating" operating function. If the door is not opened, the internal temperature is optimized to save energy in the "Eco fan heating" operating function, and this temperature may differ from what is shown on the display.

3 Your product

3.1 Product Introduction

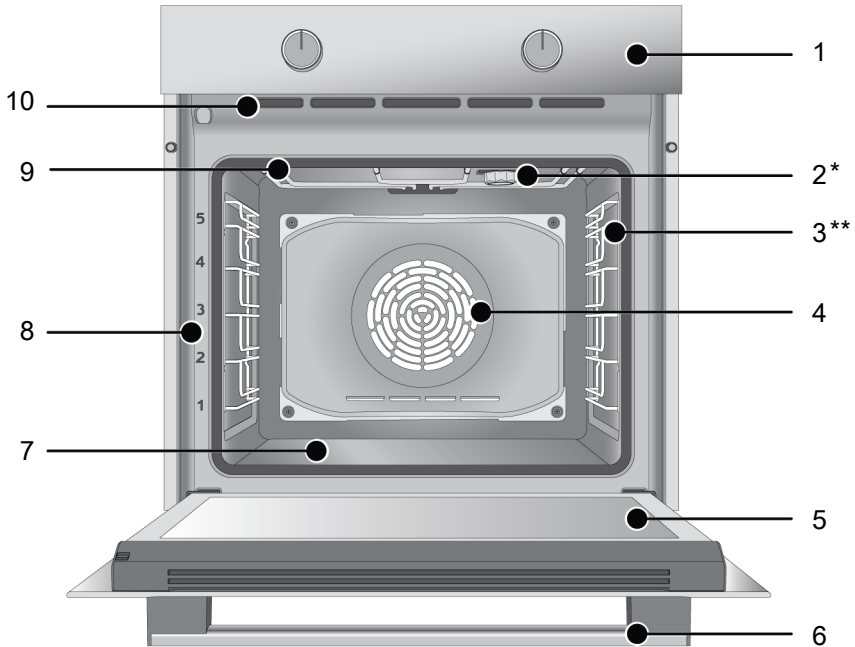

1 Control panel

3 Wire shelves

5 Door

7 Lower heater (under the steel plate)

9 Upper heater

2 Lamp

4 Fan motor (behind the steel plate)

6 Handle

8 Shelf positions

10 Ventilation holes

* Varies depending on the model. Your product may not be equipped with a lamp, or the type and location of the lamp may differ from the illustration.

** Varies depending on the model. Your product may not be equipped with a wire rack. In the image, a product with wire rack is shown as an example.

3.2 Product Control Panel Introduction and Usage

In this section, you can find the overview and basic uses of the product's control panel. There may be differences in images and some features depending on the type of product.

3.2.1 Control Panel

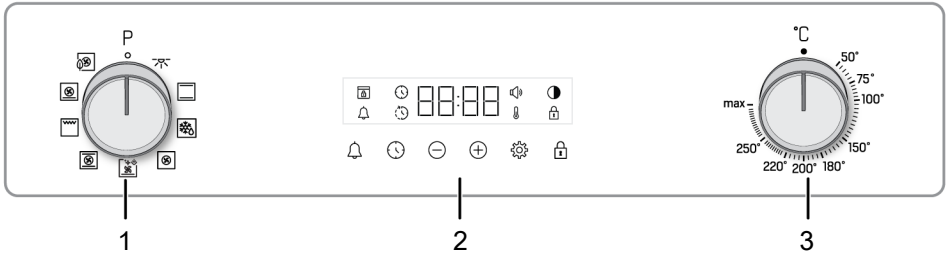

1 Function selection knob

2 Timer

3 Temperature selection knob

If there are knob(s) controlling your product, in some models this/these knob(s) may be so that they come out when pushed (buried knobs). For settings to be made with these knobs, first push the relevant knob in and pull out the knob. After making your adjustment, push it in again and replace the knob.

3.2.2 Introduction of the oven control panel

Function selection knob

You can select the oven operating functions with the function selection knob. Turn left / right from closed (top) position to select.

Temperature knob

You can select the temperature you want to cook with the temperature knob. Turn clockwise from the closed (top) position to select.

Oven inner temperature indicator

You can understand the oven interior temperature from the temperature symbol on the timer display. The temperature symbol appears on the display when the cooking starts, and the temperature symbol disappears when the appliance reaches the set temperature. When the temperature inside the oven drops below the set temperature, the temperature symbol reappears.

Timer

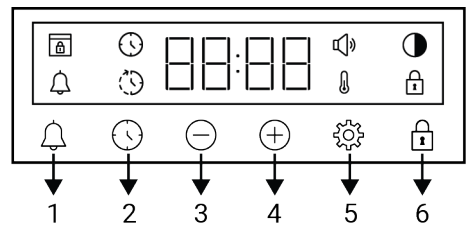

- 1 Alarm key
- 2 Time setting key
- 3 Decrease key
- 4 Increase key
- 5 Settings key
- 6 Key lock key

Display symbols

- : Baking time symbol
- : Baking end time symbol *
- : Alarm symbol
- : Brightness symbol
- : Key lock symbol
- : Temperature symbol
- : Volume level symbol
- : Door lock symbol *









*It varies depending on the product model. It may not be available on your product.

3.3 Oven operating functions

On the function table, the operating functions you can use in your oven and the highest and lowest temperatures that can

be set for these functions are shown. The

order of the operating modes shown here may differ from the arrangement on your product.

Function symbol	Function description	Temperature range (°C)	Description and use
	Oven lamp	-	No heater works in the oven. Only the oven lamp lights up.
	Operating with fan	-	The oven is not heated. Only the fan (on the back wall) operates. Frozen food with granules is slowly defrosted at room temperature, cooked food is cooled. The time required to defrost a whole piece of meat is longer than for foods with grains.
	Top and bottom heating	*	Food is heated from above and below at the same time. Suitable for cakes, pastries or cakes and stews in baking moulds. Cooking is done with a single tray.
	Fan assisted bottom heating	*	The hot air heated by the lower heater is distributed equally and rapidly throughout the oven with the fan. Cooking is done with a single tray. This function should also be used for easy steam cleaning.
	Fan Heating	*	The hot air heated by the fan heater is distributed equally and rapidly throughout the oven with the fan. It is suitable for multi-tray cooking at different shelf levels.
	Eco fan heating	*	In order to save energy, you can use this function instead of using "Fan Heating" in the range of 160-220°C. But; cooking time will be slightly longer.
	Pizza function	*	The lower heater and fan heating work. It is suitable for cooking pizza.
	"3D" function	*	Upper heating, lower heating and fan heating functions operate. Each side of the product to be cooked is cooked equally and quickly. Cooking is done with a single tray.
	Full grill	*	The large grill on the oven ceiling works. It is suitable for grilling in large amounts.

* Your product operates in the temperature range specified on the temperature knob.

3.4 Product Accessories

There are various accessories in your product. In this section, the description of the accessories and the descriptions of the correct usage are available. Depending on the product model, the supplied accessory varies. All accessories described in the user's manual may not be available in your product.

 The trays inside your appliance may be deformed with the effect of the heat. This has no effect on the functionality. Deformation disappears when the tray is cooled.

Standard tray

It is used for pastries, frozen foods and frying large pieces.

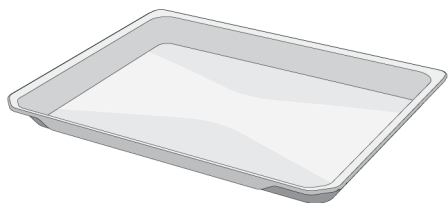

Wire grill

It is used for frying or placing the food to be baked, fried and stewed on the desired shelf.

On models with wire shelves :

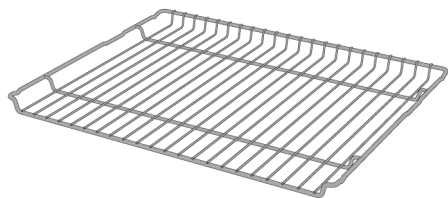

On models without wire shelves :

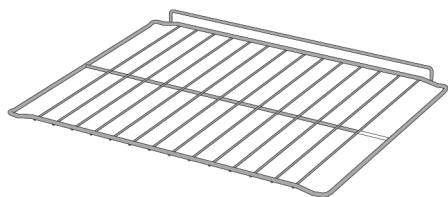

Wire grill in tray

By placing it in the tray (if provided), it is ensured that the oils flowing while grilling are collected in the tray and thus the contamination of the oven is prevented.

Wire grill in tray is not suitable for use in deep tray.

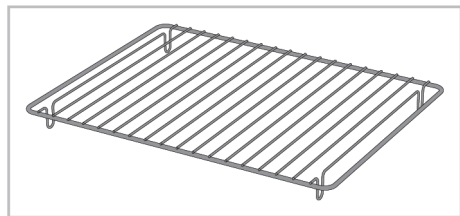

3.5 Use of Product Accessories

Cooking shelves

There are 5 levels of shelf position in the cooking area. You can also see the order of the shelves in the numbers on the front frame of the oven.

On models with wire shelves :

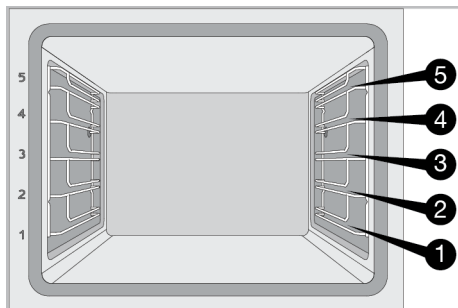

On models without wire shelves :

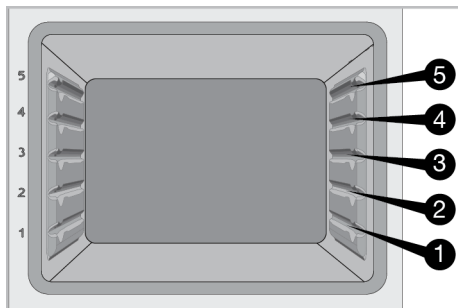

Placing the wire grill on the cooking shelves

On models with wire shelves :

It is crucial to place the wire grill on the wire side shelves properly. While placing the wire grill on the desired shelf, the open section must be on the front. For better cooking, the wire grill must be secured on the wire shelf's stopping point. It must not pass over the stopping point to contact with the rear wall of the oven.

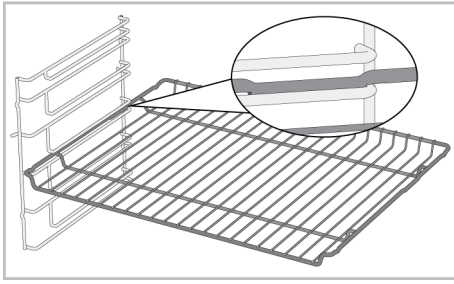

On models without wire shelves :

It is crucial to place the wire grill on the side shelves properly. The wire grill has one direction when placing it on the shelf. While placing the wire grill on the desired shelf, the open section must be on the front.

On models without wire shelves :

It is also crucial to place the trays on the side shelves properly. The tray has one direction when placing it on the shelf. While placing the tray on the desired shelf, its side designed for holding must be on the front.

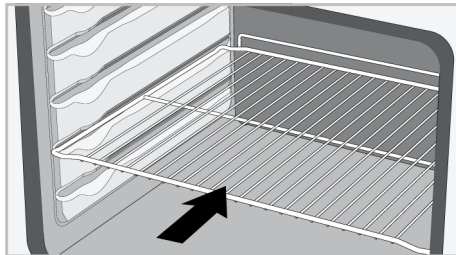
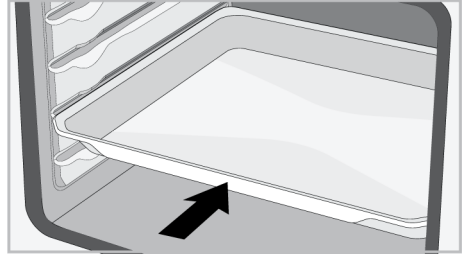

Stopping function of the wire grill

There is a stopping function to prevent the wire grill from tipping out of the wire shelf. With this function, you can easily and safely take out your food. While removing the wire grill, you can pull it forward until it reaches the stopping point. You must pass over this point to remove it completely.

Placing the tray on the cooking shelves

On models with wire shelves :

It is also crucial to place the trays on the wire side shelves properly. While placing the tray on the desired shelf, its side designed for holding must be on the front. For better cooking, the tray must be secured on the stopping socket on the wire shelf. It must not pass over the stopping socket to contact with the rear wall of the oven.

On models with wire shelves :

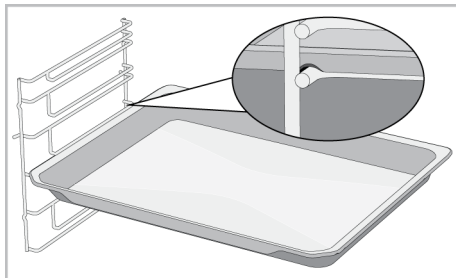
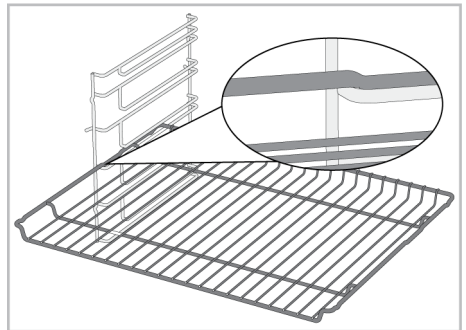

On models without wire shelves :

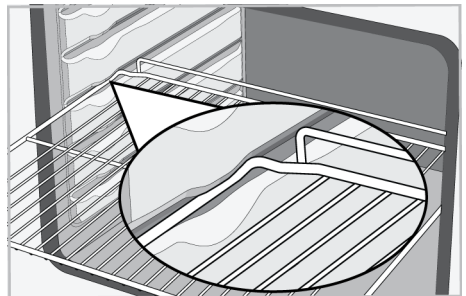

Tray stopping function - On models with wire shelves

There is also a stopping function to prevent the tray from tipping out of the wire shelf. While removing the tray, release it from the rear stopping socket and pull it towards yourself until it reaches the front side. You must pass over this stopping socket to remove it completely.

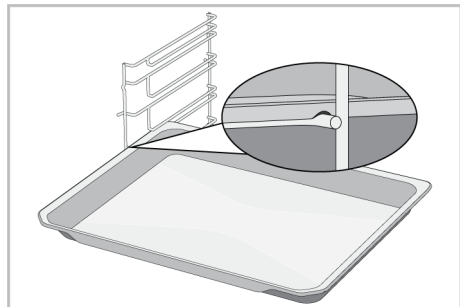
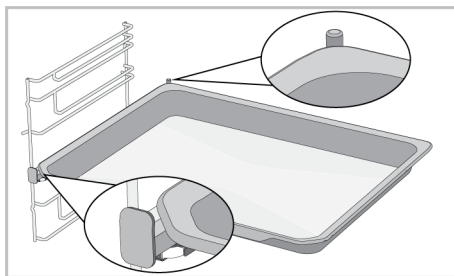

Proper placement of the wire grill and tray on the telescopic rails-On models with wire shelves and telescopic models

Thanks to telescopic rails, trays or the wire grill can be easily installed and removed. When using trays and wire grills with the telescopic rail, care should be taken that the pins on the front and back of the telescopic rails, rest against the edges of the grill and the tray (shown in the figure).

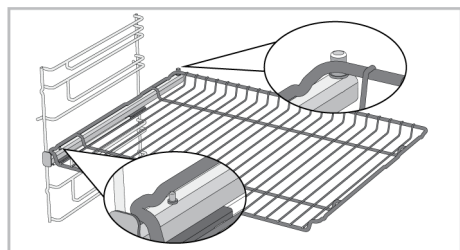

3.6 Technical Specifications

General specifications	
Product external dimensions (height/width/depth) (mm)	595 /594 /567
Oven installation dimensions (height / width / depth) (mm)	590 - 600 /560 /min. 550
Voltage/Frequency	220-240 V ~; 50 Hz
Cable type and section used/suitable for use in the product	min. H05VV-FG 3 x 1,5 mm ²
Total power consumption (kW)	3,3
Fuse (min.)	16 A
Oven type	Multifunction oven

Basics: Information on the energy label of home type electrical ovens is given in accordance with the EN 60350-1 / IEC 60350-1 standard. The values are determined in Top and bottom heating or (if present) Fan assisted bottom/top heating functions with the standard load.

Energy efficiency class is determined in accordance with the following prioritization depending on whether the relevant functions exist on the product or not. 1-Eco fan heating , 2-Fan Heating , 3-Fan assisted low grill , 4-Top and bottom heating.



Technical specifications may be changed without prior notice to improve the quality of the product.



Figures in this manual are schematic and may not exactly match your product.







Values stated on the product labels or in the documentation accompanying it are obtained in laboratory conditions in accordance with relevant standards. Depending on operational and environmental conditions of the product, these values may vary.

4 First Use

Before you start using your product, it is recommended to do the following stated in the following sections respectively.

4.1 First Timer Setting

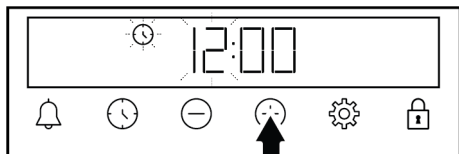

 Always set the time of day before using your oven. If you do not set it, you cannot cook in some oven models.

1. When the oven is first started, "12:00" and  symbol will flash on the display.
2. Set the time of day by touching the / keys.

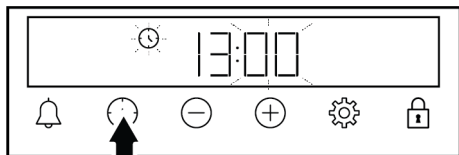

3. Touch  or  key to activate the minutes field.





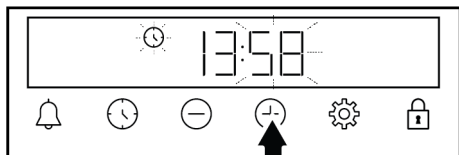

4. Touch the / keys to set the minute.



5. Confirm by touching the  or  key.

⇒ The time of day is set and the  symbol disappears on the display.

 If the first timer is not set, "12:00" and  symbol continue to flash and your oven will not start. For your oven to function, you must confirm the time of day by setting the time of day or touching the  key when it is at "12:00". You can change the time of day setting later as described in the "Settings" section.

 In the event of a power outage, the time of day settings are cancelled. It should be set again.

4.2 Initial Cleaning

1. Remove all packaging materials.
2. Remove all accessories from the oven provided with the product.
3. Operate the product for 30 minutes and then, turn it off. This way, residues and layers that may have remained in the oven during production are burned and cleaned.
4. When operating the product, select the highest temperature and the operating function that all the heaters in your product operate. See "Oven operating functions [► 12]". You can learn how to operate the oven in the following section.
5. Wait for the oven to cool.
6. Wipe the surfaces of the product with a wet cloth or sponge and dry with a cloth.

Before using the accessories:

Clean the accessories you remove from the oven with detergent water and a soft cleaning sponge.

NOTICE: Some detergents or cleaning agents may cause damage to the surface. Do not use abrasive detergents, cleaning powders, cleaning creams or sharp objects during cleaning.

NOTICE: During the first use, smoke and odour may come up for several hours. This is normal and you just need good ventilation to remove it. Avoid directly inhaling the smoke and odours that form.

5 Using the Oven

5.1 General Information on Using the Oven

Cooling fan (It varies depending on the product model. It may not be available on your product.)

Your product has a cooling fan. The cooling fan is activated automatically when necessary and cools both the front of the product and the furniture. It is automatically deactivated when the cooling process is finished. Hot air comes out over the oven door. Do not cover these ventilation openings with anything. Otherwise, the oven may overheat. The cooling fan continues to operate during oven operation or after the oven is turned off (approximately 20-30 minutes). If you cook by programming the oven timer, at the end of the baking time, the cooling fan turns off with all functions. The cooling fan running time cannot be determined by the user. It turns on and off automatically. This is not an error.

Oven lighting

The oven lighting is turned on when the oven starts baking. In some models, the lighting is on during baking, while in some models it turns off after a certain time.

If you wish the oven lamp to be on incessantly, select the "Oven lamp" operating status with the function selection knob.

5.2 Operation of the Oven Control Unit

General warnings for the oven control unit

- The maximum time that can be set for the baking process is 5 hours 59 minutes. In case of a power failure, the program is canceled. You will need to re-program.

- While making any adjustments, the relevant symbols flash on the display. A short time should be waited for the settings to be saved.
- If any cooking setting has been made, the time of day cannot be adjusted.
- If cooking time is set when cooking starts, the remaining time is displayed on the display.
- In cases where cooking time or cooking end time is set; you can cancel automatically by touching the ⌚ key for a long time.

Timer

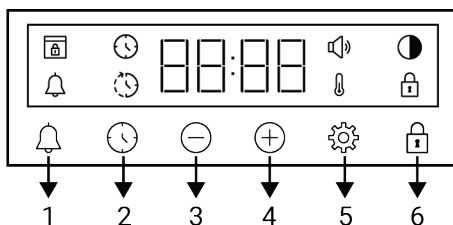

- 1 Alarm key
- 2 Time setting key
- 3 Decrease key
- 4 Increase key
- 5 Settings key
- 6 Key lock key

Display symbols

- ⌚ : Baking time symbol
- 🕒 : Baking end time symbol *
- 🔔 : Alarm symbol
- 🌑 : Brightness symbol
- 🔒 : Key lock symbol
- 🌡️ : Temperature symbol
- 🔊 : Volume level symbol
- 🚪 : Door lock symbol *

*It varies depending on the product model. It may not be available on your product.

Turning on the oven

When you select a operating function you want to cook with the function selection knob and set a certain temperature with the temperature knob, the oven starts operating.



Turning off the oven

You can turn the oven off by turning the function selection knob and temperature knob to the off (up) position.

Manual cooking to select temperature and oven operating function

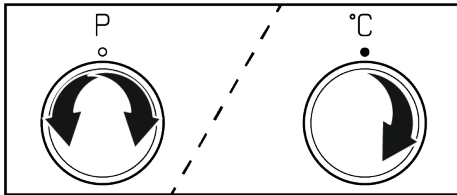

You can cook by making a manual control (at your own control) without setting the cooking time by selecting the temperature and operating function specific to your food.







1. Select the operating function you want to cook with the function selection knob.
2. Set the temperature you want to cook with the temperature knob.
 - ⇒ Your oven will start operating immediately at the selected function and temperature, and the  symbol will appear on the display. When the temperature inside the oven reaches the set temperature, the  symbol disappears. The oven does not switch off automatically since manual cooking is done without setting the cooking time. You have to control cooking and turn it off yourself. When your cooking is completed, turn off the oven by turning the function selection knob and the temperature knob to the off (up) position.

Cooking by setting the cooking time:

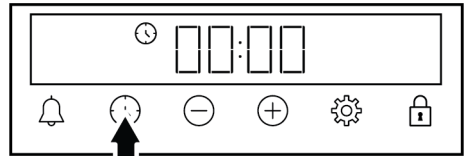
You can have the oven turn off automatically at the end of the time by selecting the temperature and operating function specific to your food and setting the cooking time on the timer.

1. Select the operating function for cooking.
2. Touch the  key until the  symbol appears on the display for the cooking time.



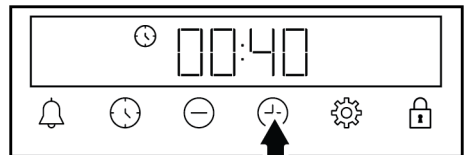

 After setting the operation function and temperature, you can set the cooking time for 30 minutes by touching the  key directly for quick setting of the cooking time and change the time with the  keys.

3. Set the cooking time with the  keys.



 The cooking time increases by 1 minute in the first 15 minutes, after 15 minutes it increases by 5 minutes.

4. Put your food in the oven and set the temperature with the temperature knob.
 - ⇒ Your oven will start operating immediately at the selected function and temperature. The set cooking time starts to count down and the  symbol appears on the display.

When the temperature inside the oven reaches the set temperature, the  symbol disappears.

5. After the set cooking time is completed, on the display, "End" appears, the  symbol flashes and the timer beeps.
6. The warning sounds for two minutes. Press any key to stop the warning. The warning stops and the time of day appears on the display.

 If any key is pushed at the end of the audible warning, the oven will start operating again. To prevent the oven from operating again at the end of the warning, turn off the oven by turning the temperature knob and function knob to the "0" (off) position.



5.3 Settings

Activating the key lock

By using the key lock feature, you can safeguard the timer from interference.

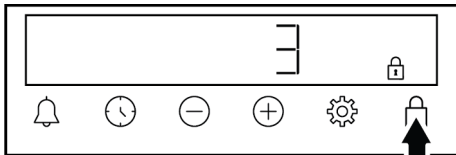
1. Touch the key until the  symbol appears on the display.





⇒ The  symbol is shown on the display and the 3-2-1 count down starts. The key lock activates when the countdown ends. When any key is touched after the key lock is set, the timer sounds an audible signal and the  symbol flashes.

 If you release the key before the end of the countdown, the key lock does not activate.

 Timer keys cannot be used when the key lock is on. The key lock will not be cancelled in case of power failure.



Deactivating the key lock

1. Touch the key until the  symbol disappears from the display.
⇒ The  symbol disappears from the display and the key lock is disabled.

Setting the alarm

You can also use the timer of the product for any warning or reminder other than baking. The alarm clock has no effect on the oven operating functions. It is used for warning purposes. For example, you can use the alarm clock when you want to turn the food in the oven at a certain time. As soon as the time you set has expired, the timer gives you an audible warning.

 The maximum alarm time may be 23 hours 59 minutes.

1. Touch the  until the key  symbol appears on the display.

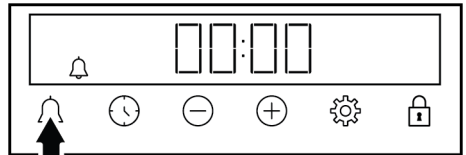

2. Set the alarm time with the \oplus/\ominus keys.

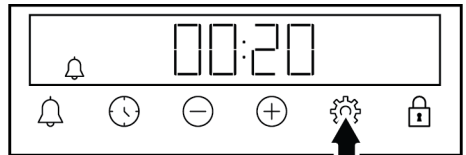

⇒ After setting the alarm time, the  symbol remains lit and the alarm time starts to countdown on the display. If the alarm time and baking time are set at the same time, the shorter time is shown on the display.





3. After the alarm time is completed, the  symbol starts flashing and gives you an audible warning.

Turning off the alarm



1. At the end of the alarm period, the warning sounds for two minutes. Touch any key to stop the audible warning.

⇒ The warning stops and the time of day appears on the display.



If you want to cancel the alarm;

1. Touch the  key until the  symbol appears on the display to reset the alarm time. Touch the  key until the “00:00” symbol appears on the display.
2. You can also cancel the alarm by touching the  key for a long time.

Adjusting the volume

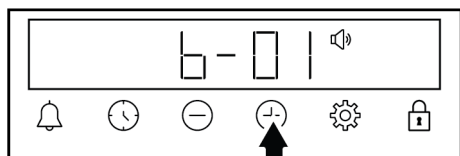
1. Touch  key until the  symbol appears on the display.



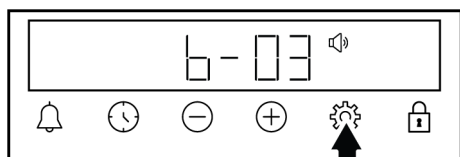

2. Set the desired level with the / keys. (b-01-b-02-b-03)



3. Touch the  key for confirmation or wait without touching any key. The volume set becomes active after a while.

Setting the display brightness

1. Touch  key until the  symbol appears on the display.

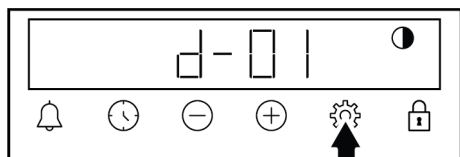



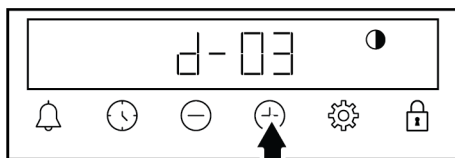

2. Set the desired brightness with the / keys. (d-01-d-02-d-03)





3. Touch the  key for confirmation or wait without touching any key. The brightness set becomes active after a while.

Changing the time of day

On your oven to change the time of day that you have previously set:

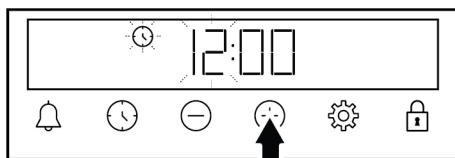
1. Touch the  key until the  symbol appears on the display.
2. Set the time of day by touching the / keys.



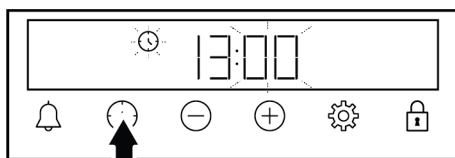

3. Touch  or  key to activate the minutes field.

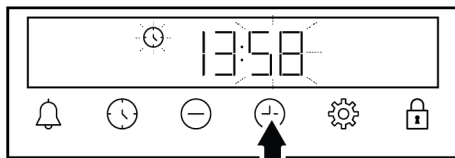

4. Touch the / keys to set the minute.



5. Confirm by touching the  or  key.
⇒ The time of day is set and the  symbol disappears on the display.

6 General Information About Baking

You can find tips on preparing and cooking your food in this section.

Plus, this section describes some of the foods tested as producers and the most appropriate settings for these foods. Appropriate oven settings and accessories for these foods are also indicated.

6.1 General Warnings About Baking in the Oven

- While opening the oven door during or after baking, hot-burning steam may emerge. The steam may burn your hand, face and/or eyes. When opening the oven door, stay away.
- Intense steam generated during baking may form condensed water drops on the interior and exterior of the oven and on the upper parts of the furniture due to the temperature difference. This is a normal and physical occurrence.
- The cooking temperature and time values given for foods may vary depending on the recipe and amount. For this reason, these values are given as ranges.
- Always remove unused accessories from the oven before you start cooking. Accessories that will remain in the oven may prevent your food from being cooked at the correct values.
- For foods that you will cook according to your own recipe, you can reference similar foods given in the cooking tables.
- Using the supplied accessories ensures you get the best cooking performance. Always observe the warnings and information provided by the manufacturer for the external cookware you will use.
- Cut the greaseproof paper you will use in your cooking in suitable sizes to the container you will cook. Greaseproof papers that are overflowing from the container can create a risk of burns and affect the quality of your baking. Use the greaseproof paper you will use in the temperature range specified.

- For good baking performance, place your food on the recommended correct shelf. Do not change the shelf position during baking.

6.1.1 Pastries and oven food

General Information

- We recommend using the accessories of the product for a good cooking performance. If you will use an external cookware, prefer dark, non-sticking and heat resistant ware.
- If preheating is recommended in the cooking table, be sure to put your food in the oven after preheating.
- If you will cook by using cookware on the wire grill, place it in the middle of the wire grill, not near the back wall.
- All materials used in making pastry should be fresh and at room temperature.
- The cooking status of the foods may vary depending on the amount of food and the size of the cookware.
- Metal, ceramic and glass moulds extend the cooking time and the bottom surfaces of pastry foods do not brown evenly.
- If you are using baking paper, a small browning can be observed on the bottom surface of the food. In this situation, you may have to extend your cooking period by approximately 10 minutes.
- The values specified in the cooking tables are determined as a result of the tests carried out in our laboratories. Values suitable for you may differ from these values.
- Place your food on the appropriate shelf recommended in the cooking table. Refer to the bottom shelf of the oven as shelf 1.

Tips for baking cakes

- If the cake is too dry, increase the temperature by 10°C and shorten the baking time.

- If the cake is moist, use a small amount of liquid or reduce the temperature by 10°C.
- If the top of the cake is burnt, put it on the lower shelf, lower the temperature and increase the baking time.
- If the inside of the cake is cooked well, but outside is sticky, use less liquid, decrease the temperature and increase the cooking time.
- If the pastry is getting cooked slowly, make sure that the thickness of the pastry you have prepared does not overflow the tray.
- If the pastry is browned on the surface but the bottom is not cooked, make sure that the amount of sauce you will use for the pastry is not too much at the bottom of the pastry. For an even browning, try to spread the sauce evenly between the dough sheets and the pastry.

Hints for pastry

- If the pastry is too dry, increase the temperature by 10 °C and shorten the cooking time. Wet the dough sheets with a sauce consisting of milk, oil, egg and yoghurt mixture.
- Bake your pastry in the position and temperature appropriate to the cooking table. If the bottom is still not browned enough, place it on a bottom shelf for the next cooking.

Cooking table for pastries and oven foods

Suggestions for baking with a single tray

Food	Accessory to be used	Operating function	Shelf position	Temperature (°C)	Baking time (min) (approx.)
Cake on the tray	Standard tray *	Top and bottom heating	3	180	30 ... 40
Cake in the mould	Cake mould on wire grill **	Fan Heating	2	180	30 ... 40
Small cakes	Standard tray *	Top and bottom heating	3	160	25 ... 35
Small cakes	Standard tray *	Fan Heating	On models with wire shelves : 3 On models without wire shelves : 2	150	25 ... 35
Sponge cake	Round cake mould, 26 cm in diameter with clamp on wire grill **	Top and bottom heating	2	160	30 ... 40
Sponge cake	Round cake mould, 26 cm in diameter with clamp on wire grill **	Fan Heating	2	160	30 ... 40
Cookie	Pastry tray *	Top and bottom heating	3	170	25 ... 35
Cookie	Pastry tray *	Fan Heating	3	170	20 ... 30
Pastry	Standard tray *	Top and bottom heating	2	200	35 ... 45
Pastry	Standard tray *	Fan Heating	2	180	35 ... 45
Bun	Standard tray *	Top and bottom heating	2	200	20 ... 30

Food	Accessory to be used	Operating function	Shelf position	Temperature (°C)	Baking time (min) (approx.)
Bun	Standard tray *	Fan Heating	3	180	20 ... 30
Whole bread	Standard tray *	Top and bottom heating	3	200	30 ... 40
Whole bread	Standard tray *	Fan Heating	3	200	30 ... 40
Lasagne	Glass / metal rectangular container on wire grill **	Top and bottom heating	2 or 3	200	30 ... 40
Apple pie	Round black metal mould, 20 cm in diameter on wire grill **	Top and bottom heating	2	180	50 ... 70
Apple pie	Round black metal mould, 20 cm in diameter on wire grill **	Fan Heating	2	170	50 ... 70
Pizza	Standard tray *	Top and bottom heating	2	200 ... 220	10 ... 20
Pizza	Standard tray *	Pizza function	2	280	5 ... 10

Suggestions for cooking with two trays

Food	Accessory to be used	Operating function	Shelf position	Temperature (°C)	Baking time (min) (approx.)
Small cakes	2-Standard tray * 4-Pastry tray *	Fan Heating	2 - 4	On models with wire shelves :150 On models without wire shelves :140	On models with wire shelves : 25 ... 40 On models without wire shelves : 30 ... 45
Cookie	2-Standard tray * 4-Pastry tray *	Fan Heating	2 - 4	170	25 ... 35
Pastry	1-Standard tray * 4-Pastry tray *	Fan Heating	1 - 4	180	35 ... 45
Bun	2-Standard tray * 4-Pastry tray *	Fan Heating	2 - 4	180	20 ... 30

Preheating is recommended for all food.

*These accessories may not be included with your product.

**These accessories are not included with your product. They are commercially available accessories.

Cooking table with operating function "Eco fan heating"

- Do not change the temperature setting after starting cooking in the operating function "Eco fan heating".
- Do not open the oven door when cooking in the "Eco fan heating" operating function. If the door does not open, the internal temperature is optimized to save energy, and this temperature may differ from what is shown on the display.
- Do not preheat in the "Eco fan heating" operating function.

Food	Accessory to be used	Shelf position	Temperature (°C)	Baking time (min) (approx.)
Small cakes	Standard tray *	3	160	25 ... 35
Cookie	Standard tray *	3	180	25 ... 35
Pastry	Standard tray *	3	200	45 ... 55
Bun	Standard tray *	3	200	35 ... 45

* These accessories may not be included with your product.

6.1.2 Meat, Fish and Poultry

The key points on grilling

- Seasoning it with lemon juice and pepper before cooking whole chicken, turkey and large pieces of meat will increase cooking performance.
- It takes 15 to 30 minutes more to cook boned meat than fillet by frying.
- You should calculate about 4 to 5 minutes of cooking time per centimetre of the meat thickness.
- After the cooking time is expired, keep the meat in the oven for approximately 10 minutes. The juice of the meat is better distributed to the fried meat and does not come out when the meat is cut.
- Fish should be placed on the medium or low level shelf in a heat resistant plate.
- Cook the recommended dishes in the cooking table with a single tray.

Cooking table for meat, fish and poultry

Food	Accessory to be used	Operating function	Shelf position	Temperature (°C)	Baking time (min) (approx.)
Steak (whole) / Roast (1 kg)	Standard tray *	Top and bottom heating	3	15 mins. 250/ max, after 180 ... 190	60 ... 80
Lamb's shank (1,5-2 kg)	Standard tray *	Top and bottom heating	3	15 mins. 250/ max, after 170	110 ... 120
Fried chicken (1,8-2 kg)	Wire grill * Place one tray on a lower shelf.	Top and bottom heating	2	15 mins. 250/ max, after 190	60 ... 80
Fried chicken (1,8-2 kg)	Wire grill * Place one tray on a lower shelf.	Fan Heating	2	200 ... 220	60 ... 80
Fried chicken (1,8-2 kg)	Wire grill * Place one tray on a lower shelf.	"3D" function	2	15 mins. 250/ max, after 190	60 ... 80
Turkey (5.5 kg)	Standard tray *	Top and bottom heating	1	25 mins. 250/ max, after 180 ... 190	150 ... 210

Food	Accessory to be used	Operating function	Shelf position	Temperature (°C)	Baking time (min) (approx.)
Turkey (5.5 kg)	Standard tray *	"3D" function	1	25 mins. 250/ max, after 180 ... 190	150 ... 210
Fish	Wire grill * Place one tray on a lower shelf.	Top and bottom heating	3	200	20 ... 30
Fish	Wire grill * Place one tray on a lower shelf.	"3D" function	3	200	20 ... 30

Preheating is recommended for all food.

*These accessories may not be included with your product.

**These accessories are not included with your product. They are commercially available accessories.

6.1.3 Grill

Red meat, fish and poultry meat quickly turns brown when grilled, holds a beautiful crust and does not dry out. Fillet meats, skewer meats, sausages as well as juicy vegetables (tomatoes, onions, etc.) are particularly suitable for grilling.

General warnings

- Food not suitable for grilling carries a fire hazard. Grill only food that is suitable for heavy grill fire. Also, do not place the food too far in the back of the grill. This is the hottest area and fatty foods may catch fire.
- **Close the oven door during grilling. Never grill with the oven door open. Hot surfaces may cause burns!**

The key points of the grill

- Prepare foods of similar thickness and weight as much as possible for the grill.
- Place the pieces to be grilled on the wire grill or wire grill tray by distributing them without exceeding the dimensions of the heater.
- Depending on the thickness of the pieces to be grilled, the cooking times given in the table may vary.
- Slide the wire grill or the wire grill tray to the desired level in the oven. If you are cooking on the wire grill, slide the oven tray to the lower shelf to collect the oils. The oven tray you will slide should be sized to cover the entire grill area. This tray may not be supplied with the product. Put some water into the oven tray for easy cleaning.

Grill table

Food	Accessory to be used	Shelf position	Temperature (°C)	Baking time (min) (approx.)
Fish	Wire grill	4 - 5	250	20 ... 25
Chicken pieces	Wire grill	4 - 5	250	25 ... 35
Meatball (veal) - 12 amount	Wire grill	4	250	20 ... 30
Lamb chop	Wire grill	4 - 5	250	20 ... 25
Steak - (meat cubes)	Wire grill	4 - 5	250	25 ... 30
Veal chop	Wire grill	4 - 5	250	25 ... 30
Vegetable gratin	Wire grill	4 - 5	220	20 ... 30
Toast bread	Wire grill	4	250	1 ... 4

It is recommended to preheat for 5 minutes for all grilled food.

Turn pieces of food after 1/2 of the total grilling time.

6.1.4 Test foods

- Foods in this cooking table are prepared according to the EN 60350-1 standard to facilitate testing of the product for control institutes.

Cooking table for test meals

Suggestions for baking with a single tray

Food	Accessory to be used	Operating function	Shelf position	Temperature (°C)	Baking time (min) (approx.)
Shortbread (sweet cookie)	Standard tray *	Top and bottom heating	3	140	20 ... 30
Shortbread (sweet cookie)	Standard tray *	Fan Heating	On models with wire shelves :3 On models without wire shelves :2	140	15 .. 25
Small cakes	Standard tray *	Top and bottom heating	3	160	25 ... 35
Small cakes	Standard tray *	Fan Heating	On models with wire shelves : 3 On models without wire shelves : 2	150	25 ... 35
Sponge cake	Round cake mould, 26 cm in diameter with clamp on wire grill **	Top and bottom heating	2	160	30 ... 40
Sponge cake	Round cake mould, 26 cm in diameter with clamp on wire grill **	Fan Heating	2	160	30 ... 40
Apple pie	Round black metal mould, 20 cm in diameter on wire grill **	Top and bottom heating	2	180	50 ... 70
Apple pie	Round black metal mould, 20 cm in diameter on wire grill **	Fan Heating	2	170	50 ... 70

Suggestions for cooking with two trays

Food	Accessory to be used	Operating function	Shelf position	Temperature (°C)	Baking time (min) (approx.)
Shortbread (sweet cookie)	2-Standard tray * 4-Pastry tray *	Fan Heating	2 - 4	140	15 ... 25
Small cakes	2-Standard tray * 4-Pastry tray *	Fan Heating	2 - 4	On models with wire shelves :150 On models without wire shelves :140	On models with wire shelves : 25 ... 40 On models without wire shelves : 30 ... 45

Preheating is recommended for all food.

*These accessories may not be included with your product.

**These accessories are not included with your product. They are commercially available accessories.

Grill

Food	Accessory to be used	Shelf position	Temperature (°C)	Baking time (min) (approx.)
Meatball (veal) - 12 amount	Wire grill	4	250	20 ... 30
Toast bread	Wire grill	4	250	1 ... 4

It is recommended to preheat for 5 minutes for all grilled food.

Turn pieces of food after 1/2 of the total grilling time.

7 Maintenance and Cleaning

7.1 General Cleaning Information

General warnings

- Wait for the product to cool before cleaning the product. Hot surfaces may cause burns!
- Do not apply the detergents directly on the hot surfaces. This may cause permanent stains.
- The product should be thoroughly cleaned and dried after each operation. Thus, food residues shall be easily cleaned and these residues shall be prevented from burning when the product is used again later. Thus, the service life of the appliance extends and frequently faced problems are decreased.
- Do not use steam cleaning products for cleaning.
- Some detergents or cleaning agents cause damage to the surface. Unsuitable cleaning agents are: bleach, cleaning products containing ammonia, acid or chloride, steam cleaning products, descaling agents, stain and rust removers, abrasive cleaning products (cream cleaners, scouring powder, scouring cream, abrasive and scratching scrubber, wire, sponges, cleaning cloths containing dirt and detergent residues).
- No special cleaning material is needed in the cleaning made after each use. Clean the appliance using dishwashing detergent, warm water and a soft cloth or sponge and dry it with a dry cloth.

- Be sure to completely wipe off any remaining liquid after cleaning and immediately clean any food splashing around during cooking.
- Do not wash any component of your appliance in a dishwasher.

Inox - stainless surfaces

- Do not use acid or chlorine-containing cleaning agents to clean stainless-inox surfaces and handles.
- Stainless-inox surface may change colour in time. This is normal. After each operation, clean with a detergent suitable for the stainless or inox surface.
- Clean with a soft soapy cloth and liquid (non-scratching) detergent suitable for inox surfaces, taking care to wipe in one direction.
- Remove lime, oil, starch, milk and protein stains on the glass and inox surfaces immediately without waiting. Stains may rust under long periods of time.
- Cleaners sprayed/applied to the surface should be cleaned immediately. Abrasive cleaners left on the surface cause the surface to turn white.

Enamelled surfaces

- After each use, clean the enamel surfaces using dishwashing detergent, warm water and a soft cloth or sponge and dry them with a dry cloth.

- If your product has an easy steam cleaning function, you can make easy steam cleaning for light non-permanent dirt. (See “Easy Steam Cleaning [▶ 31]”.)
- For difficult stains, an oven and grill cleaner recommended on the website of your product brand and a non-scratching scouring pad can be used. Do not use an external oven cleaner.
- The oven must cool down before cleaning the cooking area. Cleaning on hot surfaces shall create both fire hazard and damage the enamel surface.

Catalytic surfaces

- The side walls in the cooking area can only be covered with enamel or catalytic walls. It varies by model.
- The catalytic walls have a light matte and porous surface. The catalytic walls of the oven should not be cleaned.
- Catalytic surfaces absorb oil thanks to its porous structure and start to shine when the surface is saturated with oil, in this case it is recommended to replace the parts.

Glass surfaces

- When cleaning glass surfaces, do not use hard metal scrapers and abrasive cleaning materials. They can damage the glass surface.
- Clean the appliance using dishwashing detergent, warm water and a microfiber cloth specific for glass surfaces and dry it with a dry microfiber cloth.
- If there is residual detergent after cleaning, wipe it with cold water and dry with a clean and dry microfiber cloth. Residual detergent may damage the glass surface next time.
- Under no circumstances should the dried-up residue on the glass surface be cleaned off with serrated knives, wire wool or similar scratching tools.

- You can remove the calcium stains (yellow stains) on the glass surface with the commercially available descaling agent, with a descaling agent such as vinegar or lemon juice.
- If the surface is heavily soiled, apply the cleaning agent on the stain with a sponge and wait a long time for it to work properly. Then clean the glass surface with a wet cloth.
- Discolorations and stains on the glass surface are normal and not defects.

Plastic parts and painted surfaces

- Clean plastic parts and painted surfaces using dishwashing detergent, warm water and a soft cloth or sponge and dry them with a dry cloth.
- Do not use hard metal scrapers and abrasive cleaners. They may damage the surfaces.
- Ensure that the joints of the components of the product are not left damp and with detergent. Otherwise, corrosion may occur on these joints.

7.2 Cleaning Accessories

Do not put the product accessories in a dishwasher unless otherwise stated in the user’s manual.

7.3 Cleaning the Control Panel

- When cleaning the panels with knob-control, wipe the panel and knobs with a damp soft cloth and dry with a dry cloth. Do not remove the knobs and gaskets underneath to clean the panel. The control panel and knobs may be damaged.
- While cleaning the inox panels with knob control, do not use inox cleaning agents around the knob. The indicators around the knob can be erased.
- Clean the touch control panels with a damp soft cloth and dry with a dry cloth. If your product has a key lock feature, set the key lock before performing control panel cleaning. Otherwise, incorrect detection may occur on the keys.

7.4 Cleaning the inside of the oven (cooking area)

Follow the cleaning steps described in the "General Cleaning Information" section according to the surface types in your oven.

Cleaning the side walls of the oven

The side walls in the cooking area can only be covered with enamel or catalytic walls. It varies by model. If there is a catalytic wall, refer to the "Catalytic surfaces" section for information.

If your product is a wire shelf model, remove the wire shelves before cleaning the side walls. Then complete the cleaning as described in the "General Cleaning Information" section according to the side wall surface type.

To remove the side wire shelves:

1. Remove the front of the wire shelf by pulling it on the side wall in the opposite direction.
2. Pull the wire shelf towards you to remove it completely.

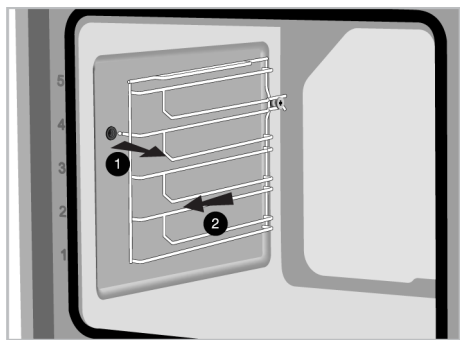

3. To reattach the shelves, the procedures applied when removing them must be repeated from the end to the beginning, respectively.

7.5 Easy Steam Cleaning

This allows cleaning of the dirt (not remaining for a long time) that is softened by the steam inside the oven and by the water droplets condensed in the internal surfaces of the oven easily.

1. Remove all accessories inside the oven.

2. Add 500 ml water into the tray and place it on the 2nd shelf of the oven.

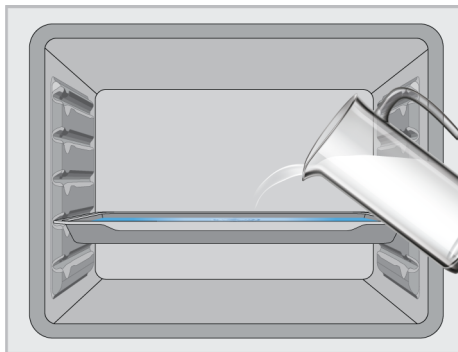

3. Set the oven to the easy steam cleaning operating mode and operate it at 100°C for 15 minutes.

Immediately open the door and wipe the oven interiors with a wet sponge or cloth. Steam will be released when opening the door. This may pose a risk of burns. Be careful when opening the door.

For stubborn dirt, clean the product using dishwashing detergent, warm water and a soft cloth or sponge and dry it with a dry cloth.



In the easy steam cleaning function, it is expected that the added water evaporates and condenses on the inside of the oven and the oven door in order to soften the light dirt formed in your oven. Condensation formed on the oven door may drip around when the oven door is opened. As soon as you open the oven door, wipe off the condensation.

(It varies depending on the product model. It may not be available on your product.) After the condensation inside the oven, puddle or moisture may occur in the pool channel under the oven. Wipe this pool channel with a damp cloth after use and dry it.

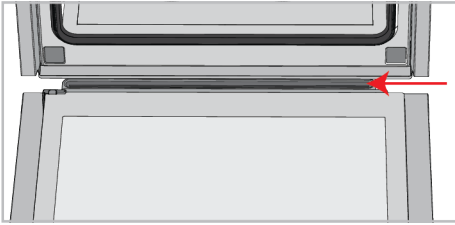

7.6 Cleaning the Oven Door

You can remove your oven door and door glasses to clean them. How to remove the doors and windows is explained in the sections **"Removing the oven door"** and **"Removing the inner glasses of the door"**.

After removing the door inner glasses, clean them using a dishwashing detergent, warm water and a soft cloth or sponge and dry them with a dry cloth. For lime residue that may form on the oven glass, wipe the glass with vinegar and rinse.

i Do not use harsh abrasive cleaners, metal scrapers, wire wool or bleach materials to clean the oven door and glass.

i The oven door inner glass is covered with an easy-to-clean material. Do not use abrasive cleaning agents, hard metal scrapers, wire wool or bleach materials such as bleach.

Removing the oven door

1. Open the oven door.
2. Open the clips in the front door hinge socket on the right and left by pushing them downwards as shown in the figure.
3. Hinge types vary as (A), (B), (C) types according to the product model. The following figures show how to open each type of hinge.
4. (A) type hinge is available in normal door types.

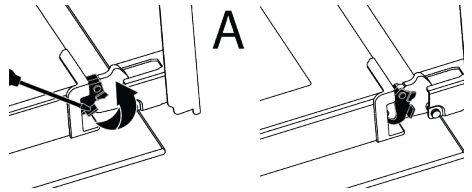

5. (B) type hinge is available in soft closing door types.

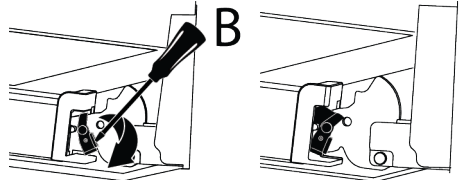

6. (C) type hinge is available in soft opening/closing door types.

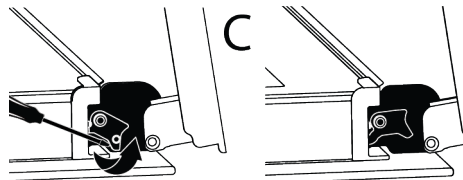

7. Get the oven door to a half-open position.

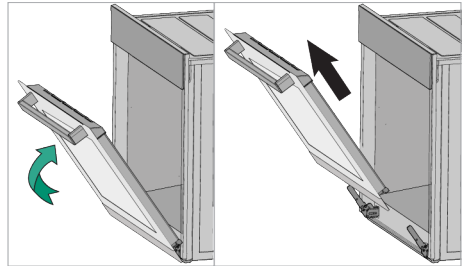

8. Pull the removed door upwards to release it from the right and left hinges and remove it.

i To reattach the door, the procedures applied when removing it must be repeated from the end to the beginning, respectively. When installing the door, be sure to close the clips on the hinge socket.

7.7 Removing the Inner Glass of The Oven Door

Inner glass of the product's front door may be removed for cleaning.

1. Open the oven door.
2. Pull the plastic component, attached on the upper section of the front door, towards yourself by simultaneously pushing on the pressure points on both sides of the component and remove it.

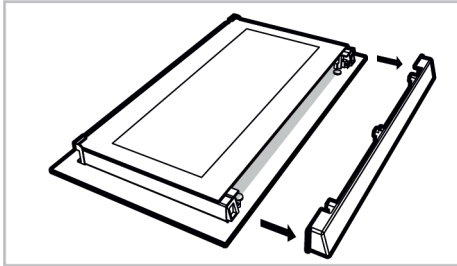
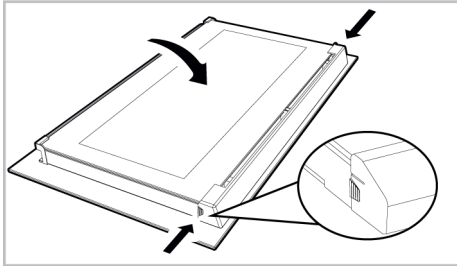

3. As shown in the figure, gently lift the innermost glass (1) towards "A" and then, remove it by pulling towards "B".

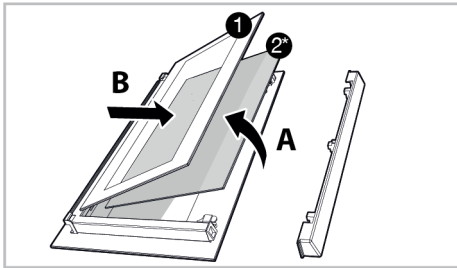

- 1 Innermost glass 2* Inner glass (it may not be available for your product)

4. If your product has an inner glass (2), repeat the same process to detach it (2).

5. The first step of regrouping the door is to reassemble the inner glass (2). Place the bevelled edge of the glass to meet the bevelled edge of the plastic slot. (If your product has an inner glass). Inner glass (2) must be attached to the plastic slot closest to the innermost glass (1).
6. While reassembling the innermost glass (1), pay attention to place the printed side of the glass on the inner glass. It is crucial to place the lower corners of the innermost glass (1) to meet the lower plastic slots.
7. Push the plastic component towards the frame until a "click" sound is heard.

7.8 Cleaning the Oven Lamp

In the event that the glass door of the oven lamp in the cooking area becomes dirty; clean using dishwashing detergent, warm water and a soft cloth or sponge and dry with a dry cloth. In case of oven lamp failure, you can replace the oven lamp by following the sections that follow.

Replacing the oven lamp

General Warnings

- To avoid the risk of electric shock before replacing the oven lamp, disconnect the product and wait for the oven to cool. Hot surfaces may cause burns!
- This oven is powered by an incandescent lamp with less than 40 W, less than 60 mm in height, less than 30 mm in diameter, or a halogen lamp with G9 sockets with less than 60 W power. Lamps are suitable for operation at temperatures above 300 °C. Oven lamps are available from Authorised Services or licensed technicians. This product contains a G energy class lamp.
- The position of the lamp may differ from that is shown in the figure.
- The lamp used in this product is not suitable for use in the lighting of home rooms. The purpose of this lamp is to help the user see food products.

- The lamps used in this product must withstand extreme physical conditions such as temperatures above 50 °C.

If your oven has a round lamp,

1. Disconnect the product from the electricity.
2. Remove the glass cover by turning it counter clockwise.

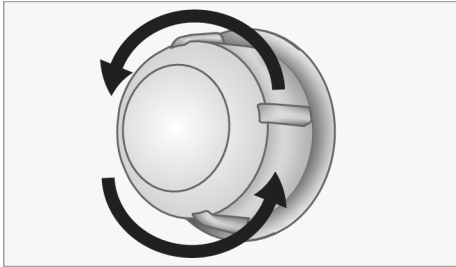

3. If your oven lamp is type (A) shown in the figure below, rotate the oven lamp as shown in the figure and replace it with a new one. If it is type (B) model, pull it out as shown in the figure and replace it with a new one.

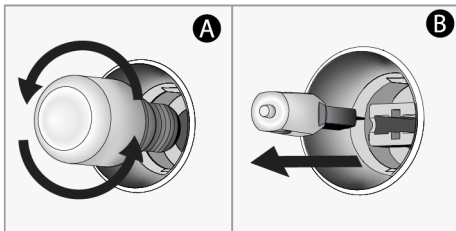

4. Refit the glass cover.

If your oven has a square lamp,

1. Disconnect the product from the electricity.
2. Remove the wire shelves according to the description.

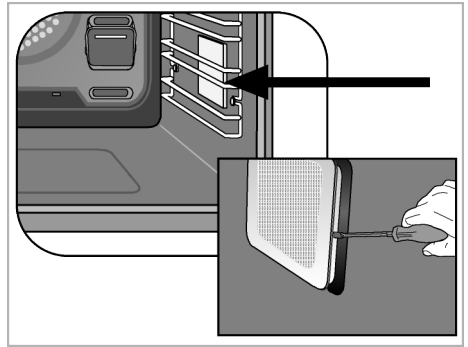

3. Lift the lamp's protective glass cover with a screwdriver. Remove the screw first, if there is a screw on the square lamp in your product.
4. If your oven lamp is type (A) shown in the figure below, rotate the oven lamp as shown in the figure and replace it with a new one. If it is type (B) model, pull it out as shown in the figure and replace it with a new one.

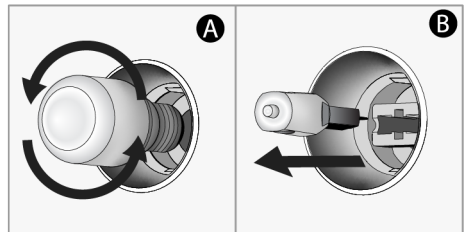

5. Refit the glass cover and wire shelves.

8 Troubleshooting

If the problem persists after following the instructions in this section, contact your vendor or an Authorized Service. Never try to repair your product yourself.

Steam is emanated while the oven is working.

- It is normal to see vapour during operation. >>> This is not an error.

Water droplets appear while cooking

- The steam generated during cooking condenses when it comes into contact with cold surfaces outside the product and may form water droplets. >>> This is not an error.

Metal sounds are heard while the product is warming and cooling.

- Metal parts may expand and make sounds when heated. >>> This is not an error.

The product does not work.

- Fuse may be faulty or blown. >>> Check the fuses in the fuse box. Change them if necessary or reactivate them.
- The appliance may not be plugged to the (grounded) outlet. >>> Check if the appliance is plugged in to the outlet.
- (If there is timer on your appliance) Keys on the control panel do not work. >>> If your product has a key lock, the key lock may be enabled, disable the key lock.

Oven light is not on.

- Oven lamp may be faulty. >>> Replace oven's lamp.

- No electricity. >>> Ensure the mains is operational and check the fuses in the fuse box. Change the fuses if necessary or reactivate them.

Oven is not heating.

- The oven may not be set to a specific cooking function and/or temperature. >>> Set the oven to a specific cooking function and/or temperature.
- For the models with timer, the time is not set. >>> Set the time.
- No electricity. >>> Ensure the mains is operational and check the fuses in the fuse box. Change the fuses if necessary or reactivate them.

(For models with timer) The timer display flashes or the timer symbol is left open.

- There has been a power outage before. >>> Set the time / Turn off the product function knobs and again switch it to the desired position.

BLOMBERG UK AND IRELAND STANDARD MANUFACTURER GUARANTEE TERMS AND CONDITIONS

Your new Blomberg product is guaranteed against faulty materials, defective components or manufacturing defects.

The standard guarantee starts from the date of original purchase of the product, and lasts for a period of thirty six (36) months unless Beko plc (the "Manufacturer") agrees to extend the guarantee for the product in writing.

If you have any questions about the guarantee on your product (including how long it is valid), please contact your retailer or our contact centre on **0333 207 9870** (UK and Northern Ireland) or **01 691 0160** (Republic of Ireland)

This guarantee does not in any way diminish or affect your statutory rights in connection with the product. This guarantee is in addition to your statutory rights as a consumer. If you have any questions about these rights, please contact the retailer from which you purchased the product. In certain circumstances, it is possible that your statutory rights may offer additional or higher levels of protection than those offered under the terms of this guarantee.

What is covered by this guarantee?

- Repairs to the product required as a result of faulty materials, defective components or manufacturing defects.
- Functional replacement parts to repair a product.
- The costs of a Blomberg Approved Engineer to carry out the repair.

What is not covered?

- Transit and delivery damage.
- Cabinet or appearance parts, including but not limited to control knobs, flaps and handles.
- Accessories and/or consumable items including but not limited to ice trays, scrapers, cutlery baskets, filters and light bulbs.
- Repairs necessary as a direct or indirect result of:
 - Accidental damage, misuse or abuse of a product.
 - An attempted repair of a product by anyone other than a Blomberg Approved Engineer (the "Engineer").
 - Installation or use of a product where such installation or use fails to meet the requirements contained in this guarantee or the User Instructions Booklet.
- Repairs to a product operated at any time on commercial or non-residential household premises (unless we have previously agreed to the installation environment).

This guarantee is limited to the cost of repairing the product. To the extent permitted by law, the Manufacturer does not accept and will not be held liable for any financial loss

incurred in connection with the failure of any product to operate in accordance with the expected standards. Such financial loss includes but is not limited to loss arising from:

- Time taken off work.
- Damaged food, clothing or other items.
- Meals taken at restaurants or from takeaways.
- General compensation for inconvenience.

Important Notes

1. Your product is designed and built for domestic household use only.
2. The guarantee will automatically be void if the product is installed or is used in commercial or non-residential domestic household premises, unless we have previously agreed to the installation environment.
3. The product must be correctly installed, located and operated in accordance with the instructions contained in the User Instructions Booklet provided with your product.
4. Professional installation by a qualified Electrical Domestic Appliance Installer is recommended for all Washing Machines, Dishwashers and Electric Cookers (as incorrect installation may result in you having to pay for the cost of repairing the product).
5. Gas Cookers must be professionally installed by a Gas Safe (or Gas Networks Ireland for Republic of Ireland) registered gas installer.
6. This guarantee is given in respect of products purchased and used within the United Kingdom and the Republic of Ireland.
7. This guarantee is effective from the initial date of purchase of a new product from an authorised retailer and will be void if the product is resold.
8. This guarantee does not apply to graded sales (where the product is purchased as a "second").
9. Possession of a copy of these terms and conditions does not necessarily mean that a product has the benefit of this guarantee. If you have any questions, please call our Call Centre on the number set out above.
10. The Manufacturer reserves the right to terminate the guarantee if its staff or representatives are subjected to physical or verbal abuse in the course of carrying out their duties.
11. Optional extras, where available (i.e. extendable feet) are supplied on a chargeable basis only.

Does Blomberg offer replacements?

This is a repair-only guarantee. On occasion, the Manufacturer may at its sole discretion, replace your product with a new product instead of carrying out a repair. Where a replacement is offered, this would normally be an identical model but when this is not possible, a model of similar specification will be provided. The Manufacturer will cover the costs and arrange for the delivery of the new product and for the return of the old product. Any costs related to disconnecting the faulty product and installing the replacement product will not be borne by the Manufacturer unless previously agreed to in writing. The original guarantee will continue to apply to the replacement product; the new product will not come with a new guarantee.

When will the repair take place?

Our Engineers work Monday to Friday 9.00am to 5.00pm. Appointments outside these hours may be possible at the sole discretion of the Manufacturer but cannot be guaranteed. Whilst our Engineers will endeavour to minimize inconvenience and to meet requests for specific timed appointments, this cannot be guaranteed. We will not be liable for delays or if it is unable to carry out a repair because a convenient appointment cannot be arranged.

Will there be any charge for the repairs?

It is your responsibility to provide evidence to the Engineer that your product is covered by this guarantee with a proof of purchase. The Manufacturer reserves the right to charge for the reasonable cost of any service call if:

- You cannot provide evidence that your product is covered by this guarantee.
- Where a service call has been made and the engineer finds that there is no fault with your product.
- That your product has not been installed or operated in accordance with the User Instructions Booklet.
- That the fault was caused by something other than faulty materials, defective components or manufacturing defects.
- For missed appointments.

Payment of these costs are due immediately upon the Engineer providing you with an invoice. The Manufacturer reserves the right to terminate the guarantee if you fail to pay the costs for the service call in a timely manner.

If you are a resident of the United Kingdom, this guarantee will be governed by English law and subject to the English Courts, save where you live in another part of the United Kingdom, in which case the law and courts of that location will apply.

If you are resident in the Republic of Ireland, this guarantee will be governed by Irish law and the Irish courts will have jurisdiction.

This guarantee is provided by Beko plc. Beko House, 1 Greenhill Crescent, Watford, Hertfordshire. WD18 8QU.

Beko plc is registered in England and Wales with company registration number 02415578.

BLOMBERG UK AND IRELAND OPTIMA INVERTER MOTOR GUARANTEE TERMS AND CONDITIONS

This 10 year guarantee relates to Blomberg products that feature the Optima Inverter Motor.

The Optima Motor guarantee terms and conditions are in addition to our Standard guarantee terms and conditions detailed in the previous section.

In order to activate the 10 year guarantee you MUST register the appliance within 90 days of the original purchase date. You can register by first visiting blomberguk.com/register and by following the online instructions.

All Blomberg appliances come with a 3 year parts and labour guarantee as standard. When you register your appliance for the Optima Inverter Motor 10 year guarantee, you are also registering your appliance for the standard 3 year parts and labour guarantee.

Blomberg built-in or integrated products purchased from Euronics agents come with a 3 year parts and labour guarantee which is extended to 5 years, free of charge, upon registration of the appliance. When you register your appliance for this additional 2 years, you will automatically activate the Optima Inverter Motor 10 year guarantee. You do not need to register twice. To make a claim against your Blomberg Optima Inverter Motor Guarantee (the "Guarantee"), all customer and product details must be registered with Beko plc using the procedure outlined below.

1. This extra 7 years or 5 years (for built-in appliances from Euronics agents) Guarantee is only effective after the expiration of the standard manufacturer's guarantee.
2. It is only valid for the Optima Inverter motors of selected washing machines, washer-dryers, tumble dryers and dishwashers. It does not cover any labour charge or any other components of the product. In addition, it is only valid for one replacement of the Optima motor during the extra 9-year (for free standing appliances) or 8 year (for built-in appliances) guarantee period.
3. To activate your guarantee, you MUST register your appliance within 90 days of the original purchase date, by visiting blomberguk.com/register.
4. Customers will receive a unique reference code as proof of guarantee validation by email or post, which must be quoted at the time of a claim being made.
5. Any repair/replacement of the Optima Inverter motor must only be carried out by an authorised Blomberg Service Agent (the "Service Agent").
6. Labour for the repair/replacement of the Optima Inverter motor is not included in this guarantee and is chargeable directly by the Service Agent.

7. Any additional components fitted to the product at any time will not be covered by this guarantee and will be chargeable directly by the Service Agent.
8. The guarantee is not transferable and cannot be exchanged for cash.
9. There are no alternative or additional offers to this Guarantee.
10. The guarantee is exclusive of the manufacturer's standard guarantee
11. The Terms and Conditions shown above are in addition to the standard terms and conditions of your product guarantee. Please read and refer to such Terms and Conditions when making any claim.
12. We may use the information you provide for marketing purposes and to analyse your purchasing preferences. We may keep your information for a reasonable period for these purposes in accordance with the applicable Data Protection Laws and General Data Protection Regulations (GDPR). You can opt into this service during the registration process. Further details are available at <http://www.blomberguk.com/cookie-and-privacy>.
13. These Terms and Conditions are governed by the laws of England and Wales; manufacturer: Beko plc, Beko House, 1 Greenhill Crescent, Watford WD18 8QU. Company Registration Number: 02415578.

HOW TO OBTAIN SERVICE FOR YOUR APPLIANCE

Please keep your purchase receipt or other proof of purchase details in a safe place; you will need to have this documentation available should the product require attention under guarantee.

Please take a few moments to complete the details below, as you will need this information when you call us, or to use our online services. When you call us you may be required to input your serial number into your telephone keypad. For help please visit Blomberguk.com/support/model-finder

- The product model number is printed on the Operating Instruction Booklet / User guide
- The product model and serial number is printed on the Rating Label affixed to the appliance.
- The Retailer (Purchased from) and Date of purchase will be printed on your purchase receipt or other proof of purchase paperwork

Recording of these details alone will not count as proof of purchase. A valid proof of purchase is required for requesting service under guarantee.

Model number	Serial number	Purchased from	Date of purchase

For service under guarantee or for product advice please call our Contact centre

Before requesting service please check the troubleshooting guide in the Operating Instructions booklet, as a charge may be levied where no fault is found, and even though your product may still be under guarantee.

After arranging service the area around the product must be easily accessible to the Engineer, without the need for cabinets or furniture to be removed or moved.

It is your responsibility to ensure our Engineers have a clean and safe environment to carry out any repairs.

Please have your Model number and Serial number available when you call us, as you may be required to input your serial number into your telephone keypad during your call.

UK Mainland & Northern Ireland:

0333 207 9870

Landline or mobile calls to 0333 numbers cost no more than calls to geographic numbers 01 or 02, and are charged at the basic rate. Calls from landlines and mobiles are included in free call packages but please check with your telephone service provider for exact call charges.

Republic of Ireland:

01 691 0160

Service once the manufacturers guarantee has expired

If you have purchased an extended guarantee please refer to the instructions contained within the extended guarantee agreement document, otherwise please call us using the appropriate number above, where service can be obtained at a charge.

Should you experience any difficulty in obtaining service please call us on **0333 207 9870** or **01 691 0160**

Contact us through our website

Send us a secure message through our online contact us form. Please visit our website, click Contact Us and choose a product support topic from the list of options. Complete the required details and click send message.

Product registrations

For UK and Republic of Ireland product registrations please visit blomberguk.com/register

