

**BEKO**

*installation, operation &  
food storage instructions*

**TFF 577APW**



get the **best** from your new refrigerator

## **Please read this manual first!**

Dear Customer,

We hope that your product, which has been produced in a 1st-class manufacturing facility and checked under the most meticulous quality control procedures, will provide you with years of good service.

For this, we recommend you to carefully read the entire manual of your product before using it and keep it at hand for future reference.



### **This manual**

- Will help you use your appliance quickly and safely.
- Read the manual before installing and operating your product.
- Follow the instructions, especially those for safety.
- Keep the manual in an easily accessible place as you may need it later.
- Besides, read also the other documents provided with your product.

Please note that this manual may be valid for other models as well.

### **Symbols and their descriptions**

This instruction manual contains the following symbols:

-  Important information or useful usage tips.
-  Warning against dangerous conditions for life and property.
-  Warning against electric voltage.



This product is supplied with the selective sorting symbol for waste electrical and electronic equipment (WEEE).

This means that this product must be handled pursuant to European Directive 2002/96/EC in order to be recycled or dismantled to minimise its impact on the environment. For further information, please contact your local or regional authorities.

Electronic products not included in the selective sorting process are potentially dangerous for the environment and human health due to the presence of hazardous substances.

---

**1 Your refrigerator 3**

**2 Warnings 4**

Electrical Requirements ..... 5  
Warning! This Appliance Must Be Earthed ..... 5  
Energy Saving Tips ..... 6

**3 Installation 7**

Installation Instructions ..... 7  
Caution ..... 11

**4 Before operating 12**

Starting ..... 12

**5 Using your refrigerator 13**

Setting the operating temperature ...  
Indicator lights .....  
Making ice cubes .....  
Defrosting of the appliance .....  
Freezing Fresh Food ..... 14  
Storing Frozen Food ..... 14  
Making Ice Cubes ..... 14  
Defrosting ..... 15

**6 Maintenance and cleaning 16**

Protection of plastic surfaces ..... 16

**7 Recommended solutions for the problems 17**

**8 GUARANTEE DETAILS 20**

**9 How to obtain service 21**

# 1 Your refrigerator

Congratulations on your choice of a BEKO quality Appliance which has been designed to give you service for many years.

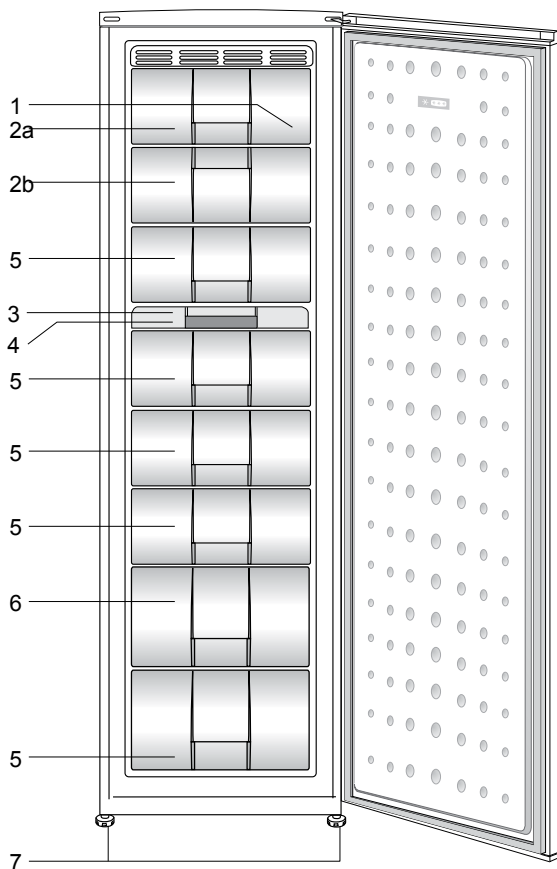

- |                             |                          |
|-----------------------------|--------------------------|
| 1. Thermostat (inside)      | 4. Ice cube tray         |
| 2. Fast freeze compartments | 5. Standard drawers      |
| 2a. Lift up flap            | 6. Extra large drawer    |
| 2b. Drop down flap          | 7. Adjustable front feet |
| 3. Ice bank                 |                          |

**I** Figures that take place in this instruction manual are schematic and may not correspond exactly with your product. If the subject parts are not included in the product you have purchased, then it is valid for other models.

## 2 Warnings

---

- Do not connect your appliance to the electricity supply until all packing and transit protectors have been removed.
- If transported horizontally leave to stand upright for at least 4 hours before switching on to allow compressor oil to settle
- If you are discarding an old refrigerator with a lock or latch fitted to the door, disable the lock/latch, ensure that it is left in a safe condition to prevent the entrapment of young children.
- This fridge/freezer must only be used for its intended purpose i.e the storing and freezing of edible foodstuff.
- Do not dispose of the appliance on a fire. At **BEKO**, the care and protection of our environment is an ongoing commitment. This appliance which is among the latest range introduced is particularly environment friendly. Your appliance contains non CFC / HFC natural substances in the cooling system (Called R600a) and in the insulation (Called cyclopentane) which are potentially flammable if exposed to fire. Therefore, take care not to damage, the cooling circuit / pipes of the appliance in transportation and in use. In case of damage do not expose the appliance to fire or potential ignition source and immediately ventilate the room where the appliance is situated.
- We suggest you contact your local authority for disposal information and facilities available.
- See Installation Instructions on on page 7 for information on suitable location.
- To obtain the best possible performance and trouble free operation from your appliance it is very important to carefully read these instructions.
- On delivery, check to make sure that the product is not damaged and that all the parts and accessories are in perfect condition.
- Ensure that the plug remains readily accessible. Do not use multiple adapter or extension cable.
- Failure to observe these instructions may invalidate your right to free service during the guarantee period.
- Keep ventilation openings, in the appliance enclosure or in the built-in structure, clear of obstruction.
- Do not use mechanical devices or other means to accelerate the defrosting process, other than those recommended by the manufacturer.
- Do not damage the refrigerant circuit.
- Do not use electrical appliances inside the food storage compartments of the appliance, unless they are of the type recommended by the manufacturer.
- We suggest you keep these instructions in a safe place for easy reference.
- This appliance is not intended for use by persons (including children) with reduced physical, sensory or mental capabilities, or lack of experience and knowledge, unless they have been given supervision or instruction concerning use of the appliance by a person responsible for their safety.
- Children should be supervised to ensure that they do not play with the appliance.

## Electrical Requirements

Before you insert the plug into the wall socket make sure that the voltage and the frequency shown on the rating plate inside the appliance corresponds to your electricity supply.

Rating label is on the left hand side of fridge inner liner.

We recommend that this appliance be connected to the mains supply via a suitable switched and fused socket. The appliance must be positioned so that the plug is accessible.

Should the mains lead of the appliance become damaged or should it need replacing at any time, it must be replaced by a special purpose made mains lead which can only be obtained from a **BEKO** Authorised Service Agent.

## Warning! This Appliance Must Be Earthed

If the fitted moulded plug is not suitable for your socket, then the plug should be cut off and an appropriate plug fitted. Destroy the old plug which is cut off as a plug with bared cord could cause a shock hazard if inserted into a socket elsewhere in the house.

The moulded plug on this appliance incorporates a 13 A fuse. Should the fuse need to be replaced an ASTABEAB approved BS 1362 fuse of the same rating must be used. Do not forget to refit the fuse cover. In the event of losing the fuse cover the plug must not be used until a replacement fuse cover has been fitted.

Colour of the replacement fuse cover must be the same colour as that visible on the pin face of the plug. Fuse covers are available from any good electrical store.

## Important! Fitting A Different Plug

As the colours of the wires in the mains lead of this appliance may not correspond with the coloured markings identifying the terminals in your plug proceed as follows: (See diagram).

1. Connect the green-yellow or green (Earth) wire to the terminal in the plug marked 'E' or with the symbol  or coloured green and yellow or green.
2. Connect the blue (Neutral) wire to the terminal in the plug marked 'N' or coloured black.
3. Connect the brown (Live) wire to the terminal in the plug marked 'L' or coloured red.

With alternative plugs a 13 A fuse must be fitted either in the plug or adaptor or in the main fuse box. If in doubt contact a qualified electrician.

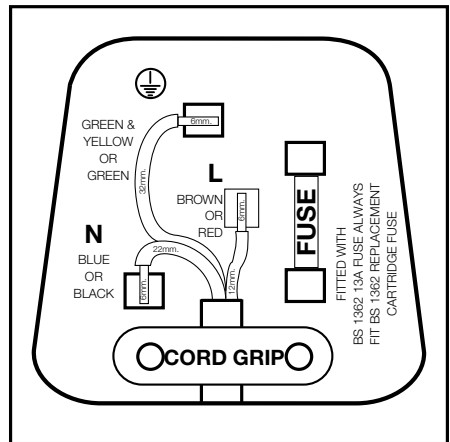

## **Energy Saving Tips**

- 1-** Ensure your appliance is installed in a well ventilated area.
- 2-** Ensure the time between buying chilled/frozen food and placing them in your appliance is kept at minimum, particularly in summer. We recommend you use a cool bag or a special carrier bag to carry frozen food.
- 3-** Do not leave the door (s) of your appliance open longer than necessary and ensure they are closed properly after each opening.
- 4-** Defrost frozen food in the fridge compartment, so that frozen food acts as an ice pack to assist cooling in the fridge.

### 3 Installation

#### Installation Instructions

**1.** The space in the room where the appliance is installed must not be smaller than 10 cubic metres.

**2.** If possible avoid placing the appliance near cookers, radiators or in direct sunlight as this will cause the compressor to run for long periods. If installed next to a source of heat or refrigerator, maintain the following minimum side clearances:

From Cookers                    2" (50 mm)

From Radiators                12" (300 mm)

From Refrigerators or Freezers   1" (25 mm)

**3.** Make sure that sufficient room is provided around the appliance to ensure free air circulation. Allow a minimum of 60 mm (2.4 inches) between the top of the appliance and the ceiling or the underside of a wall cupboard.

**4.** Fit the two plastic wall spacers supplied onto the condenser at the back of the appliance by rotating them 1/4 turn.

**5.** The appliance should be located on

a smooth surface.

The two front feet can be adjusted as required.

To ensure that your appliance is standing upright adjust the two front feet by turning clockwise or anti-clockwise, until the product is in firm contact with the floor. Correct adjustment of feet avoids excessive vibration and noise.

**6.** Refer to "Cleaning and Care" section to prepare your appliance for use.

**7.** A special receptacle is supplied to store the mains plug during transit.

The receptacle is fixed at the back of the cabinet, on the right hand side of the compressor. (See diagram) Gently remove the plug from the receptacle. Never pull the mains cord, you may damage the appliance. In the case of transportation, ensure you locate the plug in the receptacle provided to avoid transit damage. transit provided to avoid transit damage.

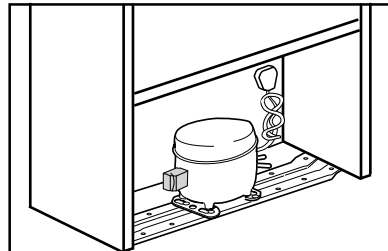
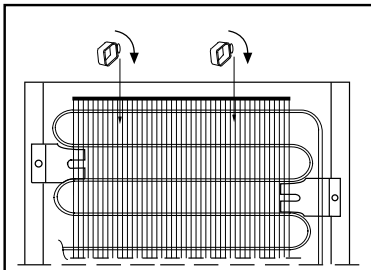



## REVERSING THE DOOR

We recommend that you reverse the door before switching on for the first time.

Tools required: Small and medium size flat and cross-headed screwdrivers, a pair of pliers.

Spare Parts supplied in the plastic bag: The following parts, which are exclusively for left hand side fitted hinge operation are supplied in a plastic bag with the appliance:

- Door top trim hinge covers – there are 2 different parts, one for each side of top trim.

We suggest you keep all the parts supplied in the plastic bag and also parts, which have been removed when reversing the door, in a safe place for possible future, re-use.

**IMPORTANT:** We suggest you ask somebody to help you when moving the appliance around and to hold the door when removing / re-fitting hinges and the door to avoid any injury and damage to the product.

Please refer to diagrams supplied. To follow numbers in brackets below, refer to the main diagram.

1.Switch off the appliance at the socket outlet and pull out the mains plug.

2.Remove all loose items and fittings and food inside the appliance.

3.Gently prise off plastic hinge covers on both sides of front top panel using a small flat-headed screwdriver. (1-2)

4-Unscrew the bolts of the top hinge and remove top hinge. (3)

5-Remove door carefully off the bottom hinge and stand door upright in a safe place.(4)

6.Gently prise off plastic hinge cover on door top trim. Fit the other door top trim plastic off hinge cover supplied in the plastic bag.(5)

7.Gently tilt the appliance back against a strong wall on its rear side sufficiently to allow the lower hinge to be removed. Take care to protect the appliance, your wall and floor coverings. You can utilise the original packaging to do this.Once you tilt the appliance back, check to make sure the appliance is completely stable and safe before you carry on. (6)

8.Unscrew and remove the front feet and 1 bolt. (7)

9-Unscrew and remove the bottom hinge. (8)

10-Unscrew and remove the bottom hinge door stopper and bushing and reposition them on the other side while rotating the bushing 180°. (9)

11-Fit the bottom hinge and tighten the screws as shown in figure. (10)

12-Fit the other front feet as shown in figure. (11)

13-Rotate the top hinge 180°.

Unscrew the hinge pin and re-tighten it to the opposite side. (12)

14-Fit the top hinge on the left hand side bushing of the door. (13)

15-Locate and re-fit door to bottom hinge pin. (14)

16-Re-fit the upper hinge on the opposite side by using a flat headed screwdriver. (15)

17.Fit front top panel plastic hinge covers on the opposite sides. (16)

18-Adjust the two front feet if necessary.

19-Check that door opens and closes easily, it is aligned correctly and there are no gaps allowing air into the cabinet. If there are gaps between the door seal and the cabinet, adjust the door seal by gently pulling away from the door using fingers.

20-Check that all the hinge screws are tightened. Avoid over tightening the screws.

21-Put all items, fittings back in the appliance.

22-Wait for at least 4 hours to allow the system to settle before switching on.

23-Once the correct storage temperatures have been reached in the appliance, put back all the food.

(12)

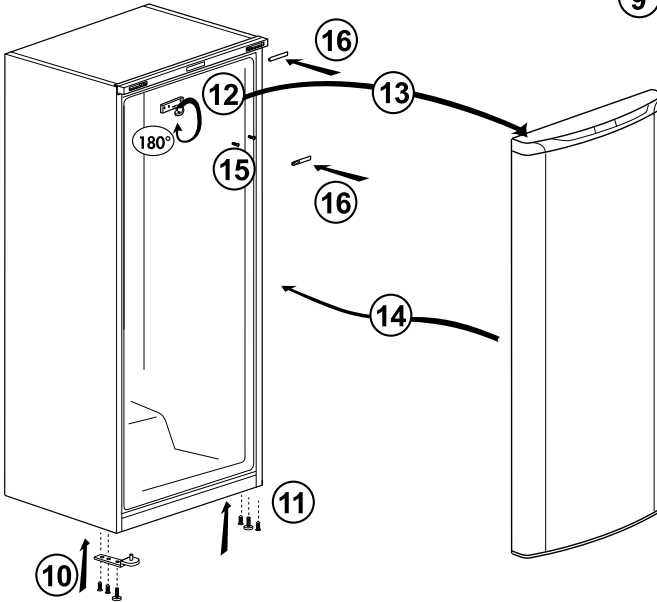
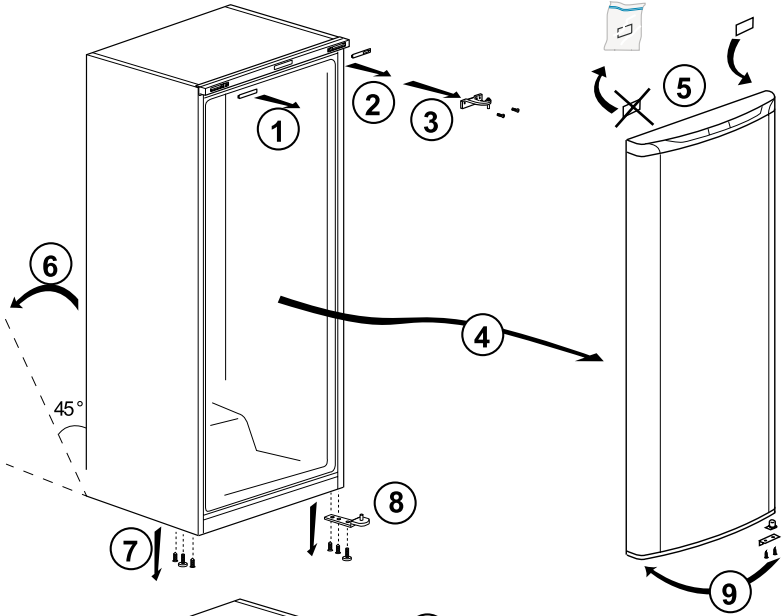
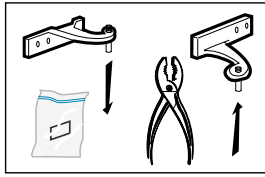

## **Caution**

If you try to reopen the door soon after closing it you will notice that it can require a lot more force than usual and this may cause the product to tilt towards you if pulled excessively, care should be taken if reopening.

This is caused by warm air entering as the door opens. After the door is closed the warm air cools rapidly causing a partial vacuum which makes it difficult to reopen the door.

If you wait a moment or two the pressure soon equalises and the door will be easy to open again.

## 4 Before operating

### Starting

#### Final Check

Before you start using the refrigerator check that:

- 1.The front feet have been adjusted so the appliance is level.
- 2.The interior is dry and air can circulate freely at the rear.
- 3.Clean the interior as recommended under "CLEANING AND CARE."
- 4.Insert the plug into the wall socket and switch on the electricity supply. Avoid accidental disconnection by taping over the switch. Green light will glow and the compressor will start running in about five minutes.
- 5.You will hear a noise as the compressor starts up. The liquid and gases sealed within the refrigeration system may also give rise to noise, whether the compressor is running or not which is quite normal.  
6.If you are going to store frozen food open the freezer door and check that the fast-freeze mode is off. ( thermostat is not set to maximum position ). When temperature reaches -18 °C or below, you can put in your frozen food.  
(See Storing Frozen Food ).
- 7.If you are going to freeze fresh food, you must switch the thermostat to maximum position you must wait at least three hours before putting in your fresh food to be frozen. (See Freezing Fresh Food)
- 8.Front edges of the cabinet may feel warm. This is normal. These areas are designed to be warm to avoid condensation.

9.We recommend that you set the thermostat at MIN setting and monitor the temperature to ensure the appliance maintains desired storage temperatures (See Temperature Control and Adjustment section).

#### Important Note :

- 1.If there is a power failure do not open the door. Frozen food should not be affected if the failure lasts for less than 11 hours. If the failure is longer, then the food should be checked and either eaten immediately or cooked and then re-frozen.
- 2.If you find the freezer door difficult to open just after you have closed it, don't worry. This is due to the pressure difference which will equalise and allow the door to open normally after a few moments.
- 3.You will hear a vacuum sound just after closing the door. This is quite normal.
4. When you switch on, the appliance will not start immediately, because the appliance incorporates a protection device in the electronics - wait for about 5 minutes.
- 5.If you try to reopen the door after closing you will notice that it can require a lot more force than usual, please see page 5 for more information.

## 5 Using your refrigerator

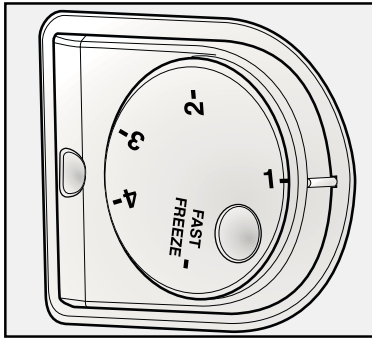

**i** This appliance is equipped with 'Freezer Guard' which ensures that at the advised setting [4 - four on the control] the frozen food in the freezer will not defrost even if the ambient temperature falls as low as  $-15^{\circ}\text{C}$ . So you may then install your appliance in a garage or an unheated room without having to worry about frozen food in the freezer being spoilt.

Operating temperatures are controlled by the thermostat (see diagram) located on the inner side wall of the freezer compartment. Settings may be made from 1, 2 ... fast freeze, fast freeze being the coldest position.

When the appliance is switched on for the first time, the thermostat setting should be adjusted so that after 24 hours, the average freezer temperature is no higher than  $-18^{\circ}\text{C}$  ( $0^{\circ}\text{F}$ ). We recommend you set the setting half way between the 1 and 4 setting. Lower temperatures may be obtained by adjusting setting towards fast freeze position.

We recommend that you check the temperature with an accurate thermometer to ensure that the storage compartments are kept to the desired temperature.

Remember you must take your reading very quickly since the thermometer temperature will rise very rapidly after you remove it from the freezer.

Please remember each time the door is opened cold air escapes and the internal temperature rises. Therefore never leave the door open and ensure it is closed immediately after food is put in or removed.

## Freezing Fresh Food

Please observe the following instructions to obtain the best results.

Do not freeze too large a quantity at any one time. The quality of the food is best preserved when it is frozen right through to the core as quickly as possible.

Do not exceed the freezing capacity of your appliance in 24 h which is 10 kg (22 lb)

Placing warm food into the freezer compartment causes the refrigeration compressor to operate continuously until the food is frozen solid.

If you are going to freeze fresh food in excess of 2kg. (4.5 lb) turn the thermostat to the fast freeze position and wait for about 24 hours before placing the fresh food in the freezer. Remember to turn the thermostat back to its previous position once food has frozen.

It is recommended to place fresh food to be frozen in one of the fast freeze compartments.

## Storing Frozen Food

Prepacked commercially frozen food should be stored in accordance with the frozen food manufacturer's instructions for a  frozen food storage compartment.

To ensure that the high quality achieved by the frozen food manufacturer and the food retailer is maintained the following should be remembered:

1. Put packets in the freezer as quickly as possible after purchase.
2. Do not exceed "Use By", "Best Before" dates on the packaging.

## Making Ice Cubes

Fill the ice-cube tray 3/4 full with water and place it on the special Ice Bank. Store ice-cubes in the Ice Bank.

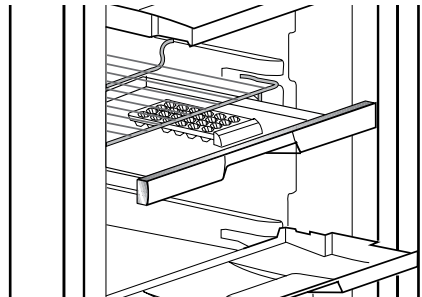

## Defrosting

The appliance defrosts automatically.

The defrost water drains into a plastic reservoir at the back of the appliance and evaporates automatically.

Ensure that the reservoir is fixed properly above the compressor.

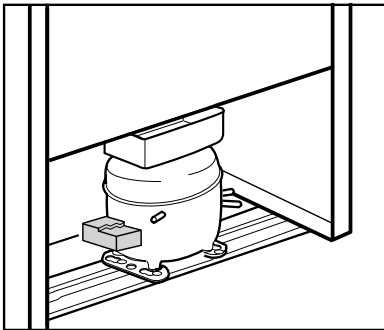



## 6 Maintenance and cleaning

---

- ⚠ Never use gasoline, benzene or similar substances for cleaning purposes.
- ⚠ We recommend that you unplug the appliance before cleaning.
- ⚠ Never use any sharp abrasive instrument, soap, household cleaner, detergent and wax polish for cleaning.
- ℹ Use lukewarm water to clean the cabinet of your refrigerator and wipe it dry.
- ℹ Use a damp cloth wrung out in a solution of one teaspoon of bicarbonate of soda to one pint of water to clean the interior and wipe it dry.
- ⚠ Make sure that no water enters the lamp housing and other electrical items.
- ⚠ If your refrigerator is not going to be used for a long period of time, unplug the power cable, remove all food, clean it and leave the door ajar.
- ℹ Check door seals regularly to ensure they are clean and free from food particles.
- ⚠ To remove door racks, remove all the contents and then simply push the door rack upwards from the base.

### Protection of plastic surfaces

- ℹ Do not put the liquid oils or oil-cooked meals in your refrigerator in unsealed containers as they damage the plastic surfaces of your refrigerator. In case of spilling or smearing oil on the plastic surfaces, clean and rinse the relevant part of the surface at once with warm water.

## 7 Recommended solutions for the problems

Please review this list before calling the service. It might save you time and money. This list includes frequent complaints that are not arising from defective workmanship or material usage. Some of the features described here may not exist in your product.

### The refrigerator does not operate.

- Is the refrigerator properly plugged in? Insert the plug to the wall socket.
- Is the fuse of the socket which your refrigerator is connected to or the main fuse blown out? Check the fuse.

### Condensation on the side wall of the fridge compartment (MULTIZONE, COOL CONTROL and FLEXI ZONE).

- Very cold ambient conditions. Frequent opening and closing of the door. Highly humid ambient conditions. Storage of food containing liquid in open containers. Leaving the door ajar. Switching the thermostat to a colder degree.
- Decreasing the time the door left open or using it less frequently.
- Covering the food stored in open containers with a suitable material.
- Wipe the condensation using a dry cloth and check if it persists.

### Compressor is not running

- Protective thermic of the compressor will blow out during sudden power failures or plug-out plug-ins as the refrigerant pressure in the cooling system of the refrigerator has not been balanced yet. Your refrigerator will start running approximately after 6 minutes. Please call the service if the refrigerator does not startup at the end of this period.
- The fridge is in defrost cycle. This is normal for a full-automatically defrosting refrigerator. Defrosting cycle occurs periodically.
- Your refrigerator is not plugged into the socket. Make sure that the plug is properly fit into the socket.
- Are the temperature adjustments correctly made?
- Power might be cut off.

The fridge is running frequently or for a long time.

- Your new product may be wider than the previous one. This is quite normal. Large refrigerators operate for a longer period of time.
- The ambient room temperature may be high. This is quite normal.
- The refrigerator might have been plugged in recently or might have been loaded with food. Cooling down of the refrigerator completely may last for a couple of hours longer.
- Large amounts of hot food might have been put in the refrigerator recently. Hot food causes longer running of the refrigerator until they reach the safe storage temperature.
- Doors might have been opened frequently or left ajar for a long time. The warm air that has entered into the refrigerator causes the refrigerator to run for longer periods. Open the doors less frequently.
- Freezer or fridge compartment door might have been left ajar. Check if the doors are tightly closed.
- The refrigerator is adjusted to a very low temperature. Adjust the refrigerator temperature to a warmer degree and wait until the temperature is achieved.
- Door seal of the fridge or freezer may be soiled, worn out, broken or not properly seated. Clean or replace the seal. Damaged/broken seal causes the refrigerator to run for a longer period of time in order to maintain the current temperature.

Freezer temperature is very low while the fridge temperature is sufficient.

- The freezer temperature is adjusted to a very low temperature. Adjust the freezer temperature to a warmer degree and check.

Fridge temperature is very low while the freezer temperature is sufficient.

- The fridge temperature might have been adjusted to a very low temperature. Adjust the fridge temperature to a warmer degree and check.

Food kept in the fridge compartment drawers are freezing.

- The fridge temperature might have been adjusted to a very low temperature. Adjust the fridge temperature to a warmer degree and check.

Temperature in the fridge or freezer is very high.

- The fridge temperature might have been adjusted to a very high degree. Fridge adjustment has an effect on the temperature of the freezer. Change the temperature of the fridge or freezer until the fridge or freezer temperature reaches to a sufficient level.
- Doors might have been opened frequently or left ajar for a long time; open them less frequently.
- Door might have been left ajar; close the door completely.
- Large amount of hot food might have been put in the refrigerator recently. Wait until the fridge or freezer reaches the desired temperature.
- The refrigerator might have been plugged in recently. Cooling down of the refrigerator completely takes time.

The operation noise increases when the refrigerator is running.
<ul style="list-style-type: none"> <li>The operating performance of the refrigerator may change due to the changes in the ambient temperature. It is normal and not a fault.</li> </ul>
Vibrations or noise.
<ul style="list-style-type: none"> <li>The floor is not even or it is weak. The refrigerator rocks when moved slowly. Make sure that the floor is strong enough to carry the refrigerator, and level.</li> <li>The noise may be caused by the items put onto the refrigerator. Items on top of the refrigerator should be removed.</li> </ul>
There are noises coming from the refrigerator like liquid spilling or spraying.
<ul style="list-style-type: none"> <li>Liquid and gas flows happen in accordance with the operating principles of your refrigerator. It is normal and not a fault.</li> </ul>
There is a noise like wind blowing.
<ul style="list-style-type: none"> <li>Fans are used in order to cool the refrigerator. It is normal and not a fault.</li> </ul>
Condensation on the inner walls of refrigerator.
<ul style="list-style-type: none"> <li>Hot and humid weather increases icing and condensation. It is normal and not a fault.</li> <li>Doors might have been left ajar; make sure that the doors are closed fully.</li> <li>Doors might have been opened frequently or left ajar for a long time; open them less frequently.</li> </ul>
Humidity occurs on the outside of the refrigerator or between the doors.
<ul style="list-style-type: none"> <li>There might be humidity in the air; this is quite normal in humid weather. When the humidity is less, condensation will disappear.</li> </ul>
Bad odour inside the refrigerator.
<ul style="list-style-type: none"> <li>Inside of the refrigerator must be cleaned. Clean the inside of the refrigerator with a sponge, lukewarm water or carbonated water.</li> <li>Some containers or package materials might cause the smell. Use a different container or different brand packaging material.</li> </ul>
The door is not closing.
<ul style="list-style-type: none"> <li>Food packages may prevent the door's closing. Replace the packages that are obstructing the door.</li> <li>The refrigerator is not completely upright on the floor and rocking when slightly moved. Adjust the elevation screws.</li> <li>The floor is not level or strong. Make sure that the floor is level and capable to carry the refrigerator.</li> </ul>
Crispers are stuck.
<ul style="list-style-type: none"> <li>The food might be touching the ceiling of the drawer. Rearrange food in the drawer.</li> </ul>

## 8 GUARANTEE DETAILS

---

### GUARANTEE DETAILS

Your new Beko product is guaranteed against the cost of breakdown repair for twelve months from the date of the original purchase.

#### What is covered?

- Repairs necessary as a result of faulty materials, defective components or manufacturing defect.
- The cost of functional replacement parts, but excluding consumable items.
- The labour costs of a Beko approved repairer to carry out the repair.

#### What is not covered?

- Transit, delivery or accidental damage or misuse and abuse.
- Cabinet or appearance parts, including control knobs, flaps, handles or container lids.
- Accessories or consumable items including but not limited to, ice trays, scrapers, cutlery baskets, filters and light bulbs.
- Repairs required as a result of unauthorised repair or inexperienced installation that fails to meet the requirements contained in the user instruction book.
- Repairs to products used on commercial or non-residential household premises.
- Loss of frozen food in freezers or fridge/freezers. (Food loss insurance is often included within your household contents insurance policy, or may be available separately from your retailer).

#### Important notes.

- Your Beko product is designed and built for domestic household use only.
- The guarantee will be void if the product is installed or used in commercial or non-residential domestic household premises.
- The product must be correctly installed, located and operated in accordance with the instructions contained in the User Instructions Booklet provided.
- Professional installation by a qualified Electrical Domestic Appliance Installer is recommended for all Washing Machines, Dishwashers and Electric Cookers
- Gas Cookers must only be installed by a Gas Safe (or BORD GAIS) registered Gas Installer.
- The guarantee is given only within the boundaries of the United Kingdom and the Republic of Ireland.
- The guarantee is applicable only to new products and is not transferable if the product is resold.
- Beko disclaims any liability for incidental or consequential damages.  
The guarantee does not in anyway diminish your statutory or legal rights.

## 9 How to obtain service

---

### HOW TO OBTAIN SERVICE

**Please keep your purchase receipt or other proof of purchase in a safe place; you will need to have it should the product require attention under guarantee.**

You should also complete the details below; it will help us assist you when requesting service. (The model number is printed on the Instruction Booklet and the serial number is printed on the Rating Label affixed to the appliance)

**Model No:      Serial No:      Retailer:      Date of purchase:**

**For service under guarantee simply telephone the appropriate number below**

#### **UK Mainland & Northern Ireland**

Fridges & Freezers	0845 6004903
Electric Cookers	0845 6004902
Gas & Dual Fuel Cookers	0845 6004905
Washing Machines & Dishwashers	0845 6004906

#### **Republic of Ireland**

All Refrigeration, All Cookers Washing Machines & Dishwashers	01 862 3411
--	-------------

**Before requesting service please check the trouble-shooting guide in the Operating Instructions as a charge may be levied where no fault is found even though your product may still be under guarantee.**

#### **Service once the manufacturers guarantee has expired.**

If you have purchased an extended guarantee please refer to the instructions contained within the extended guarantee agreement document. Otherwise please call the appropriate number above where service can be obtained at a charge.

Should you experience any difficulty in obtaining service please contact the Beko Customer Help-Line. Tel: 0845 6004911 e-mail: [service@beko.co.uk](mailto:service@beko.co.uk)

# BEKO



BEKO plc  
Beko House  
Caxton Way  
Watford  
Hertfordshire  
WD18 8UF  
Tel: 0845 6004911  
Fax: 0845 6004922  
e-mail: [service@beko.co.uk](mailto:service@beko.co.uk)  
website: [www.beko.co.uk](http://www.beko.co.uk)

Printed in Turkey

Part no: **57 1561 0000**  
Revision no: **AD**