

BEKO

*installation, operation &
food storage instructions*

**Tall Freezer
TFF685APW**



get the **best** from your new refrigerator

Please read this manual first!

Dear Customer,

We hope that your product, which has been produced in modern factories and checked under the most meticulous quality control procedures, will provide you with years of good service.

For this, we recommend you to carefully read the entire manual of your product before using it and keep it at hand for future reference.



This manual

- Will help you use your appliance quickly and safely.
- Read the manual before installing and operating your product.
- Follow the instructions, especially those for safety.
- Keep the manual in an easily accessible place as you may need it later.
- Besides, read also the other documents provided with your product.

Please note that this manual may be valid for other models as well.

Symbols and their descriptions

This instruction manual contains the following symbols:

-  Important information or useful usage tips.
-  Warning against dangerous conditions for life and property.
-  Warning against electric voltage.



This product is supplied with the selective sorting symbol for waste electrical and electronic equipment (WEEE).

This means that this product must be handled pursuant to European Directive 2002/96/EC in order to be recycled or dismantled to minimise its impact on the environment. For further information, please contact your local or regional authorities.

Electronic products not included in the selective sorting process are potentially dangerous for the environment and human health due to the presence of hazardous substances.

CONTENTS

1 Your refrigerator 3

2 Warnings 4

ELECTRICAL REQUIREMENTS.....	5
WARNING! THIS APPLIANCE MUST BE EARTHED	5
Energy Saving Tips.....	6

3 Installation 7

Transportation Instructions.....	7
INSTALLATION INSTRUCTIONS....	7
REVERSING THE DOORS.....	9

4 Before operating 12

STARTING.....	12
---------------	----

5 Using your refrigerator 13

Setting the operating temperature	13
Indicator lights	14
Making ice cubes	15
Defrosting of the appliance	15

6 Maintenance and cleaning 16

7 Do's and Don'ts 17

PROBLEM SOLVING	18
-----------------------	----

1 Your refrigerator

Congratulations on your choice of a BEKO quality Appliance which has been designed to give you service for many years.

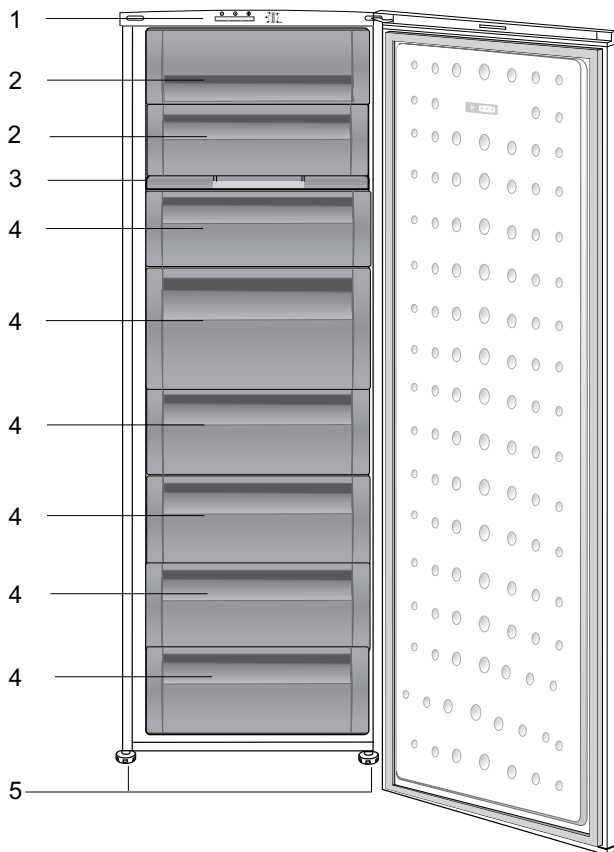

1. Control Panel
2. Flap (Fast-Freeze compartment)
3. Ice cube tray & Ice bank
4. Drawers
5. Adjustable front feet

i Figures that take place in this instruction manual are schematic and may not correspond exactly with your product. If the subject parts are not included in the product you have purchased, then it is valid for other models.

2 Warnings

- DO NOT connect your appliance to the electricity supply until all packing and transit protectors have been removed.
- If transported horizontally leave to stand upright for at least 4 hours before switching on to allow compressor oil to settle .
- If you are discarding an old refrigerator with a lock or latch fitted to the door, disable the lock/latch, ensure that it is left in a safe condition to prevent the entrapment of young children.
- This fridge/freezer must only be used for its intended purpose i.e the storing and freezing of edible foodstuff.
- Do not dispose of the appliance on a fire. At **BEKO**, the care and protection of our environment is an ongoing commitment. This appliance which is among the latest range introduced is particularly environment friendly. Your appliance contains non CFC / HFC natural substances in the cooling system (Called R600a) and in the insulation (Called cyclopentane) which are potentially flammable if exposed to fire. Therefore, take care not to damage, the cooling circuit / pipes of the appliance in transportation and in use. In case of damage do not expose the appliance to fire or potential ignition source and immediately ventilate the room where the appliance is situated.
- We suggest you contact your local authority for disposal information and facilities available.
- See Installation Instructions on page 6 for information on suitable location.
- To obtain the best possible performance and trouble free operation from your appliance it is very important to carefully read these instructions.
- On delivery, check to make sure that the product is not damaged and that all the parts and accessories are in perfect condition.
- Ensure that the plug remains readily accessible. Do not use multiple adapter bar or extension cable.
- Failure to observe these instructions may invalidate your right to free service during the guarantee period.
- Keep ventilation openings, in the appliance enclosure or in the built-in structure, clear of obstruction.
- Do not use mechanical devices or other means to accelerate the defrosting process, other than those recommended by the manufacturer.
- Do not damage the refrigerant circuit.
- Do not use electrical appliances inside the food storage compartments of the appliance, unless they are of the type recommended by the manufacturer.
- We suggest you keep these instructions in a safe place for easy reference.
- This appliance is not intended for use by persons (including children) with reduced physical, sensory or mental capabilities, or lack of experience and knowledge, unless they have been given supervision or instruction concerning use of the appliance by a person responsible for their safety.
- Children should be supervised to ensure that they do not play with the appliance.

ELECTRICAL REQUIREMENTS

Before you insert the plug into the wall socket make sure that the voltage and the frequency shown on the rating plate inside the appliance corresponds to your electricity supply.

Rating label is on the left hand side of fridge inner liner.

We recommend that this appliance be connected to the mains supply via a suitable switched and fused socket. The appliance must be positioned so that the plug is accessible.

Should the mains lead of the appliance become damaged or should it need replacing at any time, it must be replaced by a special purpose made mains lead which can only be obtained from a BEKO Authorised Service Agent.

WARNING! THIS APPLIANCE MUST BE EARTHED

If the fitted moulded plug is not suitable for your socket, then the plug should be cut off and an appropriate plug fitted. Destroy the old plug which is cut off as a plug with bared cord could cause a shock hazard if inserted into a socket elsewhere in the house.

The moulded plug on this appliance incorporates a 13 A fuse. Should the fuse need to be replaced an ASTABEAB approved BS 1362 fuse of the same rating must be used. Do not forget to refit the fuse cover. In the event of losing the fuse cover the plug must not be used until a replacement fuse cover has been fitted. Colour of the replacement fuse cover must be the same colour as that visible on the pin face of the plug. Fuse covers are available from any good electrical store.

IMPORTANT! FITTING A DIFFERENT PLUG

As the colours of the wires in the mains lead of this appliance may not correspond with the coloured markings identifying the terminals in your plug proceed as follows: (See diagram).

1. Connect the green-yellow or green (Earth) wire to the terminal in the plug marked 'E' or with the symbol  or coloured green and yellow or green.
2. Connect the blue (Neutral) wire to the terminal in the plug marked 'N' or coloured black.
3. Connect the brown (Live) wire to the terminal in the plug marked 'L' or coloured red.

With alternative plugs a 13 A fuse must be fitted either in the plug or adaptor or in the main fuse box. If in doubt contact a qualified electrician.

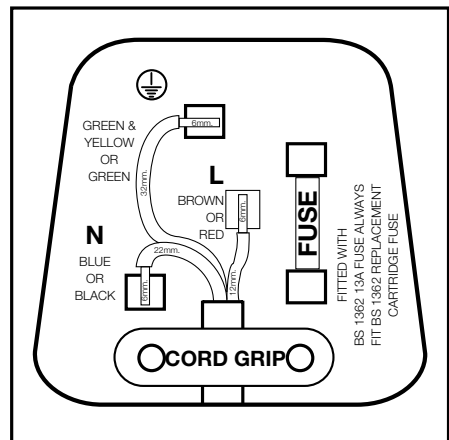

Energy Saving Tips

- 1-** Ensure your appliance is installed in a well ventilated area.
- 2-** Ensure the time between buying chilled/frozen food and placing them in your appliance is kept at minimum, particularly in summer. We recommend you use a cool bag or a special carrier bag to carry frozen food.
- 3-** Do not leave the door (s) of your appliance open longer than necessary and ensure they are closed properly after each opening.
- 4-** Defrost frozen food in the fridge compartment, so that frozen food acts as an ice pack to assist cooling in the fridge.

3 Installation

Transportation Instructions

1. The appliance should be transported only in a vertical upright position. The packing as supplied must be intact during transportation.
2. If during the course of transport the appliance has to be transported horizontally, it must only be laid on its right hand side when standing in the front of the appliance. After bringing it to upright position, it must not be operated for at least 4 hours to allow the system to settle.
3. Failure to comply with the above instructions could result in damage occurring to the appliance. The manufacturer will not be held responsible if these instructions are disregarded.
4. The appliance must be protected against rain, moisture and other atmospheric influences.
5. Empty any water in the drain tray before moving see section “Defrosting” and “Cleaning & Care” for further information

IMPORTANT : Make sure the plastic evaporating pan at the back of the product collects water properly.

“IMPORTANT: Care must be taken while cleaning / carrying the appliance to avoid touching the bottom of the condenser metal wires at the back of the appliance as you might injure your fingers and hands.

“IMPORTANT: This appliance is not designed for stacking with any other appliance. When positioning your appliance, take care not to damage your flooring, pipes, wall coverings etc.

Do not move the appliance by pulling by the door or handle. Do not attempt to sit or stand on top of your appliance as it is not designed for such use. You could injure yourself or damage the appliance.

“IMPORTANT: Make sure that mains cable is not caught under the appliance during and after carrying / moving the appliance, to avoid the mains cable becoming cut or damaged.” Do not allow children to play with the appliance or tamper with the controls.

BEKO declines to accept any liability should the instructions not be followed.

INSTALLATION INSTRUCTIONS

1. The space in the room where the appliance is installed must not be smaller than 10 cubic metres.

2. If possible avoid placing the appliance near cookers, radiators or in direct sunlight as this will cause the compressor to run for long periods. If installed next to a source of heat or refrigerator, maintain the following minimum side clearances:

From Cookers	2” (50 mm)
From Radiators	12” (300 mm)
From Refrigerators or Freezers	1” (25 mm)

3. Make sure that sufficient room is provided around the appliance to ensure free air circulation. Allow a minimum of 60 mm (2.4 inches) between the top of the appliance and the ceiling or the underside of a wall cupboard.

4. Fit the two plastic wall spacers supplied onto the condenser at the back of the appliance by rotating them 1/4 turn.

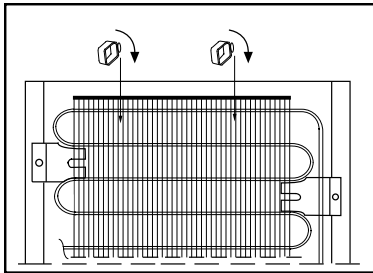

5. The appliance should be located on a smooth surface.

The two front feet can be adjusted as required.

To ensure that your appliance is standing upright adjust the two front feet by turning clockwise or anti-clockwise, until the product is in firm contact with the floor. Correct adjustment of feet avoids excessive vibration and noise.

6. Refer to “Cleaning and Care” section to prepare your appliance for use.

7. The appliance must be protected against rain, moisture and other atmospheric influences.

8. A special receptacle is supplied to store the mains plug during transit.

The receptacle is fixed at the back of the cabinet, on the right hand side of the compressor. (See diagram) Gently

remove the plug from the receptacle. Never pull the mains cord, you may damage the appliance. In the case of transportation, ensure you locate the plug in the receptacle provided to avoid transit damage. transit provided to avoid transit damage.

“IMPORTANT: Care must be taken while cleaning / carrying the appliance to avoid touching the bottom of the condenser metal wires at the back of the appliance as you might injure your fingers and hands.

“IMPORTANT: This appliance is not designed for stacking with any other appliance. When positioning your appliance, take care not to damage your flooring, pipes, wall coverings etc.

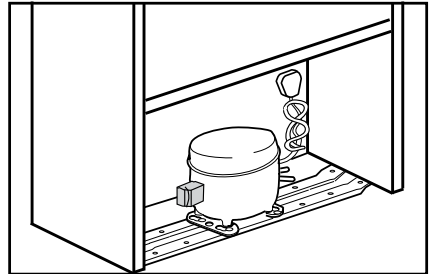

REVERSING THE DOORS

We recommend that you reverse the door before switching on for the first time.

Tools required: Small and medium size flat and cross-headed screwdrivers, a pair of pliers.

Spare Parts supplied in the plastic bag: The following parts, which are exclusively for left hand side fitted hinge operation are supplied in a plastic bag with the appliance:

- Door top trim hinge covers – there are 2 different parts, one for each side of top trim.

We suggest you keep all the parts supplied in the plastic bag and also parts, which have been removed when reversing the door, in a safe place for possible future, re-use.

IMPORTANT: We suggest you ask somebody to help you when moving the appliance around and to hold the door when removing / re-fitting hinges and the door to avoid any injury and damage to the product.

Please refer to diagrams supplied. To follow numbers in brackets below, refer to the main diagram.

1. Switch off the appliance at the socket outlet and pull out the mains plug.

2. Remove all loose items and fittings and food inside the appliance.

3. Gently prise off plastic hinge covers on both sides of front top panel using a small flat-headed screwdriver. (1-2)

4- Unscrew the bolts of the top hinge and remove top hinge. (3)

5- Remove door carefully off the bottom hinge and stand door upright in a safe place.(4)

6. Gently prise off plastic hinge cover on door top trim. Fit the other door top trim plastic off hinge cover supplied in the plastic bag.(5)

7. Gently tilt the appliance back against a strong wall on its rear side sufficiently to allow the lower hinge to be removed. Take care to protect the appliance, your wall and floor coverings. You can utilise the original packaging to do this. Once you tilt the appliance back, check to make sure the appliance is completely stable and safe before you carry on. (6)

8. Unscrew and remove the front feet and 1 bolt. (7)

9- Unscrew and remove the bottom hinge. (8)

10- Unscrew and remove the bottom hinge door stopper and bushing and reposition them on the other side while rotating the bushing 180°. (9)

11- Fit the bottom hinge and tighten the screws as shown in figure. (10)

12- Fit the other front feet as shown in figure. (11)

13- Rotate the top hinge 180°. Unscrew the hinge pin and re-tighten it to the opposite side. (12)

14- Fit the top hinge on the left hand side bushing of the door. (13)

- 15-**Locate and re-fit door to bottom hinge pin. (14)
- 16-**Re-fit the upper hinge on the opposite side by using a flat headed screwdriver. (15)
- 17.**Fit front top panel plastic hinge covers on the opposite sides. (16)
- 18.**Remove the handle cover gently taking care not to damage the appliance.(17)
- 19.**Unscrew and remove the handle (18). Do not unscrew the yellow coloured screws!
- 20.**Rotate 180 degrees and fit handle to the other side after removing hole plugs gently.(19,20)
- 21 .**Fit the handle cover.(21)
- 22-**Adjust the two front feet if necessary.
- 23-**Check that door opens and closes easily, it is aligned correctly and there are no gaps allowing air into the cabinet. If there are gaps between the door seal and the cabinet, adjust the door seal by gently pulling away from the door using fingers.
- 24-**Check that all the hinge screws are tightened. Avoid over tightening the screws.
- 25-**Put all items, fittings back in the appliance.
- 26-**Wait for at least 4 hours to allow the system to settle before switching on.
- 27-**Once the correct storage temperatures have been reached in the appliance, put back all the food.

(12)

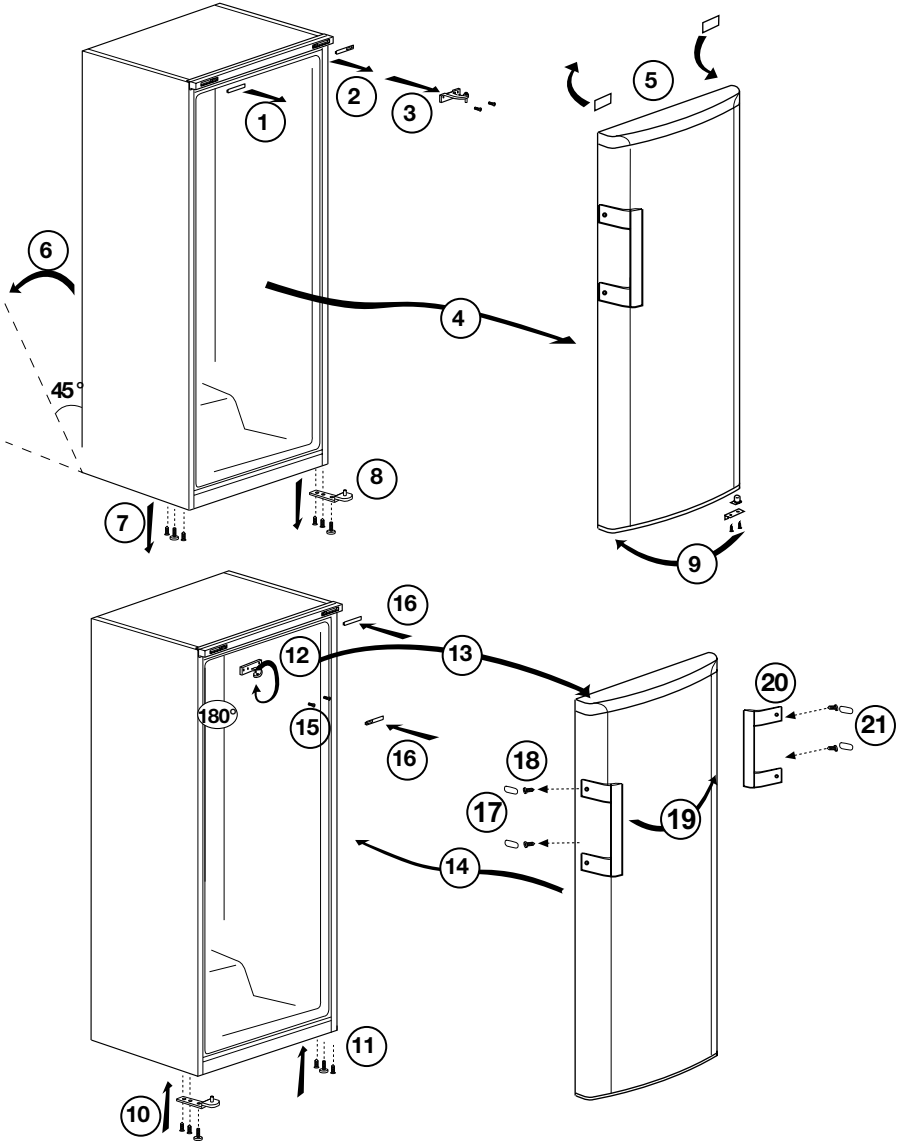
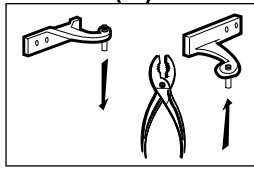

4 Before operating

STARTING

Final Check

Before you start using the refrigerator check that:

- 1.The front feet have been adjusted so the appliance is level.
- 2.The interior is dry and air can circulate freely at the rear.
- 3.Clean the interior as recommended under "CLEANING AND CARE."
- 4.Insert the plug into the wall socket and switch on the electricity supply. Avoid accidental disconnection by taping over the switch. Green light will glow and the compressor will start running in about five minutes.
- 5.You will hear a noise as the compressor starts up. The liquid and gases sealed within the refrigeration system may also give rise to noise, whether the compressor is running or not which is quite normal.
- 6.If you are going to store frozen food open the freezer door and check that the fast-freeze mode is off. (thermostat knob is not set to maximum position and the amber light is not on). When temperature reaches -18 °C or below, you can put in your frozen food. (See Storing Frozen Food).
- 7.If you are going to freeze fresh food, you must switch the thermostat knob to maximum position. The amber light will come on and you must wait at least three hours before putting in your fresh food to be frozen. (See Freezing Fresh Food)

8.Front edges of the cabinet may feel warm. This is normal. These areas are designed to be warm to avoid condensation.

9.We recommend that you set the thermostat knob at MIN setting and monitor the temperature to ensure the appliance maintains desired storage temperatures (See Temperature Control and Adjustment section).

Important Note :

- 1.If there is a power failure do not open the door. Frozen food should not be affected if the failure lasts for less than 12 hours. If the failure is longer, then the food should be checked and either eaten immediately or cooked and then re-frozen.
- 2.If you find the freezer door difficult to open just after you have closed it, don't worry. This is due to the pressure difference which will equalise and allow the door to open normally after a few moments.
- 3.You will hear a vacuum sound just after closing the door. This is quite normal.
4. When you switch on, the appliance will not start immediately, because the appliance incorporates a protection device in the electronics - wait for about 5 minutes.

5 Using your refrigerator

Setting the operating temperature

The operating temperature is regulated by the temperature control.

1 = Lowest cooling setting (Warmest setting)

MAX. = Highest cooling setting (Coldest setting)

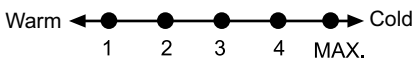

Please choose the setting according to the desired temperature.

The interior temperature also depends on ambient temperature, the frequency with which the door is opened and the amount of foods kept inside.

Frequently opening the door causes the interior temperature to rise.

For this reason, it is recommended to close the door again as soon as possible after use.

The normal storage temperature of your appliance should be $-18\text{ }^{\circ}\text{C}$ ($0\text{ }^{\circ}\text{F}$). If the thermostat knob is turned counter clockwise from position 1, the appliance will be switched off and “click” sound will be heard. Lower temperatures can be obtained by adjusting the thermostat knob towards Position 4.

This appliance is equipped with ‘Freezer Guard’ which means it can be used in unheated rooms, garages etc so if the temperature drops down as low as -15C the food will not defrost. At these low temperatures it is advised to put the thermostat to 4.

We recommend checking the temperature with a thermometer to ensure that the storage compartments are kept to the desired temperature. Remember to take the reading immediately since the thermometer temperature will rise very rapidly after you remove it from the freezer.

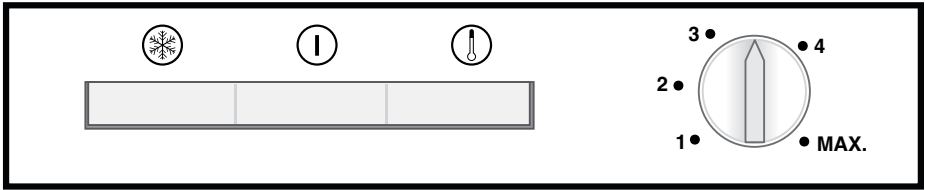

Indicator lights

There are three coloured indicator lights located inside the appliance which show the operating mode of the freezer.

Amber Indicator

Illuminates when the fast freeze switch is set to max and stays on until the fast freeze operation is deactivated. Fast-freeze operation is for freezing fresh food (see Freezing Fresh Food section).

Green Indicator

Illuminates when the appliance is connected to the mains and will glow as long as there is electricity present. The green indicator does not give any indication of the temperature inside the freezer.

Red Indicator

Illuminates

- a. If the appliance is overloaded with fresh food.
- b. If the appliance door is left open accidentally for too long

Thermostat knob

The thermostat knob is located on the indicator light frame.

Important:

When you reduce the set temperature there may be a short delay before the compressor starts to operate. This is normal and not a compressor fault.

Freezing

Freezing food

You can use the appliance for freezing fresh food as well as for storing pre-frozen food.

Please refer to the recommendations given on the packaging of your food.

• Attention

Do not freeze fizzy drinks, as the bottle may burst when the liquid in it is frozen.

Be careful with frozen products such as coloured ice-cubes.

Do not exceed the freezing capacity of your appliance in 24 hours. See the rating label.

In order to maintain the quality of the food, the freezing must be effected as rapidly as possible.

Thus, the freezing capacity will not be exceeded, and the temperature inside the freezer will not rise.

• Attention

Keep the already deep-frozen food always separated with freshly placed food.

When deep-freezing fresh food, the cooling compressor will work until the food is completely frozen.

If you find the freezer door difficult to open just after you have closed it, don't worry. This is due to the pressure difference which will equalize and allow the door to open normally after a few minutes.

You will hear a vacuum sound just after closing the door. This is quite normal.

Fast freeze

If large amounts of fresh food are going to be frozen, adjust the control knob to MAX. 24 hours before putting the fresh food in the fast freeze compartment.

It is strongly recommended to keep the knob at MAX. position at least 24 hours to freeze maximum amount of fresh food declared as freezing capacity. Take special care not to mix frozen food and fresh food.

Remember to turn the thermostat knob back to its previous position once food has frozen.

Making ice cubes

Fill the ice-cube tray 3/4 full with water and place it in the freezer.

As soon as the water has turned into

ice, you can take out the ice cubes.

Never use sharp objects such as knives or forks to remove the ice cubes. There is a risk of injury!

Let the ice cubes slightly thaw instead, or put the bottom of the tray in hot water for a short moment.

Defrosting of the appliance

The appliance defrosts automatically.

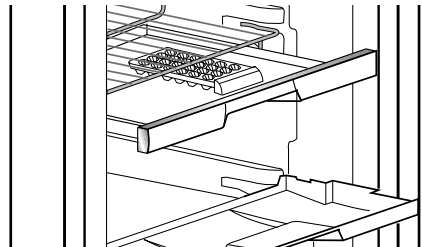

6 Maintenance and cleaning

** We recommend that you switch off the appliance at the socket outlet and pull out the mains plug before cleaning.

** Never use any sharp abrasive instrument, soap, household cleaner, detergent and wax polish for cleaning.

** Use luke warm water to clean the cabinet of the appliance and wipe it dry.

** Use a damp cloth wrung out in a solution of one teaspoon of bicarbonate of soda to one pint of water to clean the interior and wipe it dry.

** If the freezer is not going to be used for a long period of time switch it off, remove all food, clean it as above and leave the door ajar.

** To remove a drawer, pull it as far as possible, and then tilt it upwards, and then pull it out completely.

** Any dust that gathers on the condenser, which is located at the back of the freezer, should be removed once a year with a vacuum cleaner.

** Check door seals regularly to ensure they are clean and free from food particles.

7 Do's and Don'ts

Do-Check contents of the freezer at regular intervals.

Do- Clean your freezer regularly.

Do- Keep food for as short a time as possible and adhere to “Best Before”, “Use By” dates.

Do-Store commercially frozen food in accordance with the instructions given on the packets that you buy.

Do-Always choose high quality fresh food and be sure it is thoroughly clean before you freeze it.

Do-Prepare fresh food for freezing in small portions to ensure rapid freezing.

Do-Wrap all foods in aluminium foil or freezer quality polythene bags and make sure any air is excluded.

Do-Wrap frozen food when you buy it and put it in to the freezer as soon as possible.

Do-Separate food in the compartments. This will enable you to find food quickly and avoid excessive door opening therefore save electricity.

Do-Remove ice cream from the freezer 10-20 minutes before serving.

Don't- Leave the door open for long periods as this will make the freezer more costly to run.

Don't- Put hot food into the freezer. Let it cool down first.

Don't- Put liquid-filled bottles or sealed cans containing carbonated liquids into the freezer as they may burst.

Don't- Store poisonous or dangerous substances in the Freezer. Your freezer has been designed for the storage of edible foodstuffs only.

Don't- Exceed the maximum freezing capacity (20 kg in any 24 hours) when freezing fresh food.

Don't- Consume ice-cream and water ices direct from the freezer. The low temperature may cause ‘freezer burns’ on lips.

Don't- Freeze fizzy drinks.

Don't- Try to keep frozen food which has thawed, it should be eaten within 24 hours or cooked and refrozen.

Don't- Remove items from the freezer with wet hands.

Don't- Close the door before placing the fast-freeze compartment cover in its place.

Don't- Leave frozen food at room temperature to thaw; the best way to defrost food is to put it in the fridge to thaw slowly. Make sure you avoid defrosting food or food juices drip onto other food.

Don't- Remove the plastic cover on the rear wall.

Don't- Damage the pipes on the appliance.

PROBLEM SOLVING

If the appliance does not operate when switched on, check:

- The plug is inserted properly in the socket and that the power supply is on. (To check the power supply to the socket, plug in another appliance)
- The fuse has blown/circuit breaker has tripped/main distribution switch has been turned off.
- The temperature control has been set correctly.
- New plug is wired correctly if you have changed the fitted moulded plug.

If the appliance is still not operating after the above checks, please refer to the section on “How To Obtain Service”.

Please ensure that above checks have been made as a charge will be made if no fault is found.

GUARANTEE DETAILS

Your new Beko product is guaranteed against the cost of breakdown repair for twelve months from the date of the original purchase.

What is covered?

- Repairs necessary as a result of faulty materials, defective components or manufacturing defect.
- The cost of functional replacement parts, but excluding consumable items.
- The labour costs of a Beko approved repairer to carry out the repair.

What is not covered?

- Transit, delivery or accidental damage or misuse and abuse.
- Cabinet or appearance parts, including control knobs, flaps, handles or container lids.
- Accessories or consumable items including but not limited to, ice trays, scrapers, cutlery baskets, filters and light bulbs.
- Repairs required as a result of unauthorised repair or inexperienced installation that fails to meet the requirements contained in the user instruction book.
- Repairs to products used on commercial or non-residential household premises.
- Loss of frozen food in freezers or fridge/freezers. (Food loss insurance is often included within your household contents insurance policy, or may be available separately from your retailer).

Important notes.

- Your Beko product is designed and built for domestic household use only.
- The guarantee will be void if the product is installed or used in commercial or non-residential domestic household premises.
- The product must be correctly installed, located and operated in accordance with the instructions contained in the User Instructions Booklet provided.
- Professional installation by a qualified Electrical Domestic Appliance Installer is recommended for all Washing Machines, Dishwashers and Electric Cookers
- Gas Cookers must only be installed by a Gas Safe (or BORD GAIS) registered Gas Installer.
- The guarantee is given only within the boundaries of the United Kingdom and the Republic of Ireland.
- The guarantee is applicable only to new products and is not transferable if the product is resold.
- Beko disclaims any liability for incidental or consequential damages.
The guarantee does not in anyway diminish your statutory or legal rights.

HOW TO OBTAIN SERVICE

Please keep your purchase receipt or other proof of purchase in a safe place; you will need to have it should the product require attention under guarantee.

You should also complete the details below; it will help us assist you when requesting service. (The model number is printed on the Instruction Booklet and the serial number is printed on the Rating Label affixed to the appliance)

Model No: Serial No: Retailer: Date of purchase:

For service under guarantee simply telephone the appropriate number below

UK Mainland & Northern Ireland

Fridges & Freezers	0845 6004903
Electric Cookers	0845 6004902
Gas & Dual Fuel Cookers	0845 6004905
Washing Machines & Dishwashers	0845 6004906

Republic of Ireland

All Refrigeration, All Cookers Washing Machines & Dishwashers	01 862 3411
--	-------------

Before requesting service please check the trouble-shooting guide in the Operating Instructions as a charge may be levied where no fault is found even though your product may still be under guarantee.

Service once the manufacturers guarantee has expired.

If you have purchased an extended guarantee please refer to the instructions contained within the extended guarantee agreement document. Otherwise please call the appropriate number above where service can be obtained at a charge.

Should you experience any difficulty in obtaining service please contact the Beko Customer Help-Line. Tel: 0845 6004911 e-mail: service@beko.co.uk

BEKO



BEKO plc
Beko House
Caxton Way
Watford
Hertfordshire
WD18 8UF
Tel: 0845 6004911
Fax: 0845 6004922
e-mail: service@beko.co.uk
website: www.beko.co.uk

Printed in Turkey

Part no: **57 0821 0000**
Revision no: **AI**