



Washing Machine

User Manual



WTIK72121

2820532224/ EN/ / 03/05/2024 13:47



Please read this user manual first!

Dear Customer,

Thank you for choosing Beko product. We hope that you get the best results from your product which has been manufactured with high quality and state-of-the-art technology. Therefore, please read this entire user manual and all other accompanying documents carefully before using the product.

Follow all warnings and information in the user manual. Thus, you protect yourself and your product against possible dangers.

Keep the user manual. If you hand over the product to someone else, provide the user manual as well. Warranty terms, usage and troubleshooting methods of your product are in user guide.

Symbols and Definitions

The following symbols are used in the user guide:







	Danger that could result in death or injury.
	Important information or useful hints about usage.
	Read the user manual.
	Recyclable materials.
	Hot surface warning.
	
WARNING	Danger that may result in property damage to the product or its environment.

Table of Contents

1 Safety Instructions.....	4	6.8 Auxiliary Function Selection.....	28
1.1 Intended Use.....	4	6.8.1 Auxiliary Functions.....	28
1.2 Safety of Children, Vulnerable Persons and Pets	4	6.8.2 Functions/Programmes Selec- ted by Pressing the Function Keys for 3 Seconds	29
1.3 Electrical Safety.....	5	6.9 End Time	30
1.4 Handling Safety	6	6.10 Starting the Programme.....	30
1.5 Installation Safety.....	6	6.11 Loading Door Lock.....	31
1.6 Operational Safety.....	8	6.12 Changing the Selections After Programme has Started	31
1.7 Maintenance and Cleaning Safety	9	6.13 Cancelling the Programme	32
2 Important Instructions for Envir- onment.....	10	6.14 End of Programme.....	32
2.1 Compliance with WEEE Directive .	10	7 Maintenance and Cleaning.....	32
2.2 Package Information.....	10	7.1 Cleaning the Detergent Drawer	32
3 Technical Specifications.....	11	7.2 Cleaning the Loading Door and the Drum.....	33
4 Installation	12	7.3 Cleaning the Body and Control Panel.....	33
4.1 Appropriate Installation Location.	12	7.4 Cleaning the Water Intake Filters..	33
4.2 Assembly of Bottom Panel Cov- ers.....	12	7.5 Draining Remaining Water and Cleaning the Pump Filter	34
4.3 Removing Transportation Safety Bolts	13	8 Troubleshooting	34
4.4 Connecting to Water Supply	13	9 DISCLAIMER / WARNING	39
4.5 Connecting the Drain Hose to the Drain	14	10 Built-in Installation	40
4.6 Adjusting the Stands	14		
4.7 Electrical Connection	15		
4.8 Start Up	16		
5 Preliminary Preparation	16		
5.1 Sorting the Laundry	16		
5.2 Preparing Laundry for Washing....	16		
5.3 Tips for Energy and Water Saving	17		
5.4 Loading the Laundry.....	17		
5.5 Correct Load Capacity	17		
5.6 Using Detergent and Softener	17		
5.7 Tips for Efficient Washing	19		
5.8 Displayed Programme Duration ...	20		
6 Operating the Product.....	20		
6.1 Control Panel	21		
6.2 Symbols on the Display.....	22		
6.3 Programme and Consumption Table.....	23		
6.4 Programme Selection	25		
6.5 Programmes	25		
6.6 Temperature Selection.....	27		
6.7 Spin Speed Selection	27		

1 Safety Instructions

This section includes the safety instructions necessary to prevent the risk of personal injury or material damage.

Our company shall not be held responsible for damages that may occur if these instructions are not observed.

- Installation and repair operations shall always be performed by Authorised Service.
- Use original spare parts and accessories only.
- Do not repair or replace any component of the product unless it is clearly specified in the user manual.
- Do not modify the product.

1.1 Intended Use

- The product's bench life is 10 years. During this period, original spare parts will be available to operate the appliance properly.
- This product has been designed for domestic use. It is not for commercial purposes or it should not be used out of its intended use.
- The product must only be used for washing and rinsing of laundry that are marked accordingly

- This appliance is intended to be used in household and similar applications. For example;
 - Personnel kitchens of stores, offices and other work environments;
 - Ranches,
 - By customers of hotels, motels and other accommodation facilities,
 - Bed and breakfasts, hostel-like environments,
 - Common areas of apartment blocks or laundries.

1.2 Safety of Children, Vulnerable Persons and Pets

- This product may be used by children aged 8 years and older and persons with underdeveloped physical, sensory or mental capabilities or lack of experience and knowledge if they have been given supervision or instruction concerning use of the appliance in a the product safe way and the hazards involved.
- Children under the age of 3 should be kept away unless continuously supervised.
- Electrical products are dangerous for children and pets. Children or pets should not play

with, climb on top or inside the product. Check inside the product before use.

- Use child lock to prevent children from intervening with the product.
- Do not forget to close the loading door when leaving the room where the product is located. Children and pets may get locked inside and drown.
- Children should not perform cleaning and user maintenance works without an adult's supervision.
- Keep the packaging materials away from children. Risk of injury and suffocation.
- Keep all detergents and additives used for the product away from children's reach.
- Cut the power cable and break and deactivate the locking mechanism of the loading door before disposing of the product for children's safety.



1.3 Electrical Safety

- Product should be unplugged during installation, maintenance, cleaning and repair procedures. Unplug the product or turn off the fuse.
- Damaged power cables should be replaced by the authorised service in order to prevent possible danger.

- Do not tuck the power cord under the product or to the rear of the product. Do not put heavy items on the power cord. Do not over bend, crush and touch the power cable to sources of heat.
- Only use the original cable. Do not use cut or damaged cables.
- Do not use an extension cord, multi-plug or adaptor to operate your product.
- Extension cords, multi-socket outlets, adapters or portable power supplies can overheat and cause a fire. Make sure not to place power sockets and portable power supplies near or behind the product.
- The plug shall be easily accessible. If this is not possible, a mechanism that meets the electrical legislation and that disconnects all terminals from the mains (fuse, switch, main switch, etc.) shall be available on the electrical installation.
- Do not touch the plug with wet hands.
- When unplugging the appliance, don't hold the power cord, but the plug.
- Make sure the plug is not wet, dirty or dusty.

- Never connect your product to electricity saving devices. Such systems are harmful to the product.

1.4 Handling Safety

- Unplug the product before moving, remove the water outlet and water main connections. Drain any water left inside the product.
 - This product is heavy, do not handle it by yourself. It may cause injuries if your product falls on you. Do not hit and drop the product while carrying.
 - Do not hold parts such as the laundry loading door to lift and move the product. The upper tray should be tightly fixed for moving.
 - Carry the product in an upright position. If it cannot be carried upright, tilt it to the right side in frontal view.
 - Make sure that the hoses as well as the power cable are not folded, pinched or crushed after the product is fitted into its place after installation or cleaning procedures.
- product for installation and make sure the electrical mains, clean water mains and water outlet are suitable. If not, call a qualified electrician and plumber to have them make the necessary arrangements. These operations are the responsibility of the customer.
 - Prior to commencing the installation, be sure to switch off the fuse to deactivate the power supply for the line to which the product will be connected.
 - This product is intended for use at altitudes not exceeding 2000 meters above sea level.
 - Check for any damage on the product before installing it. Do not have the product installed if it is damaged.
 - Always wear personal protective equipment (gloves, etc.) during product installation, maintenance and repair. There is a risk of injury.
 - Injuries may occur if hands are put into uncovered slots. Close the holes of the transportation safety bolts with plastic plugs.
 - Do not install or leave the product at locations where it may be exposed to external environment conditions.

1.5 Installation Safety

- Check the information on the manual and installation instructions to prepare the

- Do not install the product at locations where the temperature drops below 0 °C.
- Do not place the product on a carpet or similar surface. It would create fire hazard since it cannot receive air from underneath.
- Place the product on a level and hard surface and balance with the adjustable legs.
- Connect the product to a grounding plug protected by a fuse suitable to the current values on the type label. Make sure the grounding is carried out by an expert electrician. Do not use the product without suitable grounding to local/national regulations.
- Plug the product in a socket with voltage and frequency values suitable to those indicated on the type label.
- Do not plug the product to loose, broken, dirty, greasy sockets or sockets that has come out their seats or sockets with a risk of water contact.
- Use the new hose set provided with the product. Do not re-use old hose sets. Do not make additions to the hoses.
- Connect the water inlet hose directly to the water tap. The pressure from the tap should be minimum 0.1 MPa (1 bar) and maximum 1MPa (10 bars). 10 to 80 litres of water should be running from the tap in a minute in order for the product to function properly. If the water pressure is above 1 MPa (10 Bars), a pressure-reducing valve should be fitted. The maximum allowed temperature is 25°C.
- Fit the end of the water discharge hose to the dirty water discharge drain, the sink or the bathtub.
- Place the power cable and hoses in locations without risk of tripping.
- Do not install the product behind a door, a sliding door or at another location that will prevent the door from opening completely.
- If a drier is to be placed on the product, fix with a suitable connection apparatus obtained from the authorised service.
- There is a risk of contact with electrical pieces when the upper trays is removed. Do not dismantle the upper tray of the product.
- Place the product at least 1 cm away from the edges of furniture.

1.6 Operational Safety

- When you are using the appliances, use only detergents, softeners and supplements suitable for washing machines.
- Do not use chemical solvents on the product. These materials contain an explosion risk.
- Do not operate defective or damaged products. Unplug the product (or turn off the fuse it is connected to), turn off the water tap and call an authorised service.
- Do not place sources of ignition (burning candle, cigarettes, etc.) or sources of heat (irons, furnaces, ovens, etc.) on top of or near the product. Do not put inflammable/explosive materials near the product.
- Do not get on the product.
- Unplug the product and turn off the tap if you will not be using the product for long periods.
- Detergent/maintenance materials may splash out of the detergent drawer if it is opened while the machine is working. Contact of the detergent with your skin and eyes is dangerous.
- Make sure pets do not climb inside the product. Check inside the product before use.
- Do not force open the locked loading door. The door will open once the washing is completed. If the door does not open, use the solutions for “loading door does not open” error in the Troubleshooting section.
- Do not wash elements contaminated with gasoline, kerosene, benzene, reducers, alcohol or other inflammable or explosive materials and industrial chemicals.
- Do not directly use dry cleaning detergent and do not wash, rinse or spin laundry contaminated with dry cleaning detergent.
- Do not place your hands into the rotating drum. Wait until the drum no longer rotates.
- If washing laundry at high temperatures, the discharged washing water would burn your skin if in contact with your skin, for ex. when the draining hose is connected to the tap. Do not touch the discharge water.
- Take the following precautions to prevent formation of biofilm and malodours:

- Make sure the room where the washing machine is placed is well ventilated.
- Wipe the door gasket and loading door glass with a dry and clean cloth at the end of the programme.
- The glass of the loading door will heat up when washing at high temperatures. Therefore, do not touch the loading door glass while washing, especially children.
- Before disposing of worn out and no longer usable items:
 1. Unplug the power plug and remove it from the socket.
 2. Cut the power cable and disconnect it with the plug from the appliance.
 3. Break the locking mechanism of the loading door to render it inoperable.
 4. Do not allow children to play with the outdated product.
- Do not put hands, feet and metal objects under or behind your product. This can cause jams, and any sharp edge can cause personal injury.
- Use a clean, dry cloth to wipe foreign material or dust from the plug ends. When cleaning the plug, do not use a wet or damp cloth. Otherwise, there is a risk of fire or electric shock.
- Do not wash the product with pressure washers, by spraying vapour, water or pouring water. There is a risk of electrocution.
- Do not use sharp or abrasive tools to clean the product. Do not use household cleaners, soap, detergent, gas, gasoline, thinner, alcohol, varnish, etc. while cleaning.
- Cleaning agents containing solvents might reek poisonous fumes(for ex. cleaning solvent. Do not use cleaning products containing solvents.
- There may be detergent residues in the detergent drawer when you open it for cleaning.
- Do not dismantle the filter of the discharge pump while the product is running.
- The temperature in the machine may rise up to 90°C. Clean the filter after the water



1.7 Maintenance and Cleaning Safety

- Before cleaning or servicing the washing machine, unplug it or cut the power at the fuse.
- If you need to move the product for cleaning, do not pull on the cover. The cover can break and cause injury!

in the machine cools down in order to avoid risk of getting burnt.

2 Important Instructions for Environment

2.1 Compliance with WEEE Directive



This product complies with EU WEEE Directive (2012/19/EU). This product bears a classification symbol for waste electrical and electronic equipment (WEEE).

This product has been manufactured with high quality parts and materials which can be reused and are suitable for recycling. Do not dispose of the waste product with normal domestic and other wastes at the end of its service life. Take it to the collection center for the recycling of electrical and electronic equipment. Please consult your local authorities to learn about these collection centers.

Compliance with RoHS Directive:

The product you have purchased complies with EU RoHS Directive (2011/65/EU). It does not contain harmful and prohibited materials specified in the Directive.

2.2 Package Information

Packaging materials of the product are manufactured from recyclable materials in accordance with our National Environment Regulations. Do not dispose of the packaging materials together with the domestic or other wastes. Take them to the packaging material collection points designated by the local authorities.

3 Technical Specifications

Manufacturer's name or commercial brand	Beko
Model name	WTIK72121
	7123983600
Rated Capacity (kg)	7
Maximum spin speed (cycle/min)	1200
Built-In	Yes
Height (cm)	82
Width (cm)	60
Depth (cm)	55
Single Water inlet / Double Water inlet	+ / -
Rated voltage / Rated frequency in hertz (V/Hz)	230 V / 50Hz
Rated current (A)	10
Rated power (W)	2200
Main model code	1320



The model information as stored in the product database can be reached by entering following website and searching for your model identifier (*) found on energy label.













































<https://eprel.ec.europa.eu/>

SUPPLIER'S NAME **MODEL IDENTIFIER → (*)**

A

A

Symbols Table

											
Prewash	Fast	Fast+	Extra Rinse	Extra Water	Anti Crease	Pet Hair Removal	Steam	Night Mode	Soaking	Rinse Hold	Sleeping
											
AutoDose	Liquid Detergent Selection	Softener Selection	Rinse	Spin+Drain	Drain	Temperature	Spin	No Spin	Tap Water (Cold)	No Water	Time Delay
											
Door Lock	Child Lock	On/Off	Start / Pause	Soil Level	Add Garment	Downloaded Program	Wash	Ok (End)	Cancel	AntiCrease+	Drying
											
Extra Dry	Cupboard Dry	Iron Dry	Timed Drying	Clean& Wear	Intensive	Water Mode	SaveWater				

4 Installation



Please read the "Safety Instructions" section first!



Your washing machine automatically detects the amount of laundry placed inside when selecting a program.

While installing the product, before the first use, calibration should be done to ensure that the laundry amount is detected in the most accurate way.

To do this, select the Drum Cleaning* program and cancel the spin function. Start the program without laundry. Wait for the program to finish, which will take about 15 minutes.

*The program name may vary depending on the model. For the appropriate program selection, review the program descriptions section.

- Please contact the nearest Authorised Service for the installation of the appliance.
- Make sure that the installation and electrical connections of the product are performed by authorised service agent. Manufacturer shall not be held responsible for damages caused by operations performed by unauthorised persons.
- Preparation of the location and electrical, tap water and waste water installations at the place of installation is under customer's responsibility.
- Make sure that the water inlet and discharge hoses as well as the power cable are not folded, pinched or crushed while pushing the product into its place after installation or cleaning procedures.
- Prior to installation, visually check if the product has any defects on it. Do not have the product installed if it is damaged. Damaged products cause risks for your safety.

4.1 Appropriate Installation Location

- Place the product on a hard and level floor. Do not place it onto a carpet with high pile or other similar surfaces. Placing on an improper floor shall cause noise and vibration problems.
- Total weight of the washing machine and the dryer -with full load- when they are placed on top of each other reaches to approx. 180 kilograms. Place the product on a solid and flat floor that has sufficient load carrying capacity.
- Do not place the product on the power cable.
- Do not install the product at places where temperature may fall below 0 °C. Freezing might damage your product.
- Leave a minimum space of 1 cm between the product and the furniture.
- If you will install the product on a surface with steps, never place it close to the edge.
- Do not place the product on any platform.
- Do not place heat sources such as cooker, irons, ovens, heater etc. on the appliance and do not use them on the product.

4.2 Assembly of Bottom Panel Covers



With some models, the base parts of the products are completely closed. These products do not have plugs and covers.

- In order to increase the sound comfort of the product, attach cover A after removing the package foam.

Cover A

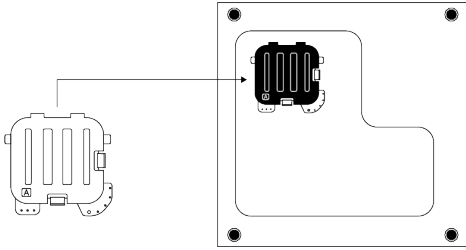

Tilt the machine back slightly. Rest the tabs of Cover A against the lower panel. Complete the assembly by rotating the cover.

- Cover B and the Cap are optional. If available, attach cover B and the Cap.

Cover B

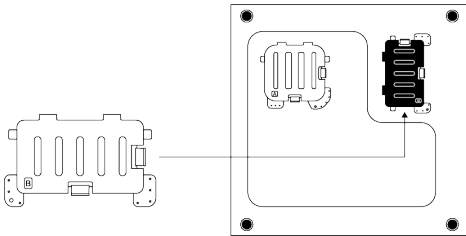

Rest the tabs of Cover B against the lower panel. Complete the assembly by rotating the cover.

Cap

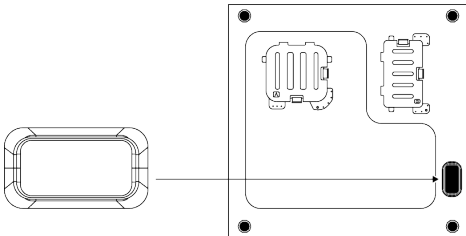

Insert the cap by pushing it with your finger.

4.3 Removing Transportation Safety Bolts

1. Loosen all transportation safety bolts with an appropriate wrench until they turn freely.
2. Bend the inner part by pressing it at the grip areas and pull the part out.

3. Attach the plastic covers supplied in the User Manual bag into the holes on the rear panel.

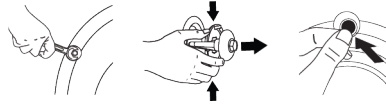

NOTICE

Remove the transportation safety bolts before operating the product. Otherwise, the product will get damaged.



NOTICE

Keep the transportation safety bolts in a safe place to reuse when the product needs to be moved again in the future. Install the transportation safety bolts in reverse order of the disassembly procedure. Never move the product without the transportation safety bolts properly fixed in place.

4.4 Connecting to Water Supply



NOTICE

Models with a single water inlet shall not be connected to the hot water tap. In such a case the laundry will get damaged or the product will switch to protection mode and will not operate. Do not use old or used water inlet hoses on a new product. It may cause water leakage from your machine and stain your laundry.

1. Tighten all hose nuts by hand. Never use a tool when tightening the nuts.
2. Open the taps completely after making the hose connection to check for water leaks at the connection points. If any leak occurs, turn off the tap and remove the nut. Check the gasket and tighten the nut carefully again. In order to pre-

vent the water leaks and resultant damages, keep the taps closed when you do not use the product.

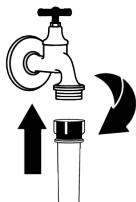
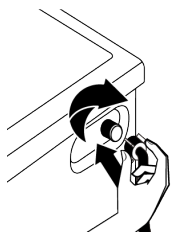

4.5 Connecting the Drain Hose to the Drain

1. Attach the end of the drain hose directly to waste water drain, washbasin or bathtub.

 Your house will be flooded if the water draining hose is dislocated during water draining. There is also a risk of burning due to the high washing temperatures. In order to prevent such situations and make sure that the product performs water intake and drain processes without any problem, fix the drain hose securely.

2. Connect the drain hose to a minimum height of 40 cm and a maximum height of 100 cm.
3. Installing the water draining hose at ground level or close to the floor (40 cm below) and then raising it makes water discharge difficult and the laundry may come out extremely wet. Thus, follow the heights provided in the figure.

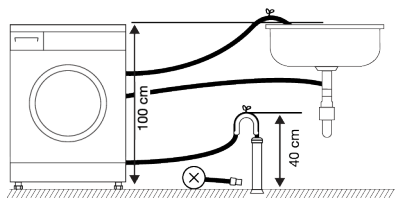

4. To prevent the waste water to go back into the product again and to ensure easy drainage, do not immerse the end

of the hose into the waste water or do not insert it into the drain for more than 15 cm. If it is too long, cut it short.

5. The end of the hose should not be bent, it should not be stepped on and the hose must not be pinched between the drain and the product. Otherwise, water discharge issues may emerge.
6. If the length of the hose is too short, use it by adding an original extension hose. The overall length of the hose shall not be longer than 3.2 m. To prevent water leaks, always secure the connection between the extension hose and the draining hose of the product with a suitable clamp so that it does not come off and cause leaks.

4.6 Adjusting the Stands

 **WARNING** In order to ensure that the product operates more silently and vibration-free, it must stand level and balanced on its feet. Ensure that the product is balanced by adjusting the feet. Otherwise, the product may move from its place and cause crushing, noise and vibration problems.

1. Loosen the nuts on the feet in the direction of the arrow with the tool in the user manual bag.
2. Adjust the feet until the product stands level and balanced. You can move the feet up by turning them counter-clockwise and down by turning them clockwise.
3. Re-tighten all lock nuts with the tool in the direction of the arrow. You can move the nuts down by turning them counter-clockwise and up by turning them clockwise.

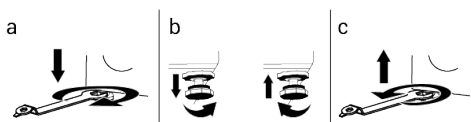

Adjustment of the Feet:

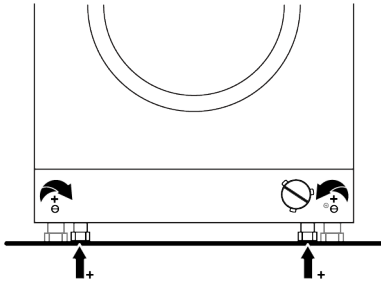

- When you turn the rotary knob shown inside the circle in the direction of the arrow, the machine will raise 0.3 mm up. If you turn it in the opposite direction of the arrow, the machine will lower by 0.3 mm.
- You can use the water meter to check the rear and front feet of the machine for the proper setting.
- Do not adjust the rear feet using rechargeable devices. Use a screwdriver instead.

Adjusting the Feet with the Water Level Indicator:

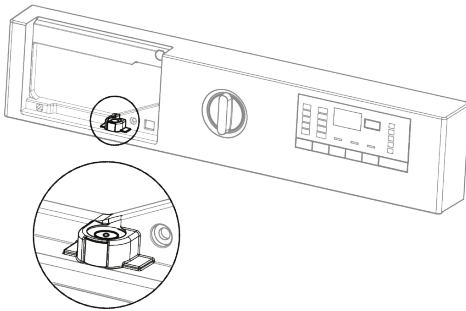

- To adjust the Water Level Indicator, you must remove the Detergent Drawer.
- The bubble inside the Water Level Indicator must be in the **middle** for the system to work correctly.
- If the bubble inside the Water Level Indicator is on the **left**, the **right** preset foot of the Washing Machine must be adjusted.
- If the bubble inside the Water Level Indicator is on the **right**, the **left** preset foot of the Washing Machine must be adjusted.

- If the bubble inside the Water Level Indicator is on the **rear**, the **front** preset foot of the Washing Machine should be turned left (clockwise).
- If the bubble inside the Water Level Indicator is on the **front**, the **front** preset foot of the Washing Machine should be turned right (counterclockwise).

4.7 Electrical Connection

Connect the product to a grounded outlet protected by a 13 A fuse. Our company shall not be responsible for the damages that shall be incurred due to using the product without grounding according to local regulations.

- Connection must comply with national regulations.
- The electrical connection cable infrastructure of the product must be adequate and suitable for product requirements. It is recommended to use a Ground Fault Circuit Breaker (GFCI).
- Power cable plug must be within easy reach after installation.
- If the current supply to the fuse or breaker in the house is less than 13 Amps, have a qualified electrician install a 13 amp supply.
- The voltage specified in the "Technical specifications" section must be equal to your mains voltage.
- Do not make connections via extension cables or multi-plugs. Overheating and burning may occur due to the connecting cable.



Damaged power cables should be replaced by the authorised service in order to prevent possible danger.

Important

Fitting a different plug:

As the colours of the wires in the mains lead of this appliance may not correspond with the coloured markings identifying the terminals on your plug, proceed as follows:

1. Connect the green - yellow or green (earth) wire to the terminal in the plug marked 'E' or with the symbol f or coloured green and yellow or green.
2. Connect the blue (neutral) wire to the terminal in the plug marked 'N' or coloured black.
3. Connect the brown (live) wire to the terminal in the plug marked 'L' or coloured red.

With the alternative plugs a 13 A fuse must be fitted either in the plug or adaptor or in the main fuse box. If in doubt contact a qualified electrician.

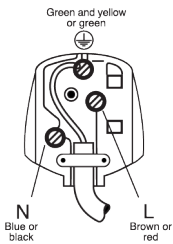

4.8 Start Up

Before starting to use the product make sure that the preparations described in section "Environmental instructions" and "Installation". To prepare the product for washing laundry, perform first operation in Drum Cleaning programme. If this programme is not available in your product, apply the method which is described in section "Cleaning the loading door and the drum".

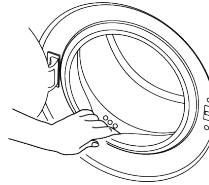

Some water has remained in the product due to the quality control processes in the production. It is not harmful for the product.

5 Preliminary Preparation



Please read the "Safety Instructions" section first!

5.1 Sorting the Laundry

- Sort laundry according to type of fabric, colour, and degree of soiling and allowable water temperature.
- Always observe the instructions given on the garment care labels.

5.2 Preparing Laundry for Washing

- Laundry items with metal attachments such as, underwiring, belt buckles or metal buttons will damage the product. Remove the metal pieces or wash such clothes by putting them in a laundry bag or pillow case.
- Take out all substances in the pockets such as coins, pens and paper clips, and turn pockets inside out and brush. Such objects may damage the product or cause noise problem.

- Put small size clothes such as infant's socks and nylon stockings in a laundry bag or pillow case.
- Place curtains in without compressing them. Remove curtain attachment items. Curtain attachment items may cause pulling and tearing on the curtain.
- Fasten zippers, sew loose buttons and mend rips and tears.
- Wash "Machine washable" or "Hand washable" labelled products only with an appropriate programme.
- Do not wash colours and whites together. New, dark coloured cottons release a lot of dye. Wash them separately.
- Tough stains must be treated properly before washing.
- Wash trousers and delicate laundry turned inside out.
- Laundry that are subjected to materials such as flour, lime dust, milk powder, etc. intensely must be shaken off before placing into the product. Such dusts and

powders on the laundry may build up on the inner parts of the product in time and can cause damage.

5.3 Tips for Energy and Water Saving

Following information will help you use the product in an ecological and energy/water-efficient manner.

- Operate the product in the highest load capacity allowed for the programme you have selected, but do not overload. See "Programme and consumption table"
- Observe the temperature instructions on the detergent packaging.
- Wash slightly soiled laundry at low temperatures.
- Use faster programmes for small quantities of lightly soiled laundry.
- Do not use prewash and high temperatures for laundry that is not heavily soiled or stained.
- If you plan to dry your laundry in a dryer, select the highest spin speed recommended during washing process.
- Do not use more detergent than the recommended amount on the detergent packaging.

5.4 Loading the Laundry

1. Open the loading door.
2. Put the laundry items into the product in a loose manner.
3. Push the loading door to close until you hear a locking sound. Ensure that no items are caught in the door. The loading door is locked while a programme is running. The door lock will open once the programme is completed. Then you can open the loading door. If the door does not open, apply the solutions provided for "Loading door cannot be opened" error in the Troubleshooting section.

5.5 Correct Load Capacity

The maximum load capacity depends on the type of laundry, the degree of soiling and the desired washing programme. The product automatically adjusts the water amount according to the weight of the laundry put inside it.



Follow the instructions in "Programme and consumption table". When the appliances is overloaded product's washing performance will drop. Moreover, noise and vibration problems may occur.

5.6 Using Detergent and Softener



WARNING

Read the manufacturer instructions on the package while using detergents, softeners, starch, bleach and decolourants, anti-lime scale and follow the dosage information provided. Use a measuring cup, if any.

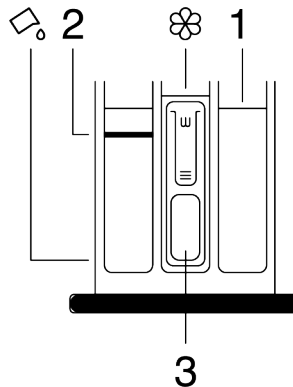

The detergent drawer comprises of three compartments:

- (1) for prewash,
 - (2) for main washing,
 - (3) for softener,
- (⊗) a syphon piece in the softener compartment,
(☞) there is a liquid detergent apparatus for liquid detergent use in the main washing compartment.

Detergent, Softener and Other Cleaning Agents

- Add detergent and softener before starting the washing programme.
- Do not leave the detergent drawer open when the washing programme is on.
- If you are using a programme without pre-washing, do not put detergent in the pre-wash compartment (compartment no. "1").
- If you are using a program with prewash, start the machine after adding powder detergent to the prewash and main wash compartments (compartments 1 and 2).
- Do not select a programme with pre-washing if you are using a detergent pod or dispensing ball. Place the detergent pod or the dispensing ball directly among the laundry in the product.
- If you are using a liquid detergent, follow the directions under "Liquid detergent use" and do not forget to bring the liquid detergent apparatus to the correct position.

Choosing the Detergent type

Detergent type to be used depends on the washing programme, fabric type and colour.

- Use different detergents for coloured and white laundry.
- Wash your delicate clothes only with special detergents (liquid detergent, wool shampoo, etc.) intended solely for delicate clothes and at suggested programmes.
- When washing dark coloured clothes and quilts, it is recommended to use liquid detergent.
- Wash woollens at suggested programme with special detergent made specifically for woollens.
- Please review the programme descriptions part for suggested programme for different textiles.
- All recommendations about detergents are valid for selectable temperature range of programmes.



Only detergents, softeners and additives suitable for washing machines should be used.
Do not use soap powder.

Adjusting the Detergent Amount

The amount of detergent depends on the amount of laundry, how soiled they are and the water hardness.

- Do not exceed the recommended dosage values on the detergent packaging in order to eliminate excessive foam and poor rinsing problems, to save money and protect the environment.
- Use less amounts of detergent for fewer or less soiled laundry.

Using Softeners

Put the softener in the softener compartment of the detergent drawer.

- Do not exceed the (>max<>) level sign in the softener compartment.
- If the softener is not fluid, dilute with water before placing in the softener compartment.



WARNING

Do not use liquid detergents or other materials with cleaning properties unless they are intended for use in washing machines for softening the laundry.

Using Liquid Detergents

If the Product Has a Liquid Detergent Apparatus

- Press and rotate the apparatus at where it is shown when you want to use liquid detergents. The part falling below will serve as a barrier for liquid detergent.
- Clean with water at its place or by removing from its place when it is necessary. Do not forget to place the apparatus in the main washing compartment (compartment no. "2") after cleaning.
- The apparatus should be up if you will use a powder detergent.

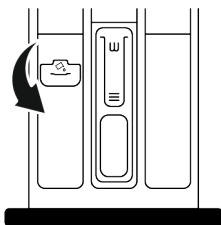

Use of Gel and Tablet Detergents

- If the detergent is fluid and there is no liquid detergent compartment in your product, place the gel detergent in the main washing detergent compartment in first water intake. If your product has a liquid detergent compartment, fill the compartment with detergent before starting the programme.
- If the gel detergent is not fluid or is in a capsule liquid tablet, place directly inside the drum before washing.
- Put the tablet detergent in the main washing compartment (compartment no. "2") or directly inside the drum before washing.

Using Starch

- Put in the liquid starch, powder starch or fabric dye in the softener compartment.
- Do not use softener and starch in the same washing programme simultaneously.
- Wipe the inside of the product with a damp and clean cloth after using starch.

Using Anti-Limescale

- When necessary, only use anti-limescale produced for washing machines.

Using Bleach and Decolourants

- Select a programme with pre-washing and add bleach at the start of pre-washing. Do not put detergent in the pre-wash compartment. As an alternative application, select a programme with additional rinsing and add the bleach while the product is receiving water to the detergent compartment in the first rinsing step.
- Do not mix and use bleach and detergent together.
- As bleach may cause skin irritation use only small amounts (1/2 tea cups - approximately 50 ml and rinse the laundry well.
- Do not pour bleach directly onto the laundry.
- Do not use bleach for coloured clothes.
- Select a programme with low temperature washing while using oxygen-based decolourants.
- Oxygen-based decolourants can be used together with detergents. However, if it does not have the same viscosity as the detergent, first place the detergent in compartment no. "2" in the detergent drawer and wait for the product to rinse away the detergent during water intake. Add the decolourant to the same compartment while the machine continues taking in water.

5.7 Tips for Efficient Washing

	Clothes			
	Light Colours and Whites	Colours	Black/Dark Colours	Delicates/Woolens/Silks
	(Recommended temperature range based on soil level: 40-90 °C)	(Recommended temperature range based on soil level: cool -40 °C)	(Recommended temperature range based on soil level: cool -40 °C)	(Recommended temperature range based on soil level: cool -30 °C)

Soiling Level	<p>Heavily Soiled (difficult stains such as grass, coffee, fruits and blood.)</p>	<p>It may be necessary to pre-treat the stains or perform prewash.</p> <p>Powder and liquid detergents recommended for whites can be used at dosages recommended for heavily soiled clothes. It is recommended to use powder detergents to clean clay and soil stains and the stains that are sensitive to bleaches.</p>	<p>Powder and liquid detergents recommended for colours can be used at dosages recommended for heavily soiled clothes. It is recommended to use powder detergents to clean clay and soil stains and the stains that are sensitive to bleaches. Detergents which do not contain decolourant should be used.</p>	<p>Liquid detergents suitable for colours and black/dark colours can be used at doses recommended for heavily soiled clothes.</p>	<p>Prefer liquid detergents produced for delicate clothes. Woollen and silk clothes must be washed with special woollen detergents.</p>
	<p>Normally Soiled (For example, stains caused by body on collars and cuffs)</p>	<p>Powder and liquid detergents recommended for whites can be used at dosages recommended for normally soiled clothes.</p>	<p>Powder and liquid detergents recommended for colours can be used at dosages recommended for normally soiled clothes. Detergents which do not contain decolourant should be used.</p>	<p>Liquid detergents suitable for colours and black/dark colours can be used at doses recommended for moderately soiled clothes.</p>	<p>Prefer liquid detergents produced for delicate clothes. Woollen and silk clothes must be washed with special woollen detergents.</p>
	<p>Lightly Soiled (No visible stains exist.)</p>	<p>Powder and liquid detergents recommended for whites can be used at dosages recommended for lightly soiled clothes.</p>	<p>Powder and liquid detergents recommended for colours can be used at dosages recommended for lightly soiled clothes. Detergents which do not contain decolourant should be used.</p>	<p>Liquid detergents suitable for colours and black/dark colours can be used at doses recommended for lightly soiled clothes.</p>	<p>Prefer liquid detergents produced for delicate clothes. Woollen and silk clothes must be washed with special woollen detergents.</p>

5.8 Displayed Programme Duration

You can view the programme duration on the display of your machine while selecting a programme. Depending on the amount of laundry you have loaded into your machine, foaming, unbalanced load conditions, fluctuations in power supply, water pressure and programme settings, the programme duration is automatically adjusted while the programme is running.

SPECIAL CASE: At programme start of Cottons and Cotton Eco programmes, display shows the duration of half load. It is the most common use case. After programme starts, in 20-25 minutes actual load is detected by the machine. And if the detected load is higher than half load; washing programme will be adjusted accordingly and programme duration increased automatically. You can follow this change on the display.

6 Operating the Product



Please read the "Safety Instructions" section first!

6.1 Control Panel

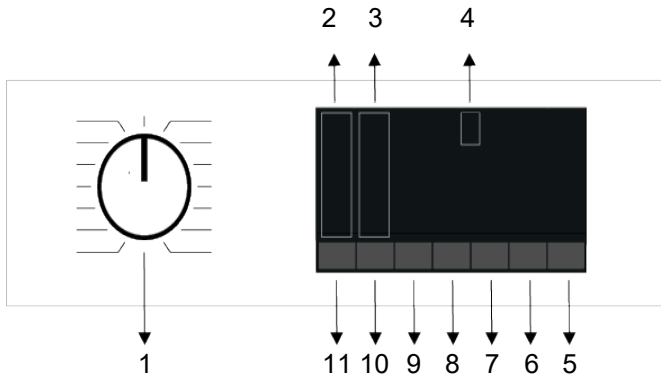

- 1 Programme Selection Button
- 3 Spin Level Indicator Lights
- 5 Start/Pause Button
- 7 Auxiliary Function Button 3
- 9 Auxiliary Function Button 1
- 11 Temperature Setting Button

- 2 Temperature Level Indicator Lights
- 4 Display
- 6 End Time Setting Button
- 8 Auxiliary Function Button 2
- 10 Spin Speed Adjustment Button

6.2 Symbols on the Display

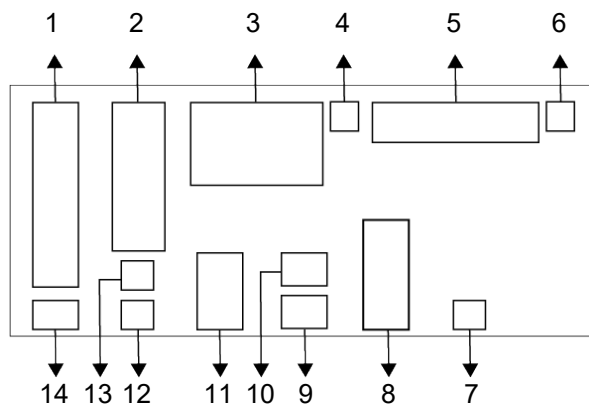

- | | |
|------------------------------------|-----------------------------------|
| 1 Temperature Indicator | 2 Spin Speed Indicator |
| 3 Duration Information | 4 Door Lock Is Engaged Symbol |
| 5 Programme Follow-up Indicator | 6 No Water Indicator |
| 7 Delayed Start Enabled Indicator | 8 Auxiliary Function Indicators 3 |
| 9 Auxiliary Function Indicators 2 | 10 Child Lock Enabled Symbol |
| 11 Auxiliary Function Indicators 1 | 12 No Spin Indicator |
| 13 Rinse Hold Indicator | 14 Cold Water Indicator |



The visuals used for machine description in this section are schematic and may not match exactly with the features of your machine.

6.3 Programme and Consumption Table

Program						Auxiliary functions					Temperature °C
	Temperature °C	Maximum load (kg)	Water consumption (lt)	Energy consumption (kWh)	Max RPM	Steam	Extra Rinse	Prewash	Water Saving	Fast/Intensive	
Cottons	90	7	95	2,30	1200	•	•	•	•	•	Cold - 90
	60	7	95	1,70	1200	•	•	•	•	•	Cold - 90
	40	7	94	0,95	1200	•	•	•	•	•	Cold - 90
	40***	7	52	0,780	1200						Cold - 90
Eco 40-60	40***	3,5	38	0,560	1200						40-60
	40***	2	29	0,355	1200						40-60
	60	3	70	1,35	1200	•	•	•	•	•	40-60
Synthetics	40	3	68	0,85	1200	•	•	•	•	•	Cold - 60
	90	7	66	2,10	1200	•	•			•	Cold - 60
Quick / Super Quick	60	7	66	1,20	1200	•	•			•	Cold - 90
	30	7	66	0,20	1200	•	•			•	Cold - 90
	30	2	40	0,15	1200	•	•			•	Cold - 90
Quick / Super Quick + Fast/Intensive	40	1,5	55	0,50	1200		•				Cold - 90
Hand Wash	20	8	95	0,39	1400	•	•	•	•	•	Cold - 40
20°C	40	3,5	85	0,90	800	•		•		•	20
Mixed Fabrics	90	-	76	2,33	600	*					Cold - 40
Drum Clean	60	3,5	82	1,55	1200			•		•	90
StainExpert	40	3	70	1,40	800	*	•	•	•	•	30-60
Shirts		4	45	0,30	1200						Cold - 60
ColdWash	90	7	125	2,80	1200	*	*				-
Anti Allergy		1	1,5	0,11	-	*					20-90
SteamTherapy	90	7	95	2,30	1200	•	•	•	•	•	-

• : Selectable.

* : Automatically selected, cannot be cancelled.

*** : Eco 40-60 programme is a test programme according to 40 ° C temperature selection, EU regulation EU / 2019/2014 and EN 60456: 2016 / A11: 2020 standard.

- : See the programme description for maximum load.



Please read Installation section of the manual before first use.

The auxiliary functions in the table may vary according to the model of your machine.

Water and energy consumption may vary subject to the changes in water pressure, water hardness and temperature, ambient temperature, type and amount of laundry, selection of auxiliary functions and spin speed, and changes in electric voltage.

Selection patterns for auxiliary functions can be changed by the manufacturer company. New selection patterns can be added or removed.

The spin speed of your machine may vary according to the programme; this spin speed cannot exceed the max. spin speed of your machine.

The amount of noise and humidity varies according to the spin speed; when the higher spin speed is selected during the spinning phase, the laundry contains less moisture but higher noise occurs at the end of the programme.



You can see the washing duration on the display of your machine while selecting a programme. Depending on the amount of laundry you have loaded into your machine, there may be a difference of 1-1.5 hours between the duration shown on the display and the actual duration of the wash cycle. Duration will be automatically updated soon after the washing starts.

Always select the lowest appropriate temperature. The most efficient programmes in terms of energy consumption are generally those that wash at low temperatures for a long time.

The spin speed information given at the program table indicates spin speed option shown on the control panel.

Consumption values (EN)

	Temperature Selection °C	Tightening Speed (rpm)	Capacity (kg)	Program duration (h:min)	Energy consumption (kWh/cycle)	Water consumption (litres/cycle)	Laundry temperature (°C)	% Of remaining humidity (%)
Eco 40-60	40	1200	7	03:27	0,780	52	40	53
	40	1200	3,5	02:41	0,560	38	38	53
	40	1200	2	02:41	0,355	29	28	55,9
Cottons	20	1200	7	03:30	0,580	94	20	53,9
	60	1200	7	03:30	1,700	95	60	53,9
Synthetics	40	1200	3	02:15	0,850	68	40	40
Quick / Super Quick	30	1200	7	00:28	0,200	66	23	62

The consumption values given for programs other than the Echo 40-60 program are indicative only.

6.4 Programme Selection

1. Determine the programme suitable for the type, quantity and soiling level of the laundry in accordance with "Programme and consumption table".



Programmes are limited with the highest spin speed appropriate for that particular type of fabric. When selecting a programme, always consider the type of fabric, colour, degree of soiling and permissible water temperature.

2. Select the desired programme with the Programme Selection knob.

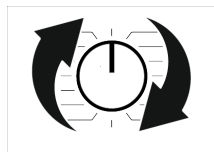

6.5 Programmes

• Eco 40-60

In the Eco 40-60 programme, you may wash normally soiled cotton laundry that are specified to be washed together at 40°C or 60°C. This programme is the standard test programme according to the EU environmentally friendly design and energy labelling regulations.

Although this programme washes longer than other washing programmes, it is more efficient in terms of energy and water consumption. Actual water temperature may be different from the stated wash temperature. When you load the machine with less laundry (e.g. ½ capacity or less), periods in programme stages may automatically get shorter. In this way, energy and water consumption would be much less.

• Cottons

You can wash your durable cotton laundry (sheets, bedlinen, towels, bathrobes, underwear etc.) in this programme. When the quick wash function button is pressed, programme duration becomes notably shorter but effective washing performance is en-

sured with intense washing movements. If the quick wash function is not selected, effective washing and rinsing performance is ensured for your heavily soiled laundry.

• Synthetics

You can wash your laundry (such as shirts, blouses, synthetic/cotton blended fabrics etc.) in this programme. When the quick wash function button is pressed, the programme duration will be shortened significantly and effective washing performance is provided for your laundry that is not very dirty. If the quick wash function is not selected, effective washing and rinsing performance is ensured for your heavily soiled laundry.

• Hand Wash

Use to wash your woollen/delicate laundry. Select the appropriate temperature complying with the tag of your clothes. Your laundry will be washed with a very gentle washing action in order not to damage the clothes.

• Anti Allergy

Applying a steam step at the beginning of the programme allows to soften the dirt easily.

Use this programme for your laundry (baby clothes, bed sheets, bedlinen, underwear, etc. cotton items) that requires an anti-allergic and hygienic washing at high temperature with intensive and long washing cycle. The high level of hygiene is ensured thanks to the steam application before the programme, long heating duration and additional rinsing step.

• Spin+Drain

You can use this program to remove the water on the garment/inside the machine.

• Rinse

Use when you want to rinse or starch separately.

• SteamTherapy

Use this programme to reduce the creases and ironing times of a small amount of unspotted cotton, synthetic or mixed laundry.



This is not a washing programme. Do not add chemicals such as detergent, bleach, stain remover, etc. to the detergent drawer during this program.

• **Shirts**

This programme is used to wash the shirts made from cotton, synthetic and synthetic blended fabrics altogether. It reduces wrinkles. Steam is applied at the end of the programme to help the wrinkle reducing function. The special spin profile and steam applied at the end of the programme reduce the wrinkles on your shirts. When the quick wash function is selected, the Pre-treatment algorithm is executed.

- Apply the pre-treatment chemical on your garments directly or add it together with the detergent in the powder detergent compartment. Thus, you can obtain the same performance as you obtain with normal washing in a much shorter period of time. Usage life of your shirts increases. Do not use pre-wash detergent if you are planning to use delay function of your machine. Prewash detergent may pour out on your clothes and cause stains.

** It is recommended to operate the cycle with no more than 6 shirts to minimize wrinkles in your shirts using this cycle. When washing more than 6 shirts, there may be differences on the wrinkle levels and humidity on shirts at the end of cycle.

• **Quick / Super Quick**

Use this programme to wash your lightly soiled or unspotted cotton clothes in a short time but not for towels or heavy cottons. The programme duration can be reduced down to 14 minutes when the quick wash function is selected. When the quick wash function is selected, maximum 2 (two) kg of laundry must be washed.

• **Drum Clean**

Regularly clean (once every 1 to 2 months) the drum for ensuring the required hygiene. Steam is applied before the programme to

soften the residues in the drum. Turn on the programme when the machine is completely empty. For better results, use powder anti-limescale (drum cleaning materials) suitable for washing machines when the powder detergent function is selected. Leave the loading door half closed after the programme ends for the inside of the machine to dry.



This is not a washing programme. This is a maintenance programme. Do not turn this programme on when there is something inside the machine. When you attempt to operate, the machine automatically senses that there is load inside, and may quit or resume the programme as per the model of your machine. An effective cleaning is not achieved if the programme is resumed.

• **Mixed Fabrics**

Use to wash your cotton and synthetic clothes together without sorting them.

• **20°C**

You can wash your lightly soiled cotton laundry in this program.

• **ColdWash**

Use to wash your medium dirty and durable cotton/synthetic laundry. Thanks to the washing algorithm specially developed for the program, effective washing is ensured without exposing the laundry to high temperatures.

• **StainExpert**

The machine has a special stain programme which enables the removal of different types of stains in the most effective way. Use this programme only for durable colourfast cotton laundry. Do not wash delicate and non-colourfast clothes and laundry in this programme. Before washing, garment tags should be checked (recommended for cotton shirts, trousers, shorts, t-shirts, baby clothes, pyjamas, aprons, table clothes, bed sheets, duvet covers, pillowcases, bath-beach towels, towels, socks,

cotton underwear that are suitable for washing at high temperature and long time).

In the automatic stain programme, you can wash 24 types of stains divided into three different groups according to quick function selection. Depending on the selected stain group, a special washing programme for which duration of rinse hold, washing action, washing and rinsing duration are modified.

Below you can find the soil groups that can be selected with the “Quick/Intense” setting button:

When “Intense” is selected;

Sweat, collar dirt, food, mayonnaise, salad dressing, make-up, machine oil, baby food.

When “Quick/Intense” is not selected;

Blood, chocolate, pudding, grass, mud, eggs, butter, curry.

When “Quick” is selected;

Tea, coffee, juice, ketchup, red wine, cola, jam, coal

1. Select the stain programme.
2. Select the stain you want to clean by locating it in the groups above and selecting the related group with the Quick/Intense auxiliary function button.
3. Read the garment tag carefully and ensure that correct temperature and spin speed are selected.

6.6 Temperature Selection

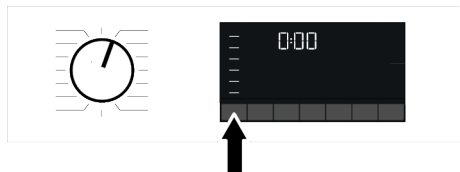

Whenever a new programme is selected, the recommended temperature for the programme appears on the temperature indicator. It is possible that the recommended temperature value is not the maximum temperature that can be selected for the current programme.

Press the Temperature Adjustment button to change the temperature. Temperature decreases gradually.

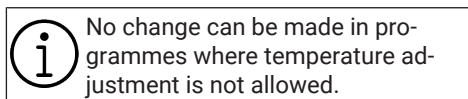

You can also change the temperature after the washing starts. This change can be made if the only washing steps allow it.

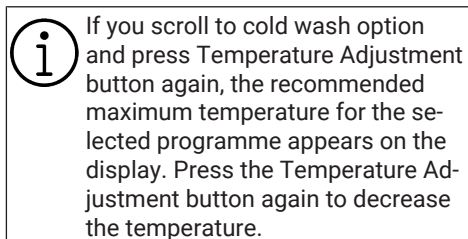

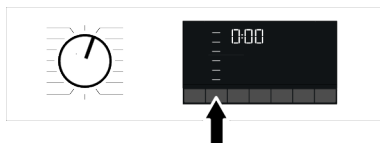

6.7 Spin Speed Selection



Whenever a new programme is selected, the recommended spin speed of the selected programme is displayed on the Spin Speed indicator. It is possible that the recommended spin speed value is not the maximum spin speed that can be selected for the current programme.

Press the Spin Speed Adjustment button to change the spin speed. Spin speed decreases gradually.

Then, depending on the model of the product, "Rinse Hold"  and "No Spin"  options appear on the display.

If you are not going to unload your laundry immediately after the programme completes, you can use Rinse Hold function in order to prevent them from getting wrinkled when there is no water in the machine.

This function holds the laundry in the final rinsing water. If you want to spin your laundry after the Rinse Hold function:

1. Adjust the Spin Speed.

2. Press Start / Pause. The programme will resume. Machine drains the water and spins the laundry.

If you want to drain the water at the end of the programme without spinning, use No Spin function.



No change can be made in programmes where spin speed adjustment is not allowed.

You can change the spin speed after the washing starts if the washing steps allow it. Changes cannot be made if the steps do not allow it.

Rinse Hold

If you are not going to unload your clothes immediately after the programme completes, you can use rinse hold function to keep your laundry in the final rinsing water in order to prevent them from getting wrinkled when there is no water in the machine. Press Start/Pause button after this process if you want to drain the water without spinning your laundry. Programme will resume and complete after draining the water.

If you want to spin the laundry held in water, adjust the Spin Speed and press Start/Pause button. The programme will resume. Water is drained, laundry is spun and the programme is completed.

6.8 Auxiliary Function Selection

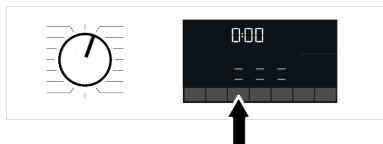

Select the desired auxiliary functions before starting the programme. Whenever a programme is selected, icons of the auxiliary function symbol that is selected together with it illuminates.



When an auxiliary function button that cannot be selected with the current programme is pressed, the washing machine will make a warning sound.

Some functions cannot be selected together. If a second auxiliary function conflicting with the first one is selected before starting the machine, the function selected first will be cancelled and the second auxiliary function selection will remain active.

An auxiliary function that is not compatible with the programme cannot be selected (See "Programme and consumption table") Some programmes have auxiliary functions that must be operated simultaneously. Those functions cannot be cancelled.

6.8.1 Auxiliary Functions

• Fast/Intensive

You can shorten or extend the programme duration with this function. Depending on the programme selection, there may be differences in time increases and decreases. In case the FAST or INTENSIVE led is not lit, the appropriate programme duration is shown for your normally soiled clothes/laundry.

Depending on the programme selection, the Intensive feature can be selected automatically. In this case, the Intensive LED on the panel will be lit. You can use the Intensive selection to achieve a better washing performance when washing heavily soiled laundry.

You can reduce the time for your lightly soiled laundry by pressing the Fast/Intensive button in the programmes which come with intense being selected. When you press the button once, the LED will turn off and you will reach the appropriate programme duration for your normally soiled clothes/laundry. When you press the same button a second time, the fast LED will light up, the time will decrease a little and it will

show the minimum programme duration, which is suitable for your less soiled laundry. The duration of programmes may shorten by 50% when this function is selected. Thanks to optimized washing steps, high mechanical agility and optimal water consumption, high washing performance is achieved despite the shorter duration.

• **Steam**

This function helps to reduce the creases of your cotton, synthetic and mixed clothes, shorten the ironing time and remove the dirt by softening.

* Under conditions where the steam function is applied at the end of the programme, your laundry may be warmer at the end of the washing. This is expected within the programme working conditions.



When you activate the steam function, do not use liquid detergent if there is no liquid container or liquid detergent dosing feature. There is the risk of staining of the clothes.

• **Water Mode**

This auxiliary function key allows you to select the additional functions of Water Saving, Pre-Wash, and Extra Rinse or Extra water depending on the model of your machine. You can find detailed information about the selection in the description of the respective auxiliary function.

• **Water Saving**

Select this function by pressing the Water Mode additional function key once for all programs indicated as selectable in the Program and Consumption table.

This function is intended for lightly soiled laundry that requires only a small amount of detergent (see "Tips for Correct Washing"). It enables environmentally friendly washing by reducing the amount of water used, without compromising on washing performance.

• **Extra Rinse**

You can use this function for all programs indicated as selectable in the Program and Consumption table. Select this function by

pressing the Water Mode key twice for programs where the additional Water Saving function can be selected, or by pressing the Water Mode key once for programs where the additional Water Saving function cannot be selected.

This function enables the product to make additional rinsing in addition to the one already made after the main wash. Thus, the risk for sensitive skins (babies, allergic skins, etc.) to be effected by the minimal detergent remnants on the laundry can be reduced.

6.8.2 Functions/Programmes Selected by Pressing the Function Keys for 3 Seconds

• **Prewash**

This function can be selected by pressing and holding the related auxiliary function button for 3 seconds.

A Prewash is only worthwhile for heavily soiled laundry. Not using the Prewash will save energy, water, detergent and time.

• **Child Lock**

Use Child Lock function to prevent children from tampering with the machine. Thus you can avoid any changes in a running programme.



You can switch on and off the machine with On / Off button when the Child Lock is active. When you switch on the machine again, programme will resume from where it has stopped.

When the Child Lock is enabled, an audio warning will be given if the buttons are pressed. Audio warning will be cancelled if the buttons are pressed five times consecutively.

To activate the child lock:

Press and hold the related auxiliary function button for 3 seconds. After the countdown as "3-2-1" on the display is over, Child

Lock symbol appears on the display. When this warning is displayed, you can release the Auxiliary Function button 3.

To deactivate the child lock:

Press and hold the related auxiliary function button for 3 seconds. After the countdown as "3-2-1" on the display is over, Child Lock symbol disappears.

6.9 End Time

Time display

When the end time function is selected, the remaining time until the programme starts is shown in hours such as 1h, 2h, and the remaining time to complete the programme after your programme starts is shown in hours and minutes as in the 01:30 example.

i Programme duration may differ from the values in section "Programme and consumption table" depending on the water pressure, water hardness and temperature, ambient temperature, amount and the type of laundry, auxiliary functions selected and the changes at the mains voltage.

After a certain period of time after the end time function is activated, the machine goes into standby mode and some LEDs on the screen turn off. If there is any user input, the LEDs will turn on again.

With the End Time function, the end time of the programme may be set up to 24 hours. After pressing End Time button, the programme's estimated ending time is displayed. If the End Time is set, End Time indicator is illuminated.

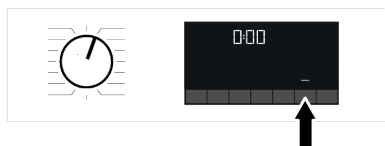

In order for the End Time function is activated and the programme is completed at the end of the specified time, you must press Start/Pause button after adjusting the time.

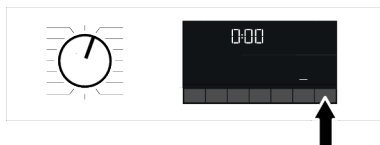

If you want to cancel End Time function, press On/Off button to turn off and on the machine.

i When you have activated the End Time function, do not add liquid detergent in the powder detergent compartment no 2. There is the risk of staining of the clothes

1. Open the loading door, place the laundry and put detergent, etc.
2. Select the washing programme, temperature, spin speed and, if required, the auxiliary functions.
3. Set the End Time of your choice by pressing the End Time button. End Time indicator lights.
4. Press Start / Pause. Time countdown starts.

i Additional laundry can be added into the machine during the End Time countdown. At the end of the countdown, End Time indicator turns off, washing cycle starts and the time of the selected programme appears on the display.

6.10 Starting the Programme

1. Press Start / Pause button to start the programme.

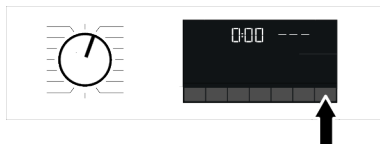

2. The Start / Pause button's light which was off before starts to illuminate steadily now, indicating that the programme has started.
3. Loading door is locked. The door lock symbol appears on the display after the loading door is locked.
4. Programme follow-up indicator lights on the display will show the current programme step.

6.11 Loading Door Lock

There is a locking system on the loading door of the machine that prevents opening of the loading door in cases when the water level is unsuitable.

"Door Locked" symbol appears on the display when the loading door is locked.



Opening the loading door in case of power failure:



In case of a power failure, you can use the loading door emergency handle to manually open the loading door.



Before opening the loading door, make sure that there is no water in the machine to avoid flooding.

1. Turn off and unplug the appliance.
2. Use a screwdriver to remove the loading door emergency handle screw located under the front wall.

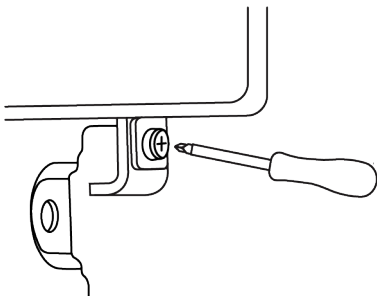

3. Open the loading door by pulling the loading door emergency handle downwards.

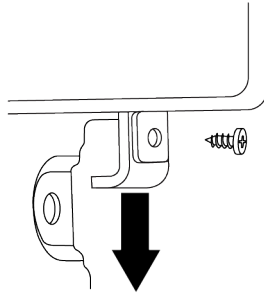

4. Try to pull the handle downwards again if the loading door is not opened.

6.12 Changing the Selections After Programme has Started

Adding laundry after the programme has started:

If the water level in the machine is suitable when you press Start/Pause button, the door lock will be deactivated and the door will open, allowing you to add garments. The door lock icon on the display goes off when the door lock is deactivated. After adding garments, close the door and press Start/Pause button once again to resume the washing cycle.

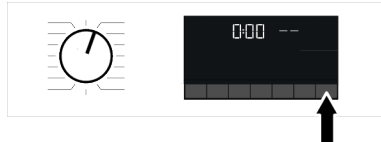

If the water level in the machine is not suitable when you press Start/Pause button, the door lock cannot be deactivated and the door lock icon on the display remains on.



If the temperature of the water inside the machine is above 50°C, you cannot deactivate the door lock for safety reasons, even if the water level is suitable.

Switching the machine to pause mode:

Press the Start/Pause button to switch the machine to pause mode. Pause symbol will flash on the display.

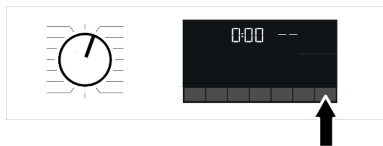

Changing the programme selection after programme has started:

The programme change is allowed when the current programme is running unless the Child Lock is enabled. This action will cancel the current programme.



The selected programme starts anew.

Changing the auxiliary function, speed and temperature:

Depending on the step the programme has reached, you can cancel or activate the auxiliary functions. See "Auxiliary function selection"

You can also change the speed and temperature settings. See "Spin speed selection" and "Temperature selection".



The loading door will not open if the water temperature in the machine is high or the water level is above the loading door baseline.

7 Maintenance and Cleaning



Please read the "Safety Instructions" section first!

Service life of your product extends and frequently experienced problems will be reduced if it is cleaned at regular intervals.

7.1 Cleaning the Detergent Drawer

Clean the detergent drawer at regular intervals (once every 4 to 5 wash) as mentioned below to prevent accumulation of powder detergent.

6.13 Cancelling the Programme

The programme is cancelled when programme selection knob is turned to a different programme or machine is turned off and on again using the programme selection knob.



If you turn the programme selection knob when the Child Lock is enabled, the programme will not be cancelled. You should cancel the Child Lock first.

If you want to open the loading door after you have cancelled the programme but if it is not possible to open the loading door since the water level in the machine is above the loading door baseline, then turn the Programme Selection knob to Pump+Spin programme and drain the water in the machine.

6.14 End of Programme

End symbol appears on the display when the programme is completed.

If you do not press any button for 10 minutes, the machine will switch to OFF mode. Display and all indicators are turned off.

Completed programme steps will be displayed if you press On/Off button.

Clean the syphon if excess amounts of water and fabric softener mixture remains in the softener compartment.

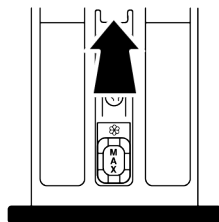

1. Press the marked part of the syphon within the softener compartment and then pull the drawer towards yourself to take it out.
2. Lift and remove the syphon from behind as shown.
3. Rinse drawer and syphon in the sink with plenty of warm water. Use gloves or suitable brush to prevent contact of residues in the drawer with your skin.
4. Firmly fit the syphon and the drawer back after cleaning.

7.2 Cleaning the Loading Door and the Drum

For products with drum cleaning programme, please see the Operating the product section.

 Repeat Drum Cleaning process in every 2 months.
NOTICE: Use an anti-limescale suitable for the washing machines.

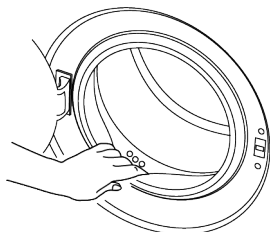

After every washing make sure that no foreign substance is left in the product. If the holes on the door gasket shown in the figure is blocked, open the holes using a toothpick.

Foreign metal substances will cause rust stains in the drum. Clean the stains on the drum surface by using cleaning agents for stainless steel.

Never use steel wool or wire wool. These will damage the painted, chrome coated and plastic surfaces.

We recommend you to wipe the door gasket with a dry and clean cloth at the end of the programme. This will remove residues on the door gasket in your machine and prevent formation of malodours.

7.3 Cleaning the Body and Control Panel

Wipe the body of the product with soapy water or non-corrosive mild gel detergents as necessary, and dry with a soft cloth. Use only a soft and damp cloth to clean the control panel. Do not use cleaning products that contain bleach

7.4 Cleaning the Water Intake Filters

There is a filter at the end of each water intake valve at the rear of the product and also at the end of each water intake hose where they are connected to the tap. These filters prevent foreign substances and dirt in the water to enter the product. Filters should be cleaned if they are dirty.

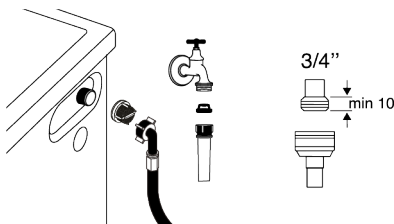

1. Close the taps.
2. Remove the nuts of the water intake hoses to access the filters on the water intake valves and clean them with an appropriate brush. If the filters are too dirty, remove them from their places with a pliers and clean in this way.
3. Take out the filters on the flat ends of the water intake hoses together with the gaskets and clean thoroughly under running water.
4. Replace the gaskets and filters carefully and tighten their nuts by hand.

7.5 Draining Remaining Water and Cleaning the Pump Filter

The filter system in your product prevents solid items such as buttons, coins and fabric fibres clogging the pump impeller during draining of washing water. Thus, the water will be drained without any problem and the service life of the pump will extend.

If the product fails to drain water inside it, the pump filter is clogged. Filter must be cleaned whenever it is clogged or in every 3 months. Water must be drained off first to clean the pump filter.

In addition, prior to transporting the product (e.g., when moving to another house) water should be drained completely.



NOTE:

Foreign substances left in the pump filter may damage your product or may cause noise problem.

If you live in areas prone to frost, remember to turn off the water tap, disconnect the main hose, and drain the water from the product when it's not in use.

After each use, turn off the tap to which the mains hose is connected.

In order to clean the dirty filter and drain the water:

- Unplug the product to cut off the supply power.



Temperature of the water inside the product may rise up to 90 °C. To avoid the risk of scalding, clean the filter after the water inside the product is cooled down.

- Follow the below procedures in order to drain water.

If the product has an emergency water draining hose, in order to drain the water:

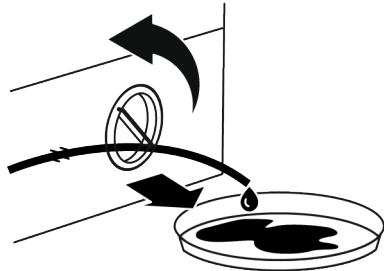

- Pull the emergency draining hose out of its seat.
- Place the end of the hose in a large container. Drain the water into the container by pulling out the plug at the end of the hose. When the container is full, close the mouth of the hose by inserting the stopper. After the container is emptied, repeat the above procedure to drain the water in the product completely.
- When the water drain is finished, close the end with the plug again and fix the hose in its place.
- Unscrew the pump filter.
- Clean any residues inside the filter as well as fibres, if any, around the pump impeller region.
- Replace the filter.

8 Troubleshooting



Please read the "Safety Instructions" section first!

Programmes do not start after the loading door is closed.

- Start / Pause / Cancel button is not pressed. >>> Press Start / Pause / Cancel button.

- It may be difficult to close the loading door in case of excessive loading. >>> Reduce the amount of laundry and make sure that the loading door is closed properly.

Programme cannot be started or selected.

- The product has switched to self-protection mode due to a supply problem (line voltage, water pressure, etc.). >>> Depending on the product model, select another program by turning the Program Selection button or pressing and holding the On/Off button for 3 seconds to cancel the program. Previous programme will be cancelled. See Cancelling the Programme [► 32]

Water inside the product.

- Some water has remained in the product due to the quality control processes in the production. >>> This is not a failure; water is not harmful to the product.

The product does not take water in.

- Tap is turned off. >>> Turn on the taps.
- Water inlet hose is bent. >>> Flatten the hose.
- Water inlet filter is clogged. >>> Clean the filter.
- Loading door is not closed. >>> Close the door.

The product does not drain water.

- Water drain hose is clogged or twisted. >>> Clean or flatten the hose.
- Pump filter is clogged. >>> Clean the pump filter.

Product vibrates or makes noise.

- Product is standing unbalanced. >>> Adjust the stands to balance the product.
- A hard substance has entered into the pump filter. >>> Clean the pump filter.
- Transportation safety bolts are not removed. >>> Remove the transportation safety bolts.
- Laundry quantity in the product is too little. >>> Add more laundry to the product.
- Excessive laundry is loaded in the product. >>> Take out some of the laundry from the product or distribute the load by hand to balance it homogeneously in the product.

- Product is leaning on a rigid item. >>> Make sure that the product is not leaning on anything.

There is water leaking from the bottom of the product.

- Water drain hose is clogged or twisted. >>> Clean or flatten the hose.
- Pump filter is clogged. >>> Clean the pump filter.

Product stopped shortly after the programme started.

- Machine has stopped temporarily due to low voltage. >>> Product will resume running when the voltage restores to the normal level.

Product directly drains the water it takes in.

- Draining hose is not at adequate height. >>> Connect the water draining hose as described in the user manual.

No water can be seen in the product during washing.

- Water is inside the invisible part of the product. >>> This is not a failure.

Loading door cannot be opened.

- Loading door lock is activated because of the water level in the product. >>> Drain the water by running the Pump or Spin programme.
- Product is heating up the water or it is at the spinning cycle. >>> Wait until the programme completes.
- Loading door may be stuck because of the pressure it is subjected to. >>> Grab the handle and push and pull the loading door to release and open it.
- If there is no power, loading door of the product will not open. >>> To open the loading door, open the pump filter cap and pull down the emergency handle positioned at the rear side of the said cap. See Loading Door Lock [► 31]

Washing takes longer than specified in the user manual. (*)

- Water pressure is low. >>> Product waits until taking in adequate amount of water to prevent poor washing quality due to the decreased amount of water. Therefore, the washing time extends.
- Voltage is low. >>> Washing time is prolonged to avoid poor washing results when the supply voltage is low.
- Input temperature of water is low. >>> Required time to heat up the water extends in cold seasons. Also, washing time can be lengthened to avoid poor washing results.
- Number of rinses and/or amount of rinsing water have increased. >>> Product increases the amount of rinsing water when good rinsing is needed and adds an extra rinsing step if necessary.
- Excessive foam has occurred and automatic foam absorption system has been activated due to too much detergent usage. >>> Use recommended amount of detergent.

Programme duration does not count-down. (On models with display) (*)

- Timer may stop during water intake. >>> Timer indicator will not countdown until the product takes in adequate amount of water. The product will wait until there is sufficient amount of water to avoid poor washing results due to lack of water. Timer indicator will resume countdown after this.
- Timer may stop during heating step. >>> Timer indicator will not countdown until the product reaches the selected temperature.
- Timer may stop during spinning step. >>> Automatic unbalanced load detection system is activated due to the unbalanced distribution of the laundry in the product.

Programme duration does not count-down. (*)

- There is unbalanced load in the product. >>> Automatic unbalanced load detection system is activated due to the unbalanced distribution of the laundry in the product.

Product does not switch to spinning step. (*)

- There is unbalanced load in the product. >>> Automatic unbalanced load detection system is activated due to the unbalanced distribution of the laundry in the product.
- The product will not spin if water is not drained completely. >>> Check the filter and the draining hose.
- Excessive foam has occurred and automatic foam absorption system has been activated due to too much detergent usage. >>> Use recommended amount of detergent.

Washing performance is poor: Laundry turns gray. ()**

- Insufficient amount of detergent has been used over a long period of time. >>> Use the recommended amount of detergent appropriate for water hardness and the laundry.
- Washing has been made at low temperatures for a long time. >>> Select the proper temperature for the laundry to be washed.
- Insufficient amount of detergent is used with hard water. >>> Using insufficient amount of detergent with hard water causes the soil to stick on the cloth and this turns the cloth into gray in time. It is difficult to eliminate graying once it happens. Use the recommended amount of detergent appropriate for water hardness and the laundry.
- Excessive amount of detergent is used. >>> Use the recommended amount of detergent appropriate for water hardness and the laundry.

Washing performance is poor: Stains persist or the laundry is not whitened. ()**

- Insufficient amount of detergent is used. >>> Use the recommended amount of detergent appropriate for water hardness and the laundry.
- Excessive laundry is loaded in. >>> Do not load the product in excess. Load with amounts recommended in the "Programme and consumption table".
- Wrong programme and temperature were selected. >>> Select the proper programme and temperature for the laundry to be washed.
- Wrong type of detergent is used. >>> Use original detergent appropriate for the product.
- Excessive amount of detergent is used. >>> Put the detergent in the correct compartment. Do not mix the bleaching agent and the detergent with each other.

Washing performance is poor: Oily stains appeared on the laundry. ()**

- Regular drum cleaning is not applied. >>> Clean the drum regularly. For this procedure, see Cleaning the Loading Door and the Drum [► 33]

Washing performance is poor: Clothes smell unpleasantly. ()**

- Odours and bacteria layers are formed on the drum as a result of continuous washing at lower temperatures and/or in short programmes. >>> Leave the detergent drawer as well as the loading door of the product ajar after each washing. Thus, a humid environment favourable for bacteria cannot occur in the machine

Colour of the clothes faded. ()**

- Excessive laundry was loaded in. >>> Do not load the product in excess.
- Detergent in use is damp. >>> Keep detergents closed in an environment free of humidity and do not expose them to excessive temperatures.

- A higher temperature was selected. >>> Select the proper programme and temperature according to the type and soiling degree of the laundry.

Washing machine does not rinse well.

- The amount, brand and storage conditions of the detergent used are inappropriate. >>> Use a detergent appropriate for the washing machine and your laundry. Keep detergents closed in an environment free of humidity and do not expose them to excessive temperatures.
- Detergent was put in the wrong compartment. >>> If detergent is put in the prewash compartment although prewash cycle is not selected, the product can take this detergent during rinsing or softener step. Put the detergent in the correct compartment.
- Pump filter is clogged. >>> Check the filter.
- Draining hose is folded. >>> Check the drain hose.

Laundry became stiff after washing. ()**

- Insufficient amount of detergent is used. >>> Using insufficient amount of detergent for the water hardness can cause the laundry to become stiff in time. Use appropriate amount of detergent according to the water hardness.
- Detergent was put in the wrong compartment. >>> If detergent is put in the prewash compartment although prewash cycle is not selected, the product can take this detergent during rinsing or softener step. Put the detergent in the correct compartment.
- Detergent was mixed with the softener. >>> Do not mix the softener with detergent. Wash and clean the drawer with hot water.

Laundry does not smell like the softener. ()**

- Detergent was put in the wrong compartment. >>> If detergent is put in the prewash compartment although prewash cycle is not selected product, the can take this detergent during rinsing or

softener step. Wash and clean the drawer with hot water. Put the detergent in the correct compartment.

- Detergent was mixed with the softener. >>> Do not mix the softener with detergent. Wash and clean the drawer with hot water.

Detergent residue in the detergent drawer. ()**

- Detergent was put in wet drawer. >>> Dry the detergent drawer before putting in detergent.
- Detergent has gotten damp. >>> Keep detergents closed in an environment free of humidity and do not expose them to excessive temperatures.
- Water pressure is low. >>> Check the water pressure.
- The detergent in the main wash compartment got wet while taking in the prewash water. Holes of the detergent compartment are blocked. >>> Check the holes and clean if they are clogged.
- There is a problem with the detergent drawer valves. >>> Call the Authorised Service Agent.
- Detergent was mixed with the softener. >>> Do not mix the softener with detergent. Wash and clean the drawer with hot water.
- Regular drum cleaning is not applied. >>> Clean the drum regularly. For this procedure, see Cleaning the Loading Door and the Drum [► 33]

Too much foam forms inside the product. ()**

- Improper detergents for the washing machine is used. >>> Use detergents appropriate for the washing machine.
- Excessive amount of detergent is used. >>> Use only sufficient amount of detergent.
- Detergent was stored under improper conditions. >>> Store detergent in a closed and dry location. Do not store in excessively hot places.

- Some meshed laundry such as tulle may foam too much because of their texture. >>> Use smaller amounts of detergent for this type of item.
- Detergent was put in the wrong compartment. >>> Make sure you place the detergent in the appropriate compartment.
- Softener is being taken early by the product. >>> There may be problem in the valves or in the detergent drawer. Call the Authorised Service Agent.

Foam is overflowing from the detergent drawer.

- Too much detergent is used. >>> Mix 1 tablespoonful softener and ½ l water and pour into the main wash compartment of the detergent drawer. >>> Put detergent into the product suitable for the programmes and maximum loads indicated in the "Programme and consumption table". When you use additional chemicals (stain removers, bleaches and etc.), reduce the amount of detergent.

Laundry remains wet at the end of the programme. (*)

- Excessive foam has occurred and automatic foam absorption system has been activated due to too much detergent usage. >>> Use recommended amount of detergent.

(*) The product does not switch to spinning step when the laundry is not evenly distributed in the drum to prevent any damage to the product and to its surrounding environment. Laundry should be rearranged and respun.

(**) Regular drum cleaning is not applied. Clean the drum regularly. See Cleaning the Loading Door and the Drum [► 33]



If you cannot eliminate the problem although you follow the instructions in this section, consult your dealer or the Authorised Service Agent. Never try to repair a nonfunctional product yourself.

9 DISCLAIMER / WARNING

Some (simple) failures can be adequately handled by the end-user without any safety issue or unsafe use arising, provided that they are carried out within the limits and in accordance with the following instructions (see the "Self-Repair" section).

Therefore, unless otherwise authorized in the "Self-Repair" section below, repairs shall be addressed to registered professional repairers in order to avoid safety issues. A registered professional repairer is a professional repairer that has been granted access to the instructions and spare parts list of this product by the manufacturer according to the methods described in legislative acts pursuant to Directive 2009/125/EC.

However, only the service agent (i.e. authorized professional repairers) that you can reach through the phone number given in the user manual/warranty card or through your authorized dealer may provide service under the guarantee terms. Therefore, please be advised that repairs by professional repairers (who are not authorized by Beko) shall void the guarantee.

Self-Repair

Self-repair can be done by the end-user with regard to the following spare parts: door, door hinge and seals, other seals, door locking assembly and plastic peripherals such as detergent dispensers (an updated list is also available in support.beko.com as of 1st of March 2021) Moreover, to ensure product safety and to prevent risk of serious injury, the mentioned self-repair shall be done following the instructions in the user manual for self-repair or which are available in support.beko.com For your safety, unplug the product before attempting any self-repair.

Repair and repair attempts by end-users for parts not included in such list and/or not following the instructions in the user manuals for self-repair or which are available in

support.beko.com , might give raise to safety issues not attributable to support.beko.com , and will void the warranty of the product.

Therefore, it is highly recommended that end-users refrain from the attempt to carry out repairs falling outside the mentioned list of spare parts, contacting in such cases authorized professional repairers or registered professional repairers. On the contrary, such attempts by end-users may cause safety issues and damage the product and subsequently cause fire, flood, electrocution and serious personal injury to occur.

By way of example, but not limited to, the following repairs must be addressed to authorized professional repairers or registered professional repairers: motor, pump assembly, main board, motor board, display board, heaters etc.

The manufacturer/seller cannot be held liable in any case where end-users do not comply with the above

The spare part availability of the washing machine or washer-dryer that you purchased is 10 years. During this period, original spare parts will be available to operate the washing machine or washer-dryer properly.

10 Built-in Installation

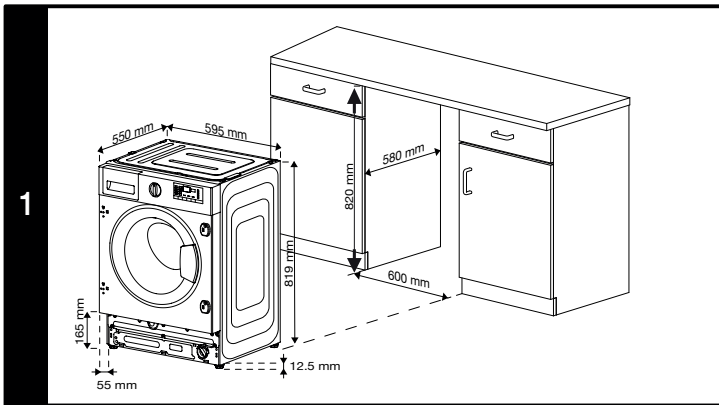
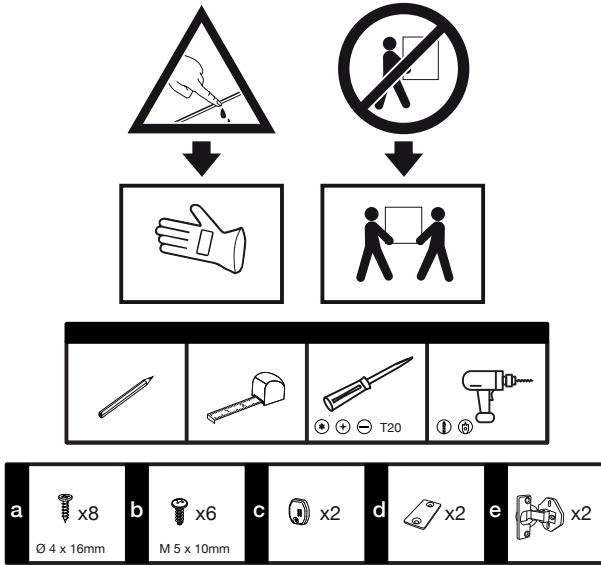

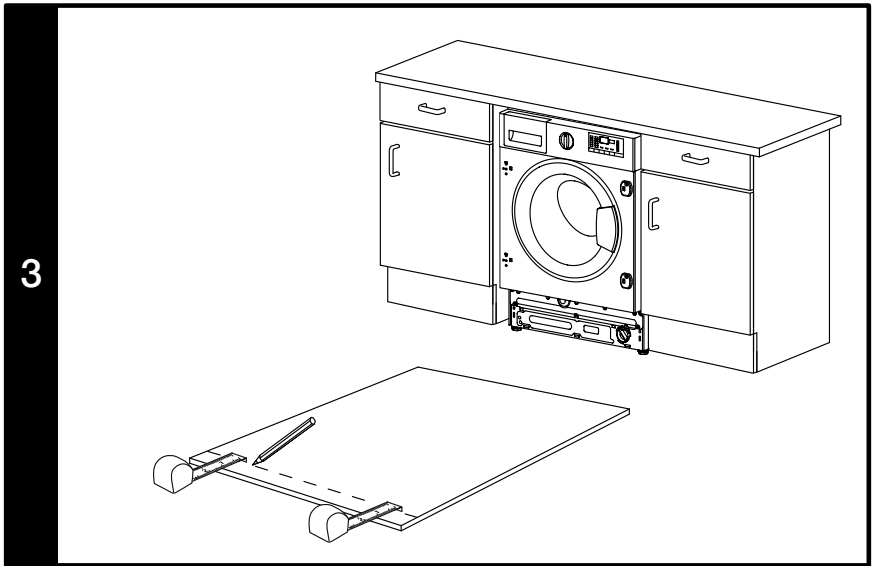
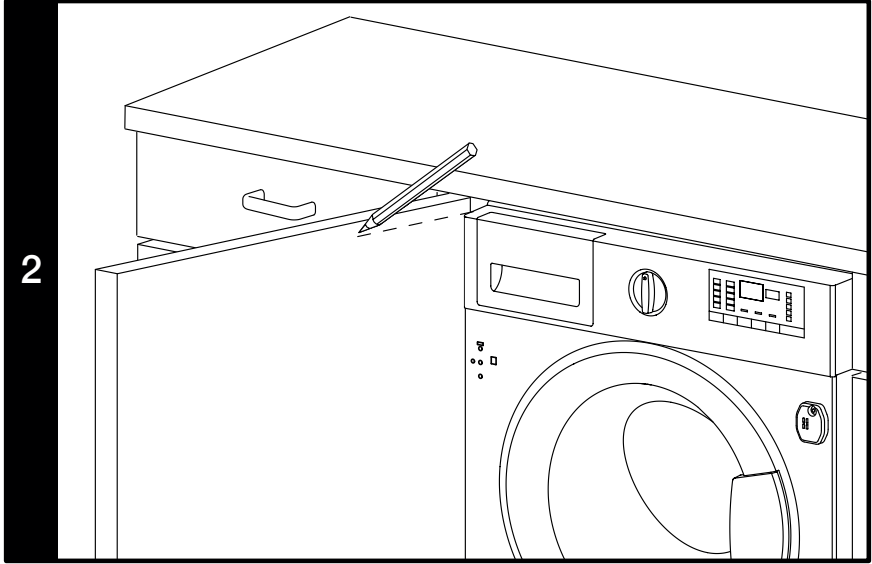

L

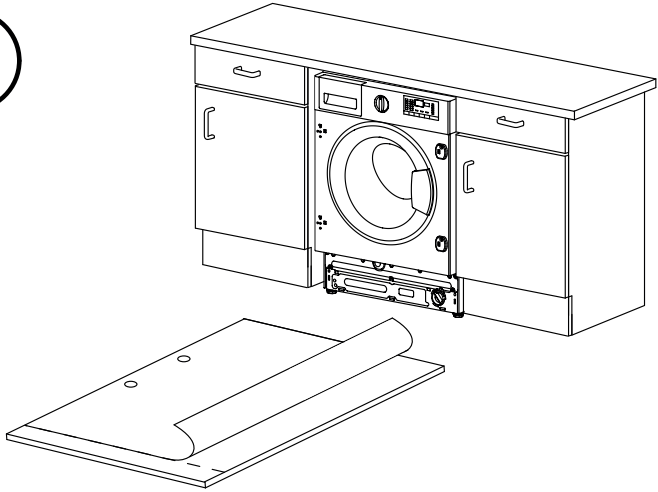

4

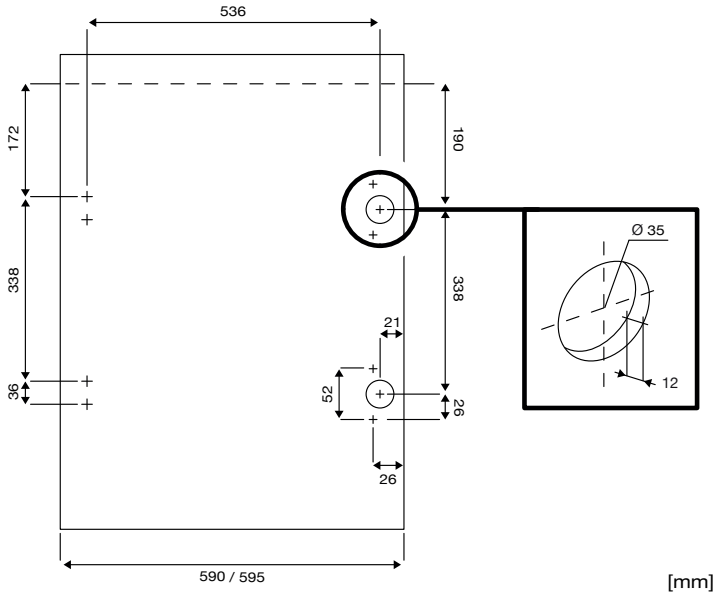

[mm]

R

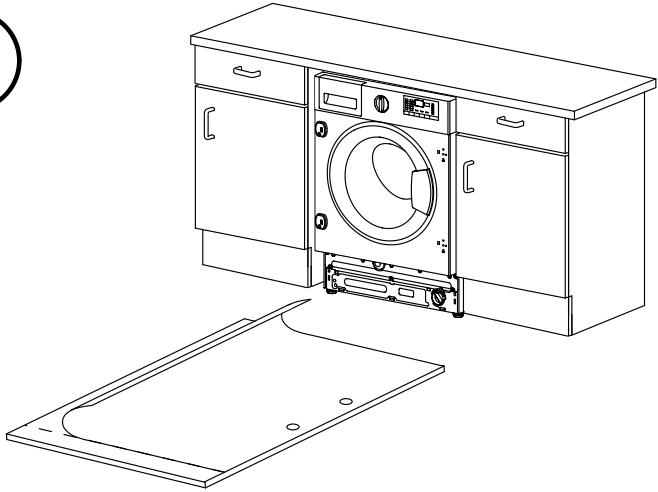

4

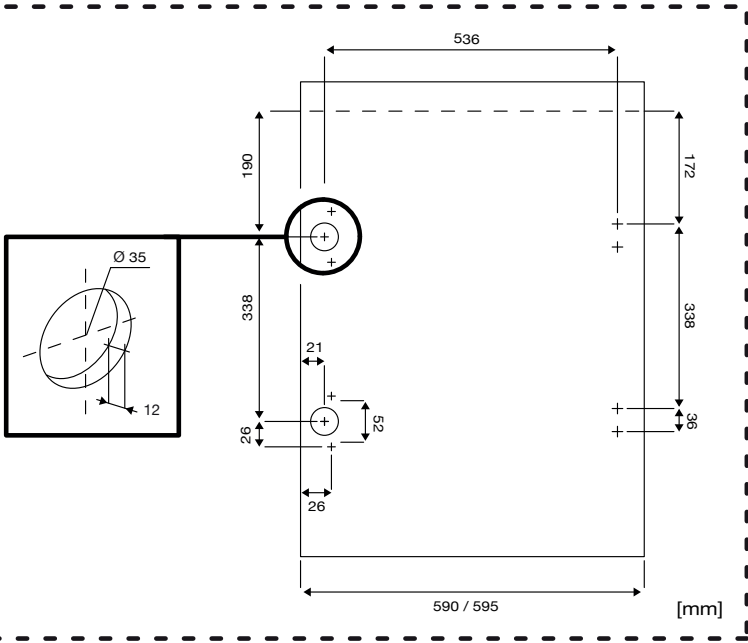

5

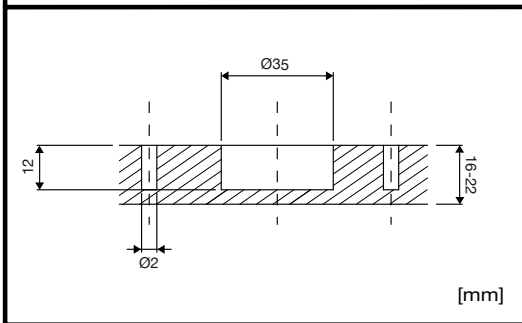
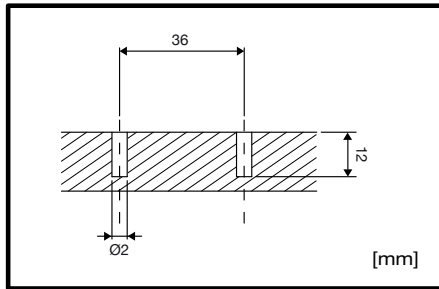
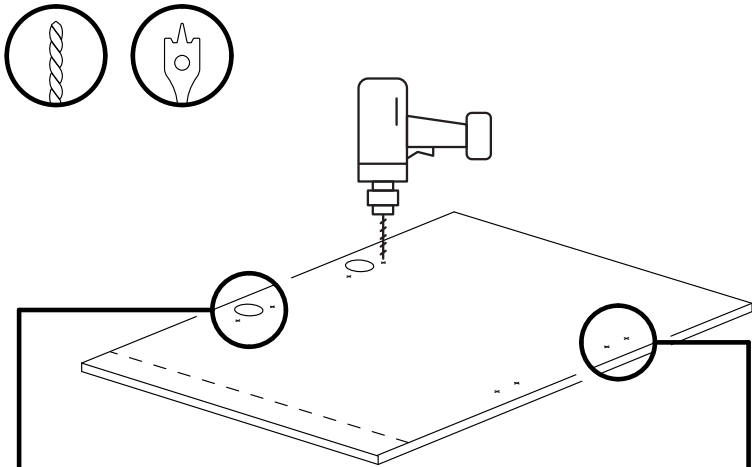

6

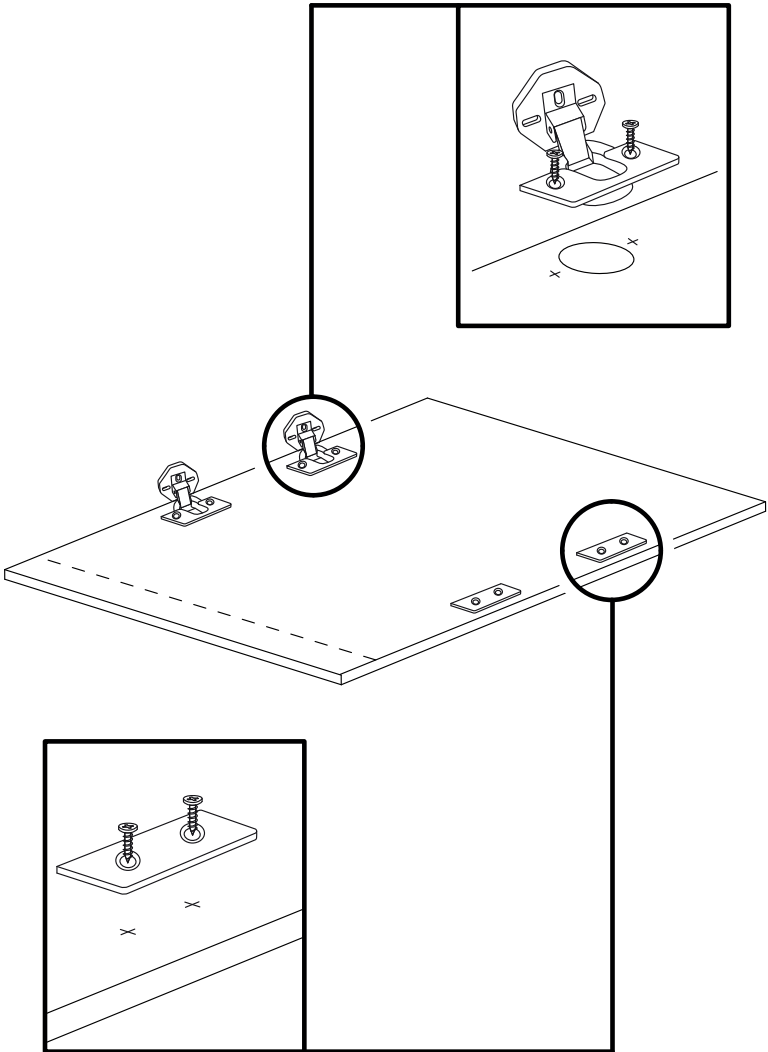

7

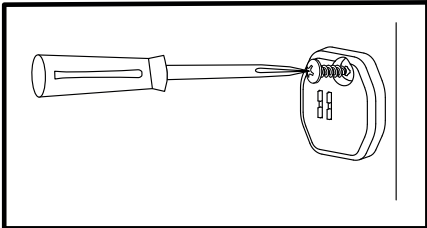
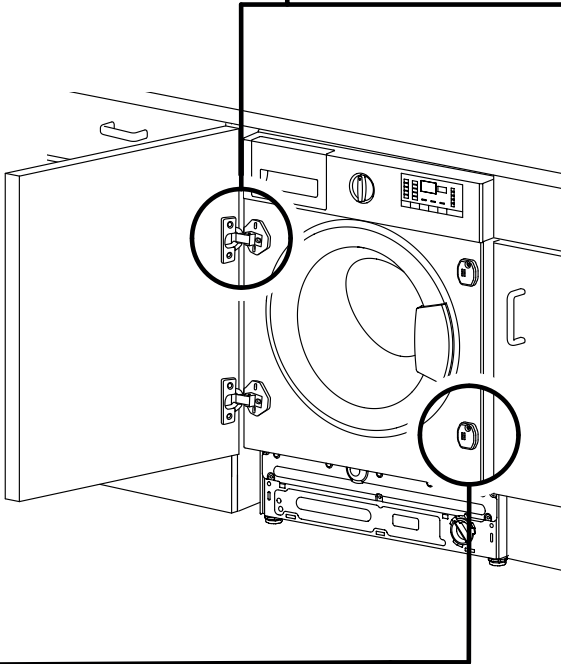
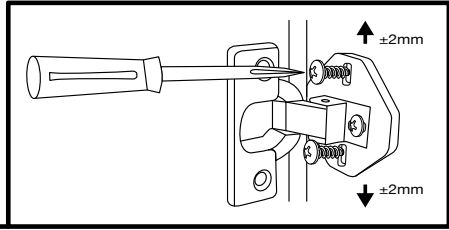

BEKO UK AND IRELAND STANDARD MANUFACTURER GUARANTEE TERMS AND CONDITIONS

Your new Beko product is guaranteed against faulty materials, defective components or manufacturing defects.

The standard guarantee starts from the date of original purchase of the product and lasts for a period of twelve (12) months unless Beko plc (the “Manufacturer”) agrees to extend the guarantee for the product in writing.

If you have purchased an American style Fridge freezer, the standard guarantee starts from the date of original purchase of the product, and lasts for a period of twenty four (24) months unless Beko plc (the “Manufacturer”) agrees to extend the guarantee for the product in writing.

If you have any questions about the guarantee on your product (including how long it is valid), please contact your retailer or our contact centre on 0333 207 9710 (UK and Northern Ireland) or 01 862 3411 (Republic of Ireland)

This guarantee does not in any way diminish or affect your statutory rights in connection with the product. This guarantee is in addition to your statutory rights as a consumer. If you have any questions about these rights, please contact the retailer from which you purchased the product. In certain circumstances, it is possible that your statutory rights may offer additional or higher levels of protection than those offered under the terms of this guarantee.

What is covered by this guarantee?

- Repairs to the product required as a result of faulty materials, defective components or manufacturing defects.
- Functional replacement parts to repair a product.
- The costs of a Beko Approved Engineer to carry out the repair.

What is not covered?

- Transit and delivery damage.
- Cabinet or appearance parts, including but not limited to control knobs, flaps and handles.
- Accessories and/or consumable items including but not limited to ice trays, scrapers, cutlery baskets, filters and light bulbs.
- Repairs necessary as a direct or indirect result of:
 - Accidental damage, misuse or abuse of a product.
 - An attempted repair of a product by anyone other than a Beko Approved Engineer (the “Engineer”).
 - Installation or use of a product where such installation or use fails to meet the requirements contained in this guarantee or the User Instructions Booklet.
- Repairs to a product operated at any time on commercial or non-residential household premises (unless we have previously agreed to the installation environment).

This guarantee is limited to the cost of repairing the product. To the extent permitted by law, the Manufacturer does not accept and will not be held liable for any financial loss incurred in connection with the failure of any product to operate in accordance with the expected standards. Such financial loss includes but is not limited to loss arising from:

- Time taken off work.
- Damaged food, clothing or other items.
- Meals taken at restaurants or from takeaways.
- General compensation for inconvenience.

Important Notes

1. Your product is designed and built for domestic household use only.
2. The guarantee will automatically be void if the product is installed or is used in commercial or non-residential domestic household premises, unless we have previously agreed to the installation environment.
3. The product must be correctly installed, located and operated in accordance with the instructions contained in the User Instructions Booklet provided with your product.
4. Professional installation by a qualified Electrical Domestic Appliance Installer is recommended for all Washing Machines, Dishwashers and Electric Cookers (as incorrect installation may result in you having to pay for the cost of repairing the product).
5. Gas Cookers must be professionally installed by a Gas Safe (or Gas Networks Ireland for Republic of Ireland) registered gas installer.
6. This guarantee is given in respect of products purchased and used within the United Kingdom and the Republic of Ireland.
7. This guarantee is effective from the initial date of purchase of a new product from an authorised retailer and will be void if the product is resold.
8. This guarantee does not apply to graded sales (where the product is purchased as a "second").
9. Possession of a copy of these terms and conditions does not necessarily mean that a product has the benefit of this guarantee. If you have any questions, please call our Call Centre on the number set out above.
10. The Manufacturer reserves the right to terminate the guarantee if its staff or representatives are subjected to physical or verbal abuse in the course of carrying out their duties.
11. Optional extras, where available (i.e. extendable feet) are supplied on a chargeable basis only.

Does Beko offer replacements?

This is a repair-only guarantee. On occasion, the Manufacturer may at its sole discretion, replace your product with a new product instead of carrying out a repair. Where a replacement is offered, this would normally be an identical model but when this is not possible, a model of similar specification will be provided. The Manufacturer will cover the costs and arrange for the delivery of the new product and for the return of the old product. Any costs related to disconnecting the faulty product and installing the replacement product will not be borne by the Manufacturer unless previously agreed to in writing. The original guarantee will continue to apply to the replacement product; the new product will not come with a new guarantee.

When will the repair take place?

Our Engineers work Monday to Friday 9.00am to 5.00pm. Appointments outside these hours may be possible at the sole discretion of the Manufacturer but cannot be guaranteed. Whilst our Engineers will endeavour to minimize inconvenience and to meet requests for specific timed appointments, this cannot be guaranteed. We will not be liable for delays or if it is unable to carry out a repair because a convenient appointment cannot be arranged.

Will there be any charge for the repairs?

It is your responsibility to provide evidence to the Engineer that your product is covered by this guarantee with a proof of purchase. The Manufacturer reserves the right to charge for the reasonable cost of any service call if:

- You cannot provide evidence that your product is covered by this guarantee.

- Where a service call has been made and the engineer finds that there is no fault with your product.
- That your product has not been installed or operated in accordance with the User Instructions Booklet.
- That the fault was caused by something other than faulty materials, defective components or manufacturing defects.
- For missed appointments.

Payment of these costs are due immediately upon the Engineer providing you with an invoice. The Manufacturer reserves the right to terminate the guarantee if you fail to pay the costs for the service call in a timely manner.

If you are a resident of the United Kingdom, this guarantee will be governed by English law and subject to the English Courts, save where you live in another part of the United Kingdom, in which case the law and courts of that location will apply.

If you are resident in the Republic of Ireland, this guarantee will be governed by Irish law and the Irish courts will have jurisdiction.

This guarantee is provided by Beko plc. Beko House, 1 Greenhill Crescent, Watford, Hertfordshire. WD18 8QU.

Beko plc is registered in England and Wales with company registration number 02415578.

BEKO UK AND IRELAND BUILT-IN APPLIANCES GUARANTEE TERMS AND CONDITIONS

If you have purchased a built-in or integrated appliance, and registered it within 90 days of purchase by completing the online registration form, then the standard 12 month guarantee will be extended to 24 months, under the same terms and conditions as detailed in our Standard Guarantee Terms and Conditions.

BEKO UK AND IRELAND PROSMART INVERTER MOTOR GUARANTEE TERMS AND CONDITIONS

This 10 year guarantee relates to Beko products that feature the ProSmart Inverter Motor.

The ProSmart Motor guarantee terms and conditions are in addition to our Standard guarantee terms and conditions detailed in the previous section.

In order to activate the 10 year guarantee you MUST register the appliance within 90 days of the original purchase date. You can register by first visiting Beko.co.uk/register and by following the online instructions.

Beko Free standing appliances come with a 12 month parts and labour guarantee as standard,

Beko Built-in appliances come with a 12 month parts and labour guarantee as standard. This is extended to 24 months, free of charge, upon registration of the appliance. When you register your appliance for additional guarantee, you will automatically activate the ProSmart Motor 10 year guarantee. You do not need to register twice. (beko.co.uk/guarantee-terms).

To make a claim against your Beko ProSmart Inverter Motor Guarantee (the "Guarantee"), all customer and product details must be registered with Beko plc using the procedure outlined below.

1. This extra 9 years (for free standing appliances) or 8 years (for built-in or integrated appliances) guarantee is only effective after the expiration of the standard manufacturer's guarantee.

2. It is only valid for the ProSmart Inverter motors of selected washing machines, washer-dryers, tumble dryers and dishwashers. It does not cover any labour charge or any other components of the product. In addition, it is only valid for one replacement of the ProSmart motor during the extra 9-year (for free standing appliances) or 8 year (for built-in appliances) guarantee period.
3. To activate your guarantee, you MUST register your appliance within 90 days of the original purchase date, by visiting beko.co.uk/register.
4. Customers will receive a unique reference code as proof of guarantee validation by email or post, which must be quoted at the time of a claim being made.
5. Any repair/replacement of the ProSmart Inverter motor must only be carried out by an authorised Beko Service Agent (the "Service Agent").
6. Labour for the repair/replacement of the ProSmart Inverter motor is not included in this guarantee and is chargeable directly by the Service Agent.
7. Any additional components fitted to the product at any time will not be covered by this guarantee and will be chargeable directly by the Service Agent.
8. The guarantee is not transferable and cannot be exchanged for cash.
9. There are no alternative or additional offers to this Guarantee.
10. The guarantee is exclusive of the manufacturer's standard guarantee
11. The Terms and Conditions shown above are in addition to the standard terms and conditions of your product guarantee. Please read and refer to such Terms and Conditions when making any claim.
12. We may use the information you provide for marketing purposes and to analyse your purchasing preferences. We may keep your information for a reasonable period for these purposes in accordance with the applicable Data Protection Laws and General Data Protection Regulations (GDPR). You can opt into this service during the registration process. Further details are available at <http://www.beko.co.uk/cookie-and-privacy>.
13. These Terms and Conditions are governed by the laws of England and Wales; manufacturer: Beko plc, Beko House, 1 Greenhill Crescent, Watford WD18 8QU. Company Registration Number: 02415578.

HOW TO OBTAIN SERVICE FOR YOUR APPLIANCE

Please keep your purchase receipt or other proof of purchase details in a safe place; you will need to have this documentation available should the product require attention under guarantee.

Please take a few moments to complete the details below, as you will need this information when you call us, or to use our online services. When you call us you may be required to input your serial number into your telephone keypad. For help please visit beko.co.uk/support/model-finder

- The product model number is printed on the Operating Instruction Booklet / User guide
- The product model and serial number is printed on the Rating Label affixed to the appliance.
- The Retailer (Purchased from) and Date of purchase will be printed on your purchase receipt or other proof of purchase paperwork

Recording of these details alone will not count as proof of purchase. A valid proof of purchase is required for requesting service under guarantee.

Model number	Serial number	Purchased from	Date of purchase

For service under guarantee or for product advice please call our Contact centre

Before requesting service please check the troubleshooting guide in the Operating Instructions booklet, as a charge may be levied where no fault is found, and even though your product may still be under guarantee.

After arranging service the area around the product must be easily accessible to the Engineer, without the need for cabinets or furniture to be removed or moved.

It is your responsibility to ensure our Engineers have a clean and safe environment to carry out any repairs.

Please have your Model number and Serial number available when you call us, as you may be required to input your serial number into your telephone keypad during your call.

UK Mainland & Northern Ireland:**0333 207 9710**

Landline or mobile calls to 0333 numbers cost no more than calls to geographic numbers 01 or 02, and are charged at the basic rate. Calls from landlines and mobiles are included in free call packages but please check with your telephone service provider for exact call charges.

Republic of Ireland:**01 862 3411****Service once the manufacturers guarantee has expired**

If you have purchased an extended guarantee please refer to the instructions contained within the extended guarantee agreement document, otherwise please call us using the appropriate number above, where service can be obtained at a charge.

Should you experience any difficulty in obtaining service please call us on **0333 207 9710** or **01 862 3411**

Contact us though our website

Send us a secure message through our online contact us form. Please visit our website, click Contact Us and choose a product support topic from the list of options. Complete the required details and click send message.

Product registrations

For UK registrations please visit beko.co.uk/register and for the Republic of Ireland visit beko.ie/register.

