



ZFS3584W
ZFS4584W

en

Instruction Manual



Please read these instructions first before using your appliance

Thank you for choosing a Beko appliance.

Please take some time to read this user manual before using your appliance, to ensure you know how to safely operate the controls and functions.

Carefully follow all unpacking and installation instructions to ensure the appliance is correctly connected and fitted prior to use.



Please write your product model and serial number on the last page of this user manual, and store in a safe location close to the appliance for easy future reference.





This user manual may also be applicable for several other models. Differences between models will be listed.

If you have any questions or concerns, please call our contact centre or find help and information online at www.beko.co.uk

Symbols and their descriptions

This instruction manual contains the following symbols:

-  Important information or useful usage tips.
-  Warning against dangerous conditions for life and property.
-  Warning against electric voltage.

 INFORMATION	
	
SUPPLIER'S NAME	MODEL IDENTIFIER (*)
	

The model information as stored in the product data base can be reached by entering following website and searching for your model identifier (*) found on energy label.

<https://eprel.ec.europa.eu/>

1 Your refrigerator	4	5 Using your refrigerator	15
2 Safety and Environment Instructions	5	Defrosting of the appliance	15
General Safety	5	Storing Frozen Food	15
Intended Use	7	Freezing Fresh Food	15
Child Safety	8	Making ice cubes.....	16
Compliance with WEEE Directive and Disposing of the Waste Product	8	How to Freeze Fresh Foods	16
Compliance with RoHS Directive.....	8	Recommendations for Preservation of	18
Package Information	8	Deep Freezer Information.....	18
3 Installation	9	Defrosting the frozen foods	18
Transportation Instructions.....	9	Recommended Temperature Settings	19
Installation Instructions	9	6 Maintenance and cleaning	22
Reversing the doors.....	11	7 Do's and Don'ts	23
4 Before operating	13	Problem Solving	24
Final Check	13		
Temperature Control And Adjustment	14		

1 Your freezer

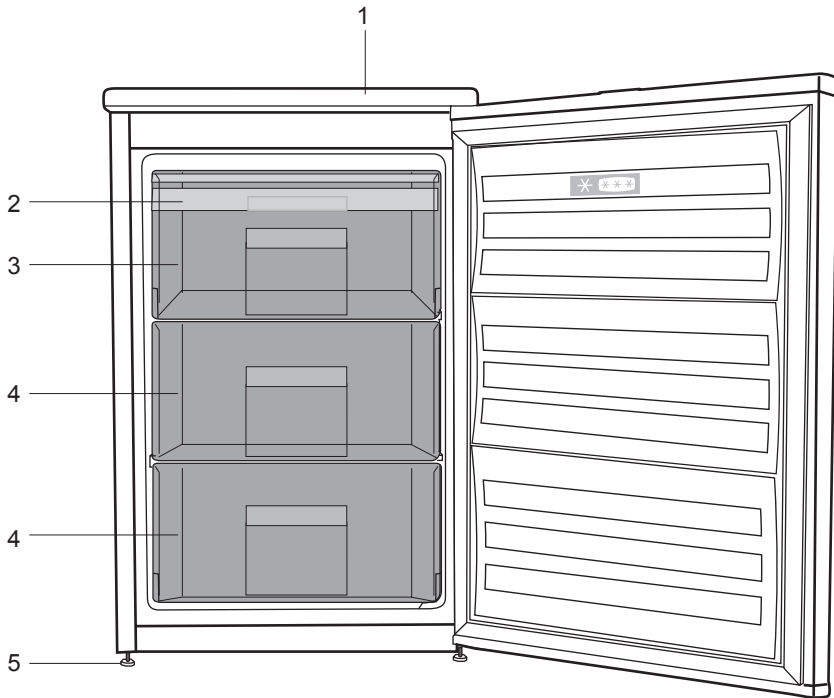





1. Top trim
2. Ice bank
3. Fast-freeze compartment
4. Frozen-food compartments
5. Adjustable front feet

i Figures that take place in this instruction manual are schematic and may not correspond exactly with your product. If the subject parts are not included in the product you have purchased, then it is valid for other models.

This section provides the safety instructions necessary to prevent the risk of injury and material damage. Failure to observe these instructions will invalidate all types of product warranty.

Intended use

	<p>WARNING: Keep ventilation openings, in the appliance enclosure or in the built-in structure, clear of obstruction.</p>
	<p>WARNING: Do not use mechanical devices or other means to accelerate the defrosting process, other than those recommended by the manufacturer.</p>
	<p>WARNING: Do not damage the refrigerant circuit.</p>
	<p>WARNING: Do not use electrical appliances inside the food storage compartments of the appliance, unless they are of the type recommended by the manufacturer.</p>
	<p>WARNING: Do not store explosive substances such as aerosol cans with a flammable propellant in this appliance.</p>

General Safety

- This product should not be used by persons with physical, sensory and mental disabilities, without sufficient knowledge and experience or by children. The device can only be used by such persons under supervision and instruction of a person responsible for their safety. Children should not be allowed to play with this device.
- In case of malfunction, unplug the device.
- After unplugging, wait at least 5 minutes before plugging in again.
- Unplug the product when not in use.
- Do not touch the plug with wet hands! Do not pull the cable to plug off, always hold the plug.
- Do not plug in the refrigerator if the socket is loose.
- Unplug the product during installation, maintenance, cleaning and repair.
- If the product will not be used for a while, unplug the product and remove any food inside.
- Do not use the product when the compartment with circuit cards located on the upper back part of the product (electrical card box cover) (1) is open.

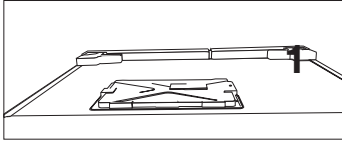
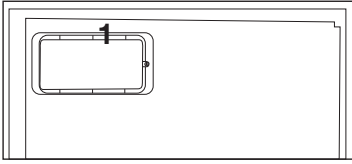

- Do not use steam or steamed cleaning materials for cleaning the refrigerator and melting the ice inside. Steam may come into contact with the electrified areas and cause short circuit or electric shock!
- Do not wash the product by spraying or pouring water on it! Danger of electric shock!
- In case of malfunction, do not use the product, as it may cause electric shock. Contact the authorized service before doing anything.
- Plug the product into an earthed socket. Earthing must be done by a qualified electrician.
- If the product has LED type lighting, contact the authorized service for replacing or in case of any problem.
- Do not touch frozen food with wet hands! It may adhere to your hands!
- Do not place liquids in bottles and cans into the freezer compartment. They may burst out!
- Place liquids in upright position after tightly closing the lid.
- Do not spray flammable substances near the product, as it may burn or explode.

- Do not keep flammable materials and products with flammable gas (sprays, etc.) in the refrigerator.
- Do not place containers holding liquids on top of the product. Splashing water on an electrified part may cause electric shock and risk of fire.
- Exposing the product to rain, snow, sunlight and wind will cause electrical danger. When relocating the product, do not pull by holding the door handle. The handle may come off.
- Take care to avoid trapping any part of your hands or body in any of the moving parts inside the product.
- Do not step or lean on the door, drawers and similar parts of the refrigerator. This will cause the product to fall down and cause damage to the parts.
- Take care not to trap the power cable.

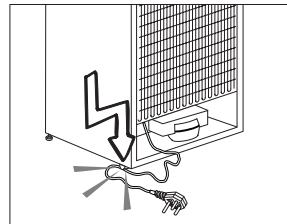

- When positioning the appliance, ensure the supply cord is not trapped or damaged.
- Do not locate multiple portable socket-outlets or portable power supplies at the rear of the appliance.

- Children aged from 3 to 8 years are allowed to load and unload refrigerating appliances.
- To avoid contamination of food, please respect the following instructions:
 - – Opening the door for long periods can cause a significant increase of the temperature in the compartments of the appliance.
 - – Clean regularly surfaces that can come in contact with food and accessible drainage systems.
 - – Clean water tanks if they have not been used for 48 h; flush the water system connected to a water supply if water has not been drawn for 5 days.
 - – Store raw meat and fish in suitable containers in the refrigerator, so that it is not in contact with or drip onto other food.
 - – Two-star frozen-food compartments are suitable for storing pre-frozen food, storing or making icecream and making ice cubes.
 - – One-, two- and three-star compartments are not suitable for the freezing of fresh food.
 - – If the refrigerating appliance is left empty for long periods, switch off, defrost, clean, dry, and leave the door open to prevent mould developing within the appliance.

1.1.1 HC Warning

If the product comprises a cooling system using R600a gas, take care to avoid damaging the cooling system and its pipe while using and moving the product. This gas is flammable. If

the cooling system is damaged, keep the product away from sources of fire and ventilate the room immediately.



1.1.2 For Models with Water Dispenser

- Pressure for cold water inlet shall be maximum 90 psi (6.2 bar). If your water pressure exceeds 80 psi (5.5 bar), use a pressure limiting valve in your mains system. If you do not know how to check your water pressure, ask for the help of a professional plumber.
- If there is risk of water hammer effect in your installation, always use a water hammer prevention equipment in your installation. Consult Professional plumbers if you are not sure that there is no water hammer effect in your installation.
- Do not install on the hot water inlet. Take precautions against of the risk of freezing of the hoses. Water temperature operating interval shall be 33°F (0.6°C) minimum and 100°F (38°C) maximum.
- Use drinking water only.

Intended Use

- This product is designed for home use. It is not intended for commercial use.
- The product should be used to store food and beverages only.
- Do not keep sensitive products requiring controlled temperatures (vaccines, heat sensitive medication, medical supplies, etc.) in the refrigerator.

- The manufacturer assumes no responsibility for any damage due to misuse or mishandling.
- Original spare parts will be provided for 10 years, following the product purchasing date.

Child Safety

- Keep packaging materials out of children's reach.
- Do not allow the children to play with the product.
- If the product's door comprises a lock, keep the key out of children's reach.

Compliance with WEEE Directive and Disposing of the Waste Product

This product complies with EU WEEE Directive (2012/19/EU). This product bears a classification symbol for waste electrical and electronic equipment (WEEE).

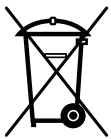

This product has been manufactured with high quality parts and materials which can be reused and are suitable for recycling.

Do not dispose of the waste product with normal domestic and other wastes at the end of its service life. Take it to the collection center for the recycling of electrical and electronic equipment. Please consult your local authorities to learn about these collection centers.

Compliance with RoHS Directive

- This product complies with EU WEEE Directive (2011/65/EU). It does not contain harmful and prohibited materials specified in the Directive.

Package Information

Packaging materials of the product are manufactured from recyclable materials in accordance with our National Environment Regulations. Do not dispose of the packaging materials together with the domestic or other wastes. Take them to the packaging material collection points designated by the local authorities.

3 Installation

Transportation Instructions

1. The appliance should be transported only in a vertical upright position. The packing as supplied must be intact during transportation.

2. If during the course of transport the appliance has to be transported horizontally, it must only be laid on its right hand side when standing in the front of the appliance. After bringing it to upright position, it must not be operated for at least 4 hours to allow the system to settle.

3. Failure to comply with the above instructions could result in damage occurring to the appliance. The manufacturer will not be held responsible if these instructions are disregarded.

4. The appliance must be protected against rain, moisture and other atmospheric influences.

5. Empty any water in the drain tray before moving see section "Defrosting" and "Cleaning & Care" for further information

Important: Make sure the plastic evaporating pan at the back of the product collects water properly.

Important: Care must be taken while cleaning / carrying the appliance to avoid touching the bottom of the condenser metal wires at the back of the appliance as you might injure your fingers and hands

Important: This appliance is not designed for stacking with any other appliance. When positioning your appliance, take care not to damage

your flooring, pipes, wall coverings etc. Do not move the appliance by pulling by the door or handle. Do not attempt to sit or stand on top of your appliance as it is not designed for such use. You could injure yourself or damage the appliance.

Important: Make sure that mains cable is not caught under the appliance during and after carrying / moving the appliance, to avoid the mains cable becoming cut or damaged. "Do not allow children to play with the appliance or tamper with the controls.

BEKO declines to accept any liability should the instructions not be followed.

Installation Instructions

1. If possible avoid placing the appliance near cookers, radiators or in direct sunlight as this will cause the compressor to run for long periods. If installed next to a source of heat or refrigerator, maintain the following minimum side clearances:

From Cookers 2" (50 mm)

From Radiators 12" (300 mm)

From Refrigerators or Larder Fridge 1" (25 mm)

2. No gap is required at sides and top. See item 3 below to ensure a gap is obtained at the rear of the appliance. If a gap is available on side and top, retain it if possible as it would improve the air circulation around the appliance.

3. Fit the two plastic wall spacers supplied with the appliance on to the condenser at the back of the

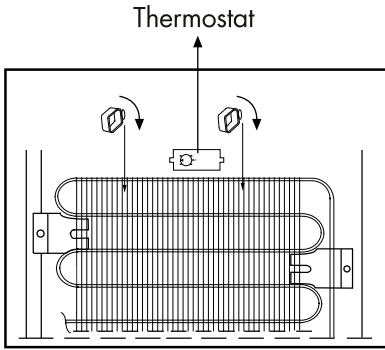

refrigerator by rotating 1/4 turn (see diagram).

4. The appliance should be located on a smooth surface. The two front feet can be adjusted as required. To ensure that, your appliance is standing upright adjust the two front feet by turning clockwise or anti-clockwise, until the product is in firm contact with the floor. Correct adjustment of feet avoids excessive vibration and noise.

5. Refer to "Cleaning and Care" section to prepare your appliance for use.

6. This appliance has been designed to operate in ambient temperatures between +10 and +32 degrees C (50 and 90 degrees F). However if the appliance is installed in an unheated / cold room (E.g.: Conservatory /annex / shed / garage etc.) it will still operate satisfactorily thanks to Freezer Guard system developed by Beko, down to -15°C ambient temperature.

7. A special receptacle is supplied to store the mains plug during transit. The receptacle is fixed at the back of the cabinet, on the right hand side of the compressor. (See diagram) Gently remove the plug from the receptacle.

Never pull the mains cord, you may damage the appliance. In the case of transportation, ensure you locate

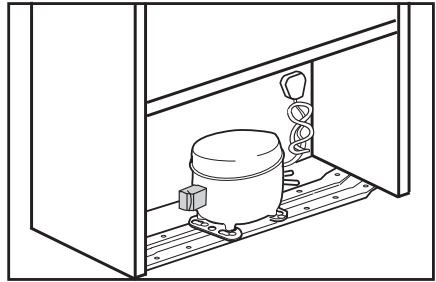

the plug in the receptacle provided to avoid transit damage.

8. The space in the room where the appliance is installed must not be smaller than 10 cubic metres.

Reversing the doors

Proceed in numerical order

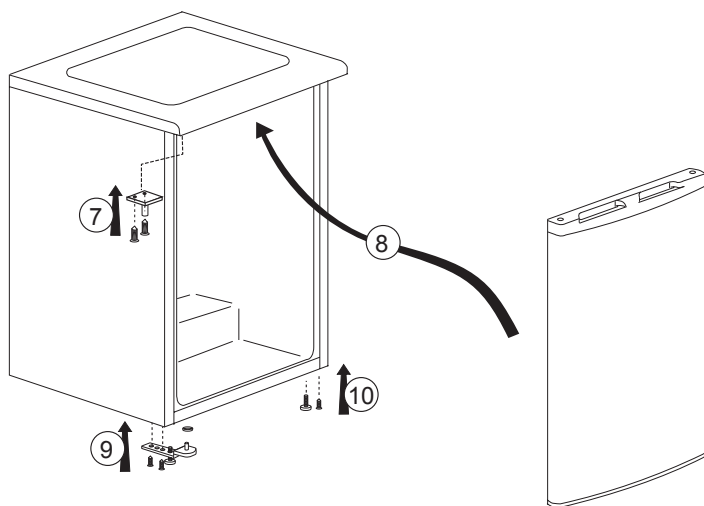
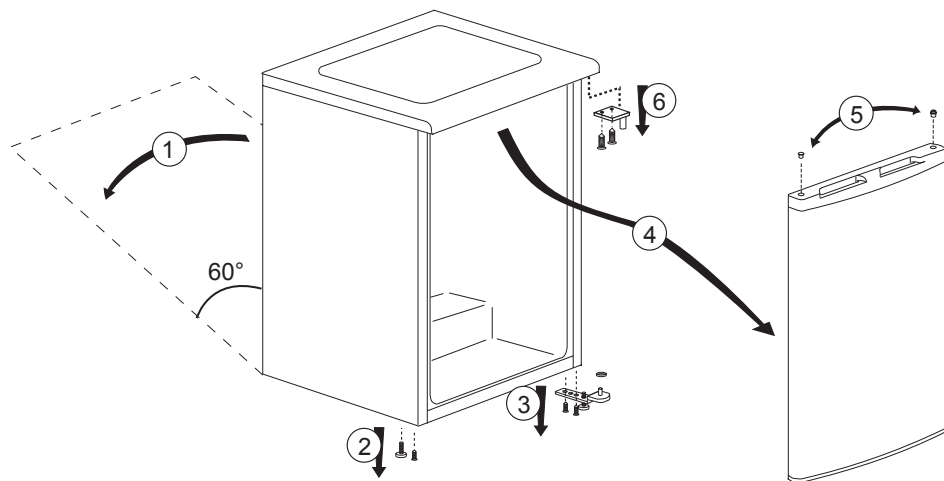

1. Switch off at the socket outlet and pull out the mains plug.

2. Remove all food, loose items and fittings from inside the appliance and door shelves.

3. Carefully tilt the appliance on its back side. (1) (You may need somebody to help you.) Take care not to damage the appliance by laying on some protective material (e.g. its original packaging). Make sure that you tilt the appliance on its back side, otherwise compressor oil may block the pipes and you may damage the appliance.

4. Unscrew and remove the LHS front feet and bolt (2).

5. Unscrew the bolts and remove the bottom hinge while holding the door (3).

6. Remove the door carefully from the top hinge by sliding down wards (4).

7. Reposition top hinge bushing and blanking plug on the opposite side and stand the door safely (5). You may find it easier to remove the bushing and the plug with the tip of a small screwdriver. Take care not to mark the door.

8. Reposition the top hinge on the opposite side (6 and 7).

9. To refit the door, locate the top hinge in the door, attach to the cabinet and hold the door (8).

10. Fit the bottom hinge (9). If necessary adjust and then tighten the bolts. Ensure, that the door opens and closes easily and that there are no gaps allowing air into the cabinet. If there are gaps between the door seal and the cabinet, adjust the door seal by gently pulling away from the door using fingers.

11. Fit the other front feet (10).

12. Carefully stand your appliance. (You may need somebody to help you.) Adjust the front feet (See Installation Instructions)

13. Put back all, loose items and fittings.

14. Wait for at least 4 hours to allow the system to settle before switching on. Spare plastic parts supplied with the appliance are for your future use during door repositioning.

4 Before operating

Final Check

Before you start using the fridge/freezer check that:

1. The feet have been adjusted for perfect levelling.
2. The interior is dry and air can circulate freely at the rear.
3. Clean the interior as recommended under "CLEANING AND CARE."
4. Insert the plug into the wall socket and switch on the electricity supply. Avoid accidental disconnection by taping over the switch.
5. You will hear a noise as the compressor starts up. The liquid and gases sealed within the refrigeration system may also give rise to noise, whether the compressor is running or not which is quite normal.
6. If you are going to store already frozen food you don't need to change the thermostat setting.
7. Slight undulation of the top of the cabinet is quite normal due to the manufacturing process used, so do not worry, it is not a defect.
8. Front edges of the cabinet may feel warm. This is normal. These areas are designed to be warm to avoid condensation.
9. We recommend that you set the thermostat knob at 3 and monitor the temperature to ensure the appliance maintains desired storage temperatures (see section Temperature Control and Adjustment).

10. Do not load the appliance immediately after it is switched on. Wait until the correct storage temperature has been reached. We recommend that you check the temperature with an accurate thermometer (see; Temperature Control and Adjustment).

Important Notes :

1. If there is a power failure do not open the door. Frozen food should not be affected if the failure lasts for less than 13 hours. If the failure is longer, then the food should be checked and either eaten immediately or cooked and then re-frozen.
2. If you find the freezer door difficult to open just after you have closed it, don't worry. This is due to the pressure difference which will equalise and allow the door to open normally after a few minutes.
3. Always wrap food using a suitable packaging material before storing in your appliance to avoid contact with the appliance surface and food remains for hygiene reasons.

Temperature Control And Adjustment

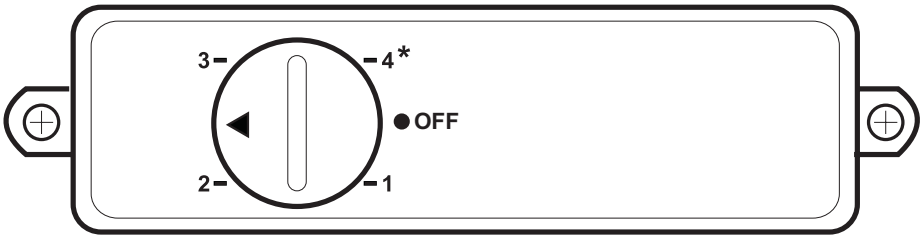

Temperature is controlled by the thermostat which is located on the rear wall of the cabinet (see the diagram on page 5). Thermostat knob is located on the thermostat housing. "Number 4" is the coldest setting. The normal storage temperature of your appliance should be -18°C (0°F). Lower temperatures may be obtained by adjusting the thermostat knob towards 'number 4' position.

We recommend that you check the temperature with a thermometer to ensure that the storage compartments are kept to the desired temperature.

Remember you must take your reading very quickly since the thermometer temperature will rise very rapidly after you remove it from the freezer.

Please remember each time the door is opened cold air escapes and the internal temperature rises. Therefore never leave the door open and ensure it is closed immediately after food is put in or removed.

5 Using your freezer

Defrosting of the appliance

Defrost twice a year or when a frost layer of around 7 mm (1/4") has formed.

To start defrosting procedure turn the thermostat knob to zero position (Alternatively you may switch off the freezer at the socket outlet and pull out the mains plug.)

All food should be wrapped in several layers of newspaper and stored in a cool place (e.g. fridge or larder).

Remove all freezer drawers. The special defrost collection basin collects the defrost water. Therefore defrosting can be conducted without mess.

Containers full of warm water may be placed carefully in the freezer to speed up the defrosting.

Do not use pointed or sharp edged objects such as knives, forks to remove the frost.

Never use hairdryers, electrical heaters and other similar electrical appliances for defrosting.

When defrosting has finished, sponge out any defrost water which collects at the bottom of the freezer and dry the interior thoroughly. Turn the thermostat knob to 2. Close the freezer door. Insert the plug into the wall socket and switch on the electricity supply. Don't forget to tape over the switch to avoid accidental disconnection.

Storing Frozen Food

Prepacked commercially frozen food should be stored in accordance with the frozen food manufacturer's instructions for a ❄️ frozen food storage compartment.

The freezing area is marked with ❄️ symbol on the door liner.

To ensure that the high quality achieved by the frozen food manufacturer and the food retailer is maintained the following should be remembered:

1. Put packets in the freezer as quickly as possible after purchase.
2. Do not exceed "Use By", "Best Before" dates on the packaging.
3. Please note that drawers, baskets, flaps, trays are all removable.

Freezing Fresh Food

Freezing capacity of your appliance in a 24 hours period is 10.5 kg (23 lb). Never exceed this maximum capacity.

If you are using the maximum freezing capacity, turn the thermostat knob to position 4.

Fast freeze compartment (3) is shown in diagram.

Take special care not to mix already frozen food and fresh food.

If the fast freeze compartment (3) is filled with fresh food, other compartments can also be used to freeze fresh food.

Making ice cubes

Fill the ice-cube tray 3/4 full with water and place it in the freezer.

As soon as the water has turned into ice, you can take out the ice cubes.

Never use sharp objects such as knives or forks to remove the ice cubes. There is a risk of injury!

Let the ice cubes slightly thaw instead, or put the bottom of the tray in hot water for a short moment.

Warning:

Do not use any copper pots or dishes inside the cabinet!

Do not load any food without packaging.!

How to Freeze Fresh Foods

- Foods to be frozen must be divided into portions according to a size to be consumed, and frozen in separate packages. In this way, all the food should be prevented from being re-frozen by thawing.
- In order to protect the nutritional value, the aroma and the color of the foods as much as possible, vegetables should be boiled for a short period of time before freezing. (Boiling is not necessary for foods such as cucumber, parsley.) Cooking time of the vegetables frozen in this way is shortened by 1/3 than that of the fresh vegetables.
- To extend the storage times of frozen foods, boiled vegetables must first be filtered and then hermetically packaged as in the all types of foods.
- Foods should not be placed in the freezer compartment without package.
- The packaging material of the food to be stored should be air-tight, thick and durable and should not deform with cold and humidity. Otherwise, the food that is hardened by freezing might pierce the package. Sealing the package well is also important in terms of securely storing the food.

The following packaging types are suitable for use to freeze the food:

Polyethylene bag, aluminum foil, plastic foil, vacuum bags and cold-resistant storage containers with caps.

The use of the following types of packaging is not recommended to freeze the food;

Packaging paper, parchment paper, cellophane (gelatin paper), garbage bag, used bags and shopping bags.

- Hot foods should not be placed in the freezer compartment without cooling.
- When placing unfrozen fresh foods in the freezer compartment, please note that it does not contact with frozen foods. Cool-pack (PCM) (if any) can be placed to the rack immediately below the quick freezer rack for preventing them from being getting warm.
- During the freezing time (24 hours) do not place other food to the freezer.
- Place your foods to the freezing shelves or racks by spreading them so that they will not be cramped (it is recommended that the packaging does not come into contact with each other).
- Frozen foods must be immediately consumed in a short period of time after defrosting and must never be frozen again.
- We recommend you to attach a label onto the package and write the name of the foods in the package and the freezing time.

Foods suitable for freezing:

- Fish and seafood, red and white meat, poultry, vegetables, fruit, herbaceous spices, dairy products (such as cheese, butter and strained yoghurt), pastries, ready or cooked

meals, potato dishes, souffle and desserts.

- Foods not suitable for freezing:
 - Yoghurt, sour milk, cream, mayonnaise, leaved salad, red radish, grapes, all fruits (such as apple, pears and peaches).
 - For foods to be frozen quickly and thoroughly, the following specified amounts per package should not be exceeded.
 - Fruits and vegetables, 0.5-1 kg
 - Meat, 1-1.5 kg
 - A small amount of foods (maximum 2 kg) can also be frozen without the use of the quick freezing function.

To obtain the best result, apply the following instructions:

- 1.** Switch the adjusting knob to MAX or 4 position 24 hours before placing your fresh foods to freeze.
- 2.** 24 hours after turning the thermostat knob, place your food that you want to freeze to the front of top drawer with higher freezing capacity. If you have food remained, place them to the sides of the middle section.
- 3.** Do not forget to turn the thermostat knob to its previous position, after placing your food.
- 4.** Do not try to freeze a large quantity of food at a time. Within 24 hours, this product can freeze the maximum food quantity specified as «Freezing Capacity 10.5 kg/24 hours» on its type label. It is not convenient to put more unfrozen/fresh foods to the freezer compartment than the quantity specified on the label.

- You can review the Meat and Fish, Vegetables and Fruits, Dairy Products tables for placing and storing your foods in the deep-freezer.

Recommendations for Preservation of

Frozen Foods

- While purchasing your frozen foods, make sure that they are frozen at appropriate temperatures and their packages are not broken.
- Put the packages on the freezer compartment as soon as possible after purchasing them.
- Make sure that the expiration date indicated on the packaging is not expired before consuming the packaged ready meals that you remove from the freezer compartment.

Deep Freezer Information

The EN 62552 standard requires (according to specific measurement conditions) that at least 4.5 kg of food for each 100 liter of freezer compartment volume can be frozen at a room temperature of 25°C in 24 hours.

Defrosting the frozen foods

Depending on the food diversity and the purpose of use, a selection can be made between the following options for defrosting:

- At room temperature (it is not very suitable to defrost the food by leaving it at room temperature for a long time in terms of maintaining the food quality)

- In the refrigerator
- In the electrical oven (in models with or without fan)
- In the microwave oven

CAUTION:

- Never put acidic beverages in glass bottles and cans into your freezer due to the risk of explosion.
- If there is moisture and abnormal swelling in the packaging of frozen foods, it is likely that they were previously stored in an improper storage condition and their contents deteriorated. Do not consume these foods without checking.
- Since some spices in cooked meals may change their taste when exposed to long-term storage conditions, your frozen foods should be less seasoned or the desired spices should be added to the foods after the thawing process.

Recommended Temperature Settings

Freezer compartment setting	Remarks
1.2	This is the default recommended temperature setting.
3	These settings are recommended when the ambient temperature is higher than 30°C or when you think the refrigerator is not cool enough due to frequent opening and closing of the door.
Quick freezing (MAX or 4*)	Use when you want to freeze your food in a short time. It is recommended to be applied to preserve the quality of your fresh food. You do not need to use the quick freezing function when putting your frozen food. You do not need to use the quick freezing function to freeze a small amount of fresh food, up to 2 kg per day.

Meat and Fish			Preparation	Longest storage time (month)
Meat products	Veal	Steak	By cutting them 2 cm thick and placing foil between them or wrapping tightly with stretch	6 - 8
		Roast	By packing the pieces of meat in a refrigerator bag or wrapping them tightly with stretch	6 - 8
		Cubes	In small pieces	6 - 8
		Schnitzel, chops	By placing foil between cut slices or wrapping individually with stretch	6 - 8
	Mutton	Chops	By placing foil between meat pieces or wrapping individually with stretch	4 - 8
		Roast	By packing the pieces of meat in a refrigerator bag or wrapping them tightly with stretch	4 - 8
		Cubes	By packing the shredded meats in a refrigerator bag or wrapping them tightly with stretch	4 - 8
	Beef	Roast	By packing the pieces of meat in a refrigerator bag or wrapping them tightly with stretch	8-12
		Steak	By cutting them 2 cm thick and placing foil between them or wrapping tightly with stretch	8-12
		Cubes	In small pieces	8-12
		B o i l e d meat	By packaging in small pieces in a refrigerator bag	8-12
	Mince		Without seasoning, in flat bags	1 - 3
	Offal (piece)		In pieces	1 - 3
	Fermented sausage - Salami		It should be packaged even if it has casing.	1-2
Jambon		By placing foil between cut slices	2-3	
Poultry and hunting animals	Chicken and Turkey		By wrapping in foil	4 - 6
	Goose		By wrapping in foil (portions should not exceed 2.5 kg)	4 - 6
	Duck		By wrapping in foil (portions should not exceed 2.5 kg)	4-6
	Deer, Rabbit, Roe Deer		By wrapping in foil (portions should not exceed 2.5 kg, and their bones should be separated)	6 - 8
Fish and seafood	Freshwater fish (Trout, Carp, Crane, Catfish)	After thoroughly cleaning the inside and scales, it should be washed and dried, and the tail and head parts should be cut when necessary.		2
	Lean fish (Sea bass, Turbot, Sole)			4-6
	Fatty fish (Bonito, Mackerel, Bluefish, Red Mullet, Anchovy)			2 - 4
	Shellfish		Cleaned and in bags	4 - 6
	Caviar		In its packaging, in an aluminum or plastic container	2 - 3

Fruits and Vegetables	Preparation	Longest storage time (month)
String bean and Pole bean	By shock boiling for 3 minutes after washing and cutting into small pieces	10 - 13
Green pea	By shock boiling for 2 minutes after shelling and washing	10-12
Cabbage	By shock boiling for 1-2 minute(s) after cleaning	6 - 8
Carrot	By shock boiling for 3-4 minutes after cleaning and cutting into slices	12
Pepper	By boiling for 2-3 minutes after cutting the stem, dividing into two and separating the seeds	8 - 10
Spinach	By shock boiling for 2 minutes after washing and cleaning	6 - 9
Leek	By shock boiling for 5 minutes after chopping	6-8
Cauliflower	By shock boiling in a little lemon water for 3-5 minutes after separating the leaves, cutting the core into pieces	10 - 12
Eggplant	By shock boiling for 4 minutes after washing and cutting into 2cm pieces	10 - 12
Squash	By shock boiling for 2- 3 minutes after washing and cutting into 2cm pieces	8-10
Mushroom	By lightly sauteing in oil and squeezing lemon on it	2-3
Corn	By cleaning and packing in cob or granular	12
Apple and Pear	By shock boiling for 2-3 minutes after peeling and slicing	8 - 10
Apricot and Peach	Divide in half and extract the seeds	4 - 6
Strawberry and Raspberry	By washing and shelling	8 - 12
Baked fruit	By adding 10% sugar in the container	12
Plum, Cherry, Sour Cherry	By washing and shelling the stalks	8 - 12

Dairy Products	Preparation	Longest Storage Time (Month)	Storage Conditions
Cheese (except feta cheese)	By placing foil between, in slices	6 - 8	It can be left in its original packaging for short term storage. For long-term storage it should also be wrapped in aluminum or plastic foil.
Butter, margarine	In its own packaging	6	In its own packaging or in plastic containers

6 Maintenance and cleaning

- We recommend that you switch off the appliance at the socket outlet and pull out the mains plug before cleaning.
- Never use any sharp abrasive instrument, soap, household cleaner, detergent and wax polish for cleaning.
- Use luke warm water to clean the cabinet of the appliance and wipe it dry.
- Use a damp cloth wrung out in a solution of one teaspoon of bicarbonate of soda to one pint of water to clean the interior and wipe it dry.
- Excess deposit of ice should be removed on a regular basis using the handle of a spoon. Large accumulation of ice will impair the performance of the freezer.
- If the freezer is not going to be used for a long period of time switch it off, remove all food, clean it and leave the door ajar.
- To remove a drawer, pull it as far as possible, and then tilt it upwards, and then pull it out completely.
- Any dust that gathers on the condenser, which is located at the back of the freezer, should be removed once a year with a vacuum cleaner.
- Check door seals regularly to ensure they are clean and free from food particles..
- Never :
Clean the worktop with unsuitable material; eg petroleum based products.
Subject it to hot temperatures in any way, Scour, rub etc., with abrasive material.

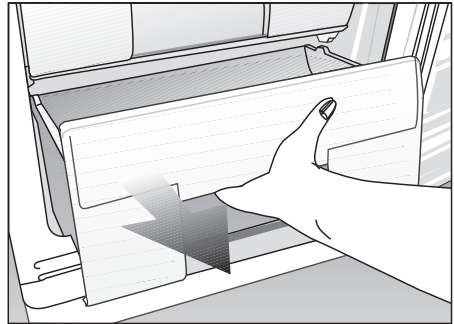

7 Do's and Don'ts

- Do- Clean your appliance regularly (See "Cleaning and Care")
- Do- Keep raw meat and poultry below cooked food and dairy products.
- Do- Take off any unusable leaves on vegetables and wipe off any soil.
- Do- Leave lettuce, cabbage, parsley and cauliflower on the stem.
- Do- Wrap cheese firstly in greaseproof paper and then in a polythene bag excluding as much air as possible. For best results take out of the fridge compartment an hour before eating.
- Do- Wrap raw meat and poultry loosely in polythene or aluminium foil. This prevents drying.
- Do- Wrap fish and offal in polythene bags.
- Do- Wrap food which have a strong odour or can dry out in polythene bags, aluminium foil or place in an airtight container.
- Do- Wrap bread well to keep it fresh.
- Do- Chill white wines, beer, lager and mineral water before serving.
- Do- Check contents of the freezer every so often.
- Do- Keep food for as short a time as possible and adhere to "Best Before", "Use by" etc. dates.
- Do- Store commercially frozen food in accordance with the instructions given on the packets that you buy.
- Do- Always choose high quality fresh food and be sure it is thoroughly clean before you freeze it.
- Do- Prepare fresh food for freezing in small portions to ensure rapid freezing.
- Do- Wrap all food in aluminium foil or freezer quality polythene bags and make sure any air is excluded.
- Do- Wrap frozen food when you buy it and put it in to the freezer as soon as possible.
- Do- Defrost food in the fridge compartment.
- Do- Remove ice cream from the freezer 10-20 minutes before serving.
- Don't- Store bananas in your fridge compartment.
- Don't- Store melon in your fridge. It can be chilled for short periods as long as it is wrapped to avoid it flavouring other food.
- Don't- Store poisonous or any dangerous substances in your appliance. It has been designed for the storage of edible foodstuffs only.
- Don't- Consume food which has been stored for an excessive time in the fridge.
- Don't- Store cooked and fresh food together in the same container. They should be packaged and stored seperately.
- Don't- Let defrosting food or food juices drip onto food.
- Don't- Leave the door open for long periods as this will make the appliance more costly to run and cause excessive ice formation.
- Don't- Put hot food into the appliance. Let it cool down first.
- Don't- Put liquid-filled bottles or sealed cans containing carbonated liquids into the freezer as they may burst.
- Don't- Exceed the maximum freezing loads (10,5 kg in any 24 hours) when freezing fresh food.
- Don't- Give children ice-cream and water ices direct from the freezer. The low temperature may cause 'freezer burns' on lips.

Don't- Freeze fizzy drinks.

Don't- Try to keep frozen food which has thawed, it should be eaten within 24 hours or cooked and refrozen.

Don't- Remove items from the freezer with wet hands.

Don't- Close the freezer door before placing the compartment cover in its place.

Don't- Leave frozen food at room temperature to thaw; the best way to defrost food is to put it in the fridge to thaw slowly. Make sure you avoid defrosting food or food juices drip onto other food.

Problem Solving

If the appliance does not operate when switched on, check whether:

- The plug is inserted properly in the socket and that the power supply is on. (To check the power supply to the socket, plug in another appliance)

- The fuse has blown/circuit breaker has tripped/main distribution switch has been turned off.

- The temperature control has been set correctly and not to "0" (OFF)

- New plug is wired correctly if you have changed the fitted moulded plug.

If the appliance is still not operating after the above checks, please refer to the section on "How To Obtain Service".

Please ensure that above checks have been made as a charge will be made if no fault is found.

Your new Zenith product is guaranteed against faulty materials, defective components or manufacturing defects. The guarantee starts from the date of original purchase of the product for a period of one (1) year, unless Beko plc (the "Manufacturer") agrees to extend the guarantee for the product in writing. If you have any questions about the guarantee on your product (including how long it is valid), please contact your retailer or our Call Centre on 0333 207 2028.

This guarantee does not in any way diminish or affect your statutory rights in connection with the product. This guarantee is in addition to your statutory rights as a consumer. If you have any questions about these rights, please contact the retailer from which you purchased the product. In certain circumstances, it is possible that your statutory rights may offer additional or higher levels of protection than those offered under the terms of this guarantee.

What is covered by this guarantee?

- Repairs to the product required as a result of faulty materials, defective components or manufacturing defects.
- Functional replacement parts to repair a product.
- The costs of a Zenith Approved Engineer to carry out the repair.

What is not covered?

- Transit and delivery damage.
- Cabinet or appearance parts, including but not limited to control knobs, flaps and handles.
- Accessories and/or consumable items including but not limited to ice trays, scrapers, cutlery baskets, filters and light bulbs.
- Repairs necessary as a direct or indirect result of:
 - Accidental damage, misuse or abuse of a product.
 - An attempted repair of a product by anyone other than a Zenith Approved Engineer (the "Engineer").
 - Installation or use of a product where such installation or use fails to meet the requirements contained in this guarantee or the product manual.
- Repairs to a product operated at any time on commercial or non-residential household premises (unless we have previously agreed to the installation environment).

This guarantee is limited to the cost of repairing the product. To the extent permitted by law, Beko plc (the "Manufacturer") does not accept and will not be held liable for any financial loss incurred in connection with the failure of any product to operate in accordance with the expected standards. Such financial loss includes but is not limited to loss arising from:

- Time taken off work.
- Damaged food, clothing or other items.
- Meals taken at restaurants or from takeaways.

- General compensation for inconvenience. Important Notes
- Your product is designed and built for domestic household use only.
- The guarantee will automatically be void if the product is installed or is used in commercial or non-residential domestic household premises, unless we have previously agreed to the installation environment.
 - The product must be correctly installed, located and operated in accordance with the instructions contained in the product manual provided with your product.
 - Professional installation by a qualified electrical domestic appliance installer is recommended for all washing machines, dishwashers and electric cookers (as incorrect installation may result in you having to pay for the cost of repairing the product).
 - Gas Cookers must be professionally installed by a Gas Safe (or Gas Networks Ireland for Republic of Ireland) registered gas installer.
 - This guarantee is given in respect of products purchased and used within the United Kingdom.
 - This guarantee is effective from the initial date of purchase of a new product from an authorised retailer and will be void if the product is resold.
 - This guarantee does not apply to graded sales (where the product is purchased as a second").
 - Possession of a copy of these terms and conditions does not necessarily mean that a product has the benefit of this guarantee. If you have any questions, please call our Call Centre on the number set out above.
 - The Manufacturer reserves the right to terminate the guarantee if its staff or representatives are subjected to physical or verbal abuse in the course of carrying out their duties.
 - Optional extras, where available (i.e. extendable feet) are supplied on a chargeable basis only.

Does Zenith offer replacements?

This is a repair-only guarantee. On occasion the Manufacturer may at its sole discretion, replace your product with a new product instead of carrying out a repair. Where a replacement is offered, this would normally be an identical model, but when this is not possible, a model of similar specification will be provided. The Manufacturer will cover the costs and arrange for the delivery of the new product and for the return of the old product. Any costs related to disconnecting the faulty product and installing the replacement product will not be borne by the Manufacturer unless previously agreed to in writing. The original guarantee will continue to apply to the replacement product; the new product will not come with a new guarantee.

When will the repair take place?

Our engineers work Monday to Friday 9.00am to 5.00pm. Appointments outside these hours may be possible at the sole discretion of the Manufacturer but cannot be guaranteed. Whilst our Engineers will endeavour to minimize inconvenience and to meet requests for specific timed appointments, this cannot be guaranteed. The Manufacturer will not be liable for delays or if it is unable to carry out a repair because a convenient appointment cannot be arranged.

Will there be any charge for the repairs?

It is your responsibility to provide evidence to the Engineer that your product is covered by this guarantee with a proof of purchase. The Manufacturer reserves the right to charge for the reasonable cost of any service call if:

- You cannot provide evidence that your product is covered by this guarantee.
- Where a service call has been made and the engineer finds that there is no fault with your product.
- That your product has not been installed or operated in accordance with the User

Instructions Booklet.

- That the fault was caused by something other than faulty materials, defective components or manufacturing defects.
- For missed appointments.

Payment of these costs are due immediately upon the Engineer providing you with an invoice. If you fail to pay the costs for the service call in a timely manner, the Manufacturer reserves the right to terminate the guarantee.

If you are a resident of the United Kingdom, this guarantee will be governed by English law and subject to the English Courts, save where you live in another part of the United Kingdom, in which case the law and courts of that location will apply.

HOW TO OBTAIN SERVICE

Please keep your purchase receipt or other proof of purchase in a safe place; you will need to have it should the product require attention under guarantee.

It will be useful if you complete the details below, as it will help us assist you when requesting service. (The model number is printed on the Instruction Booklet and the serial number is printed on the Rating Label affixed to the appliance). Recording of these details alone will not count as proof of purchase. A valid proof of purchase is required for under guarantee service.

The area around the product must be easily accessible to the Engineer without the need for cabinets or furniture being removed.

It is your responsibility to ensure our Engineers have a clean and safe environment to carry out any repairs.

Model No:

Serial No: Retailer:

Date of purchase:

For service under guarantee simply telephone the appropriate number below

UK Mainland & Northern Ireland: 0333 207 2028.

Register your appliance at <https://www.zenithappliance.co.uk>

Before requesting service please check the troubleshooting guide in the Operating Instructions as a charge may be levied where no fault is found even though your product may still be under guarantee.

Service once the manufacturer's guarantee has expired.

If you have purchased an extended guarantee please refer to the instructions contained within the extended guarantee agreement document, otherwise please call the appropriate number above where service can be obtained at a charge.

Should you experience any difficulty in obtaining service contact the Zenith Customer Helpline on Tel: 0333 207 2028 or email:

customerservice@support.zenithappliance.co.uk

This guarantee is provided by Beko plc. Beko House, 1 Greenhill Crescent, Watford, Herts, WD18 8QU. Beko plc is registered in England and Wales with company registration number 02415578.

